

Zeitschrift: Archives des sciences et compte rendu des séances de la Société
Herausgeber: Société de Physique et d'Histoire Naturelle de Genève
Band: 38 (1985)
Heft: 3

Artikel: The use of mutants and chimeras to explore the gradients underlying pattern formation in hydra
Autor: Achermann, Josef
DOI: <https://doi.org/10.5169/seals-740493>

Nutzungsbedingungen

Die ETH-Bibliothek ist die Anbieterin der digitalisierten Zeitschriften. Sie besitzt keine Urheberrechte an den Zeitschriften und ist nicht verantwortlich für deren Inhalte. Die Rechte liegen in der Regel bei den Herausgebern beziehungsweise den externen Rechteinhabern. [Siehe Rechtliche Hinweise.](#)

Conditions d'utilisation

L'ETH Library est le fournisseur des revues numérisées. Elle ne détient aucun droit d'auteur sur les revues et n'est pas responsable de leur contenu. En règle générale, les droits sont détenus par les éditeurs ou les détenteurs de droits externes. [Voir Informations légales.](#)

Terms of use

The ETH Library is the provider of the digitised journals. It does not own any copyrights to the journals and is not responsible for their content. The rights usually lie with the publishers or the external rights holders. [See Legal notice.](#)

Download PDF: 14.03.2025

ETH-Bibliothek Zürich, E-Periodica, <https://www.e-periodica.ch>

THE USE OF MUTANTS AND CHIMERAS TO EXPLORE THE GRADIENTS UNDERLYING PATTERN FORMATION IN HYDRA

BY

Josef ACHERMANN¹

ABSTRACT

Pattern forming processes in hydra are thought to be controlled by morphogenetic potentials which form gradients along the body column. Two types of morphogenetic potentials control head formation: the potential to form head structures (head-activation potential) and the potential to inhibit head formation (head-inhibition potential). The relative level of these potentials can be measured by the lateral grafting procedure. This method was used to examine and compare the relative level of the head-activation and the head-inhibition potentials in a standard wild-type strain (105) and three mutant strains of *Hydra magnipapillata*: a regeneration deficient strain (reg-16), a slow budding strain (L4) and a multiheaded strain (mh-1). The results obtained show that the potentials in all mutant strains are highly abnormal compared to the wild-type strain. The abnormalities are in good relation to the morphogenetic defects in these strains.

From a mutant strain, L4, and the wild type strain, 105, chimeric strains were constructed. Hydra tissue consists of three self proliferating cell lineages: the ectodermal epithelial, the endodermal epithelial and the interstitial cell lineage. Starting from a normal and a mutant strain as parental strains six chimeric strains can be constructed in a two step procedure. Each of these chimeras consists of two cell lineages from one of the parental strain and one cell lineage of the opposite strain.

The analysis of the morphogenetic potentials in these strains provides evidence which suggests that the head-activation potential is controlled by the ectodermal epithelial cell lineage, and that the head-inhibition potential is controlled by the endodermal epithelial and the interstitial cell lineages in these mutant strain. These results are supported by a similar analysis of reg-16/105 chimeras and by experiments with isolated ectodermal tissue transplants.

INTRODUCTION

A new approach to the study of developmental processes in hydra is the use of mutant strains which show abnormalities in cellular composition, morphology or certain morphogenetic processes. Mutant strains of *Hydra magnipapillata* were isolated successfully (Sugiyama and Fujisawa, 1977a), and are available for experimental use. Some of these strains are highly defective in budding or regeneration, or they show

¹ Zoologisches Institut der Universität Zürich, Winterthurerstrasse 190, CH-8057 Zürich, Switzerland.

formation of additional heads or tentacles along their body axis. Such strains are a valuable material to investigate the basic principles which govern such morphogenetic processes as budding, regeneration or head formation (Trembley, 1744; Gierer and Meinhardt, 1972; Wolpert *et al.*, 1974; MacWilliams, 1982).

Hydra tissue has two types of morphogenetic potentials to control head formation: the potential to form head structures (head-activation potential) and the potential to inhibit head formation (head-inhibition potential). The levels of both potentials are high near the head and low near the foot, forming gradients along the body column (Webster, 1966; Wolpert *et al.*, 1974; MacWilliams, 1983). When the head is removed, the levels of the two potentials show drastic and dynamic changes in the remaining body part during the process of regeneration (Webster, 1966; Wolpert *et al.*, 1974; MacWilliams, 1983). These and other observations lead to the current idea that these two potentials play important roles in head formation in hydra (Wolpert *et al.*, 1974; Meinhardt and Gierer, 1974). A comparable system consisting of a foot-activation and a foot-inhibition potential is supposed to control foot formation (MacWilliams *et al.*, 1970).

In an extensive study, the head-activation and head-inhibition potentials of three different mutant strains were examined by the lateral tissue grafting procedure described by Webster and Wolpert (1966). One of the strains, termed reg-16, shows a very reduced capacity to regenerate a head after amputation of the original head (Sugiyama and Fujisawa, 1977b). A second strain, termed L4, has a very low budding rate and a large polyp size (Sugiyama and Fujisawa, 1978). The third strain is a multi-headed strain, termed mh-1, which produces many extra heads along its body column (Sugiyama, 1982).

The results obtained in this study indicate that the morphogenetic potentials involved in head formation are highly abnormal in the mutant strains, when compared with a wild-type strain (strain 105). Reg-16 and L4 have both a significantly higher head-inhibition potential and a significantly lower or slightly lower, respectively, head-activation potential than the wild-type strain (Takano and Sugiyama, 1983; Achermann and Sugiyama, 1985). In contrary, mh-1 has a significantly higher head-activation and a significantly lower head-inhibition potential than the normal strain (Sugiyama, 1982). These results indicate a strong relationship between the potential abnormalities and the morphogenetic defects in these strains.

From two of these strains, L4 and reg-16, chimeric strains were constructed (Takano and Sugiyama, 1984; Wanek *et al.*, in preparation) using the interstitial cell elimination and reintroduction method by Marcum and Campbell (1978) and the ectodermal-endodermal migration method by Wanek and Campbell (1982). Hydra tissue consists of three self proliferating cell lineages: the ectodermal epithelial, the endodermal epithelial and the interstitial cell lineage. Using one of the mutant strain (e.g. L4) and the wild-type strain (105) as parental strains, six chimeric strains can be constructed, each of which consists of two of the original cell lineages and one

cell lineage of the opposite strain (e.g. L4 ectodermal, 105 endodermal, 105 interstitial) (Takano and Sugiyama, 1984). Such strains provide a means of examining which cell lineages are responsible for the abnormal morphogenetic potentials.

The study of the L4/105 chimeric strains provided evidence which suggests that the head-activation and the head-inhibition potentials in these strains are controlled by different cell lineages (Takano and Sugiyama, 1984). These results are well supported by results obtained by a comparable analysis of reg-16/105 chimeras (Wanek *et al.*, in preparation) and by results obtained by transplantation of isolated ectodermal tissue.

COMPARISON OF THE POTENTIAL LEVELS IN A WILD-TYPE AND IN MUTANT STRAINS

The levels of the morphogenetic potentials in hydra tissue can be assayed by the lateral tissue grafting method (Webster and Wolpert, 1966). When a piece of tissue is removed from one polyp and grafted onto the side of another polyp, it induces the formation of a secondary head, a secondary foot, or nothing. It is thought that head induction occurs when the head-activation potential of the donor tissue is sufficiently higher than the head-inhibition potential of the recipient tissue, whereas foot induction occurs when the foot-activation potential of the donor tissue is sufficiently higher than the foot inhibition potential of the recipient tissue (MacWilliams *et al.*,

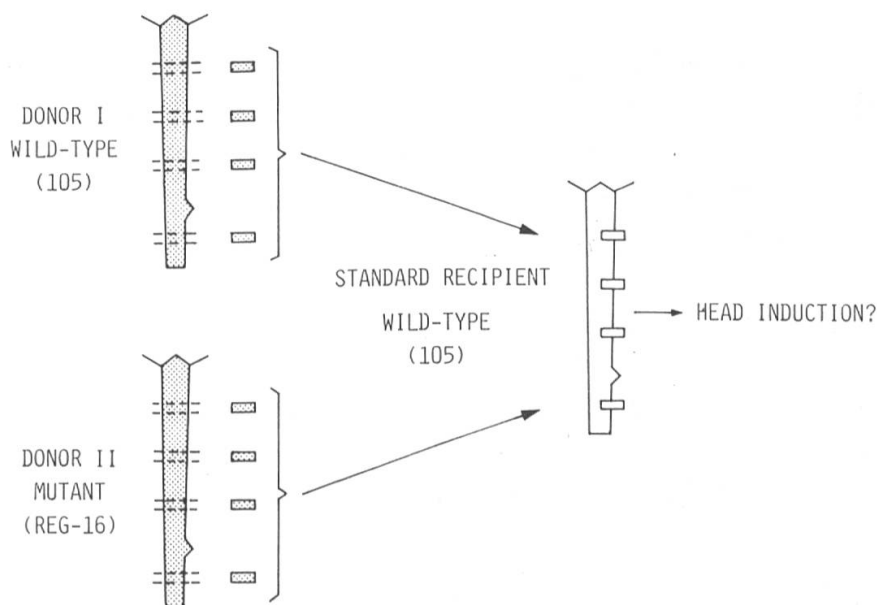

FIG. 1. — Transplantation procedure to compare the head-activation potentials of a mutant and a wild-type strain. Donor tissues were obtained from four positions of a mutant strain (e.g. reg-16) and a wild-type strain (105), and they were grafted to four positions on the wild-type strain (standard recipient).

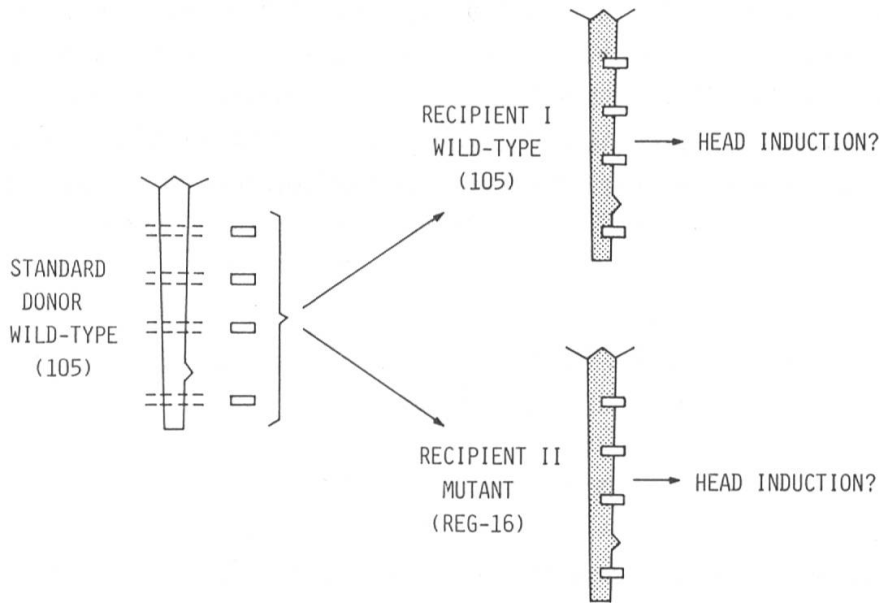

FIG. 2. — Transplantation procedure to compare the head-inhibition potentials of a mutant and a wild-type strain. Four positions of a mutant (e.g. reg-16) and the wild-type strain (105) were used as recipient sites, and the donor tissues obtained from four positions of the wild-type strain (standard donor) were grafted to them.

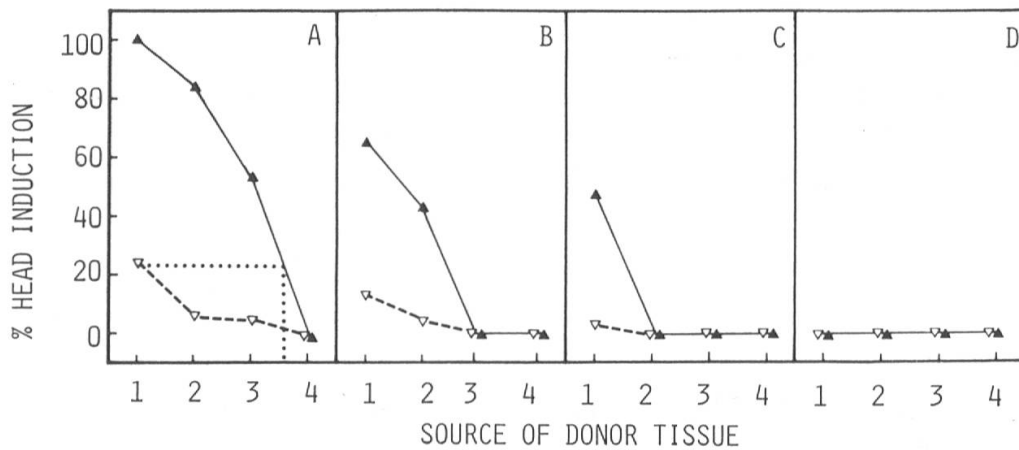

FIG. 3. — Comparison of the head-activation potential of 105 and reg-16. The abscissa represents the sources of the donor tissues obtained from 105 (closed triangles) and reg-16 (open triangles). The ordinate represents the percentages head induction which were observed when these donor tissues were grafted to position-4 (A), -3 (B), -2 (C), or -1 (D) of 105. The dotted lines in the figures indicate the 105 positions which have the same level of the head-activation potential as position-1 of reg-16. (The donor tissues obtained from these positions produce the same percentages of head induction.)

1970; Wolpert *et al.*, 1974; Sugiyama, 1982; MacWilliams, 1983a/b; Takano and Sugiyama, 1983; Achermann and Sugiyama, 1985).

These relationships were utilized to compare the relative levels of the morphogenetic potentials along the body axis of the wild-type standard strain (105) and three mutant strains: a regeneration deficient strain (reg-16), a slow budding strain (L4) and a multi-headed strain (mh-1). To compare the activation potential levels, the donor tissues were obtained from four positions of the wild-type strain and they were grafted to four positions on the standard wild type strain (105) (Figure 1). To compare the inhibition potentials, the four positions on the two strains were used as the recipient sites, and the donor tissues obtained from the four positions of 105 were grafted to them (Figure 2).

Figure 3 shows an example of comparing the head-activation potentials in reg-16 and 105 carried out by Achermann and Sugiyama (1985). It shows the percentages of head induction which occurred when the four donor tissues obtained from the two strains were grafted to the common recipient site at position-4 of 105. Three important features can be noted.

First, the donor tissues obtained from position-1, -2, -3 and -4 of 105 induced heads at 98%, 85%, 55% and 0%, respectively. As mentioned earlier, head induction is thought to be determined by the donor's head-activation and the recipients's head-inhibition potentials. Since the same recipient site is used in all the grafts, the results indicate that the head-activation potential is the highest in position-1 and the lowest in position-4, forming a "gradient" of the potential between these two positions in 105.

Second, the donor tissues obtained from position-1, -2, -3 and -4 of reg-16 induced heads at 24%, 6%, 5% and 0%, respectively. This indicates that a similar gradient of the head-activation potential also exists from position-1 to -4 in reg-16.

Third, the donor tissue obtained from position-1, -2 and -3 of reg-16 induced heads at much lower rates than the corresponding donor tissues from 105. This indicates that the levels of head-activation potential in these positions in reg-16 are significantly lower than those in 105. The donor tissues obtained from position-4 of 105 and reg-16 both induced no heads (Figure 3). This does not necessarily mean that the two strains have the same potential level at this position. This is because any donor tissue with the potential lower than a certain level will not induce a head.

The potential levels were similarly compared using other recipient sites on 105, and the results obtained are presented in Figures 3B-D. The same way of representations can be used for all results to determine the head-inhibition potential in reg-16 (Achermann and Sugiyama, 1985).

Although, this representation gives an idea about the head-activation and the head-inhibition potentials in each mutant strain, it can not be used to compare the potential levels between different mutant strains. A nice representation which allows such a comparison was first given by Takano and Sugiyama (1983). The results for

each graft combination separately shown in different figures were condensed and presented in one simple figure (Figure 4) by using the following procedure: strain 105 is adopted as the standard for the potentials and the potential at the four positions of other strains are all represented by the 105 positions which show the same head inducing capacities.

For example, the donor tissues from position-1 of reg-16 induced heads at 24% when grafted to position-4 of 105 (Figure 3A). The dotted lines drawn in the figure show that the hypothetical donor tissue obtained from position-3.5 of 105 would also induce the same percentage of heads when grafted to the same site. This indicates that position-1 of reg-16 and position-3.5 of 105 have the same level of the head-activation potential.

The same procedure, when applied to Figure 3B and C, shows that position-1 of reg-16 has the same head inducing capacity as position-2.7 and 2.0 of 105, respectively.

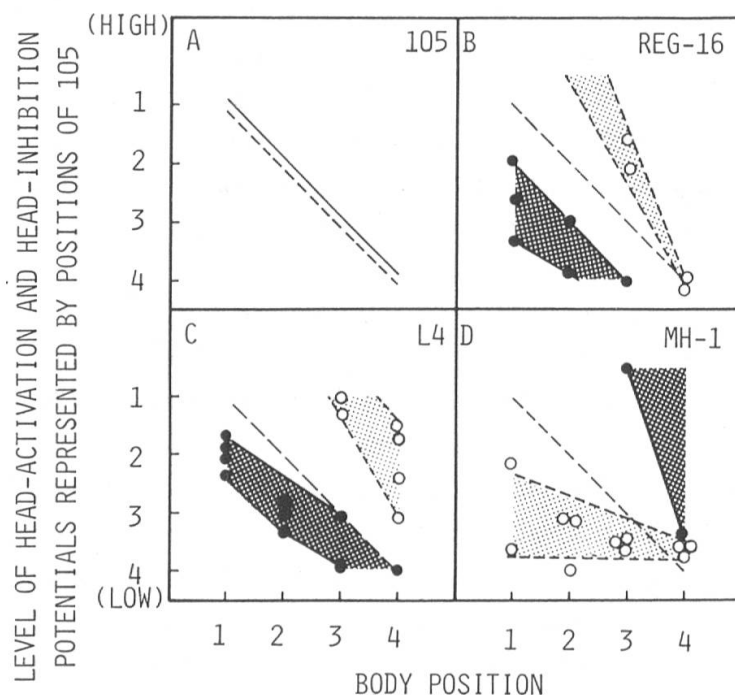

FIG. 4. — The levels of head-activation and head-inhibition potentials at four positions of 105 and three mutant strains. The abscissa represents the four axial positions along the body column of 105 and L4, and reg-16 and mh-1, respectively. The ordinate represents the levels of the head-activation and the head-inhibition potentials which are expressed using 105 as the standard of the potentials: in 105, position-1 has the highest level and positions-2, -3 and -4 have progressively lower levels of the head-activation and head-inhibition potentials. These levels are represented by 1 to 4 on the ordinate. The potential levels along the body column of 105 are shown by the straight lines. The potential levels along the body column of reg-16, L4 and mh-1 are represented by the 105 positions which have the same head inducing capacities. The levels of the head-activation potentials are shown by the dark line and the dark shaded areas, the levels of the head-inhibition potentials by the dotted line and the light shaded areas.

vely. These results indicate that the level of the head-activation potential at position-1 of reg-16 is roughly equal to the levels of the potential from position-2.0 to position-3.5 of 105.

The same procedure was also used to find the 105 positions which have the same head-activation potentials to the other three positions in reg-16, and the results obtained are shown in Figure 4B. It shows that the levels of the potential from position-1 to position-3 of reg-16 are significantly lower than the levels at the corresponding positions of 105. The level at position-4 of reg-16 can not be shown as already described.

The results to determine the head-inhibition potential in reg-16 were condensed and represented in the same way (Achermann and Sugiyama, 1985). Figure 4B shows that the level of the head-inhibition potential in reg-16 is higher than 105 from position-1 to position-3, but lower than in 105 in position-4.

The same experimental procedure was applied to determine the head-activation and the head-inhibition potentials in L4 (Takano and Sugiyama, 1983) and in mh-1 (Sugiyama, 1982). It was found that the polyp of L4 has a nearly normal or slightly lower head-activation potential but a significantly higher head-inhibition potential than 105 (Figure 4C). The polyp of mh-1, on the contrary, has a significantly higher-activation and a significantly lower head-inhibition potential than 105 (Figure 4D).

POTENTIAL ABNORMALITIES AND MORPHOGENETIC DEFECTS

The mutant strains, reg-16, L4 and mh-1, show highly abnormal morphogenetic potentials when compared to the standard wild-type strain (Figure 4). Moreover, the potential abnormalities are in good correlation to the morphogenetic defects in these strains (Table 1). For example, reg-16 has a greatly reduced head regenerative capacity, whereas the foot regeneration is normal (Sugiyama and Fujisawa, 1977). This strain has highly abnormal head-activation and head-inhibition potentials (Fig. 4B), but normal foot-activation and foot-inhibition potentials (Achermann and Sugiyama, 1985). These observations suggest that a direct correlation may exist between the potential abnormalities and the low head regeneration capacity. The same correlation between the potential abnormalities and the morphogenetic defects can be suggested for L4 and mf-1 (Sugiyama, 1982; Takano and Sugiyama, 1983). These results are, therefore, a strong support for the recent hydra pattern formation models (Gierer and Meinhardt, 1972; Wolpert *et al.*, 1974; MacWilliams, 1983), which assume that the head-activation and the head-inhibition potentials are directly involved in controlling hydra morphogenesis.

TAB. 1.

STRAIN	MORPHOGENETIC DEFECT	MORPHOGENETIC POTENTIALS	
		ACTIVATION	INHIBITION
REG-16	REDUCED HEAD REGENERATIVE CAPACITY	LOW	HIGH
L4	LARGE POLYP SIZE; LOW BUDDING RATE	SLIGHTLY LOWER	HIGH
MH-1	ADDITIONAL HEADS	HIGH	LOW

Morphogenetic defects and morphogenetic potential abnormalities in three mutant strains.

COMPARISON OF THE LEVELS OF MORPHOGENETIC POTENTIALS IN CHIMERIC STRAINS

Hydra tissue consists of three self proliferating cell lineages: the ectodermal epithelial cell lineage, the endodermal epithelial cell lineage and the interstitial cell lineage (which includes the interstitial stem cells and their differentiation products, nerve cells and nematocytes). By using the interstitial cell elimination and reintroduction method developed by Marcum and Campbell (1978) and the ectodermal-endodermal migration method of Wanek and Campbell (1982), it is possible to construct chimeric strains which consist of desired combinations of the three cell lineages derived from different parental strains. When two strains, a normal wild-type strain (105) and a mutant strain are used as parental strains, six types of chimeric strains can be constructed, each of which consists of two original cell lineages and one cell lineage of the opposite strain (Figure 5).

From a mutant strain, L4, and the wild type strain, 105, chimeric strains were constructed in the described way. Following this procedure, the morphogenetic potentials in each chimeric and the parental strains were determined using the same transplantation procedure as already described (Takano and Sugiyama, 1984).

The results of the transplantation experiments are summarized in Figure 6. For this representation the procedure previously described to compare the head-activation and the head-inhibition potentials in the wild type and the mutant strains (Figures 3 and 4) was used again. In this procedure, strain 105 was adopted as the standard of the potentials and the potential levels at the four positions of the chimeric strains were all represented by the positions of 105 that have the same levels of the potentials.

The potential levels of the parental strains are shown in Figure 6A/E. Since 105 was used as the standard of the potentials, its levels of the potentials were expressed

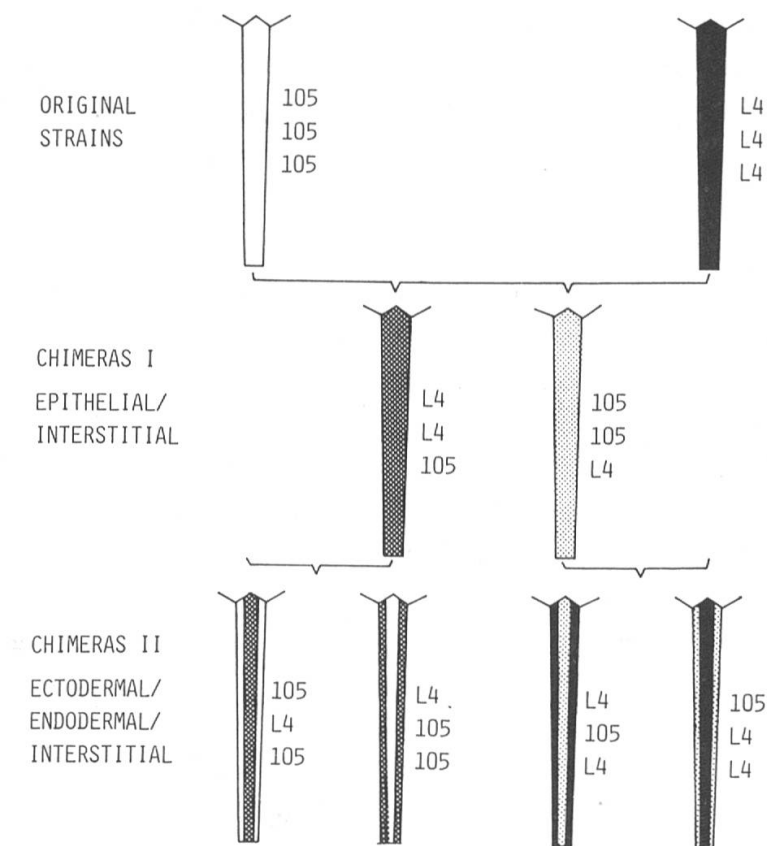

FIG. 5. — Experimental procedure to construct chimeric strains. From two parental strains, a wild-type and a mutant strain (e.g. L4) the three cell lineages, the ectodermal epithelial, the endodermal epithelial and the interstitial cell lineage, were separately substituted by a two step procedure. Chimeras I were constructed from the two parental strains by using the interstitial cell elimination and reintroduction method. Chimeras II were constructed from chimeras I and one of the parental strain by using the endodermal-ectodermal migration method. Each of the six chimeras consists of two cell lineages from one of the parental strain and one cell lineage of the opposite strain (e.g. 105/L4/105 = ect 105/end L4/int 105).

by the two straight lines (Figure 6A). The levels of the activation potential in L4 were slightly lower and its levels of inhibition potential were significantly higher than those of 105 (Figure 6E). The results in this analysis is therefore in good agreement with the previous results (Figure 4C).

The substitution of the interstitial cell lineage (chimeras 105/ 105/ L4 and L4/ L4/ 105) had no influence on the levels of the activation potential, but changes slightly the levels of the head-inhibition potential in both chimeric strains (Figure 6B/F), when compared to the parental strains (Figure 6A/E).

The substitution of the endodermal cell lineage (chimeras 105/ L4/ 105 and L4/ L4/ 105/ L4) changes the head-inhibition potentials in both chimeric strains (Figure 6C/G), but has no influence on the levels of the head-activation potential. It clearly appears that the inhibition potentials of the chimeras are similar to that in the endoderm-donor strains, whereas the activation potentials are similar to that in the endoderm/interstitial-cell donor strains.

In the chimeras where the ectodermal epithelial cell lineage is substituted (chimeras *L4/105/105* and *105/L4/L4*) the levels of the activation potential are changed in both strains, whereas the levels of the inhibition potential are not affected (Figure 6D/F).

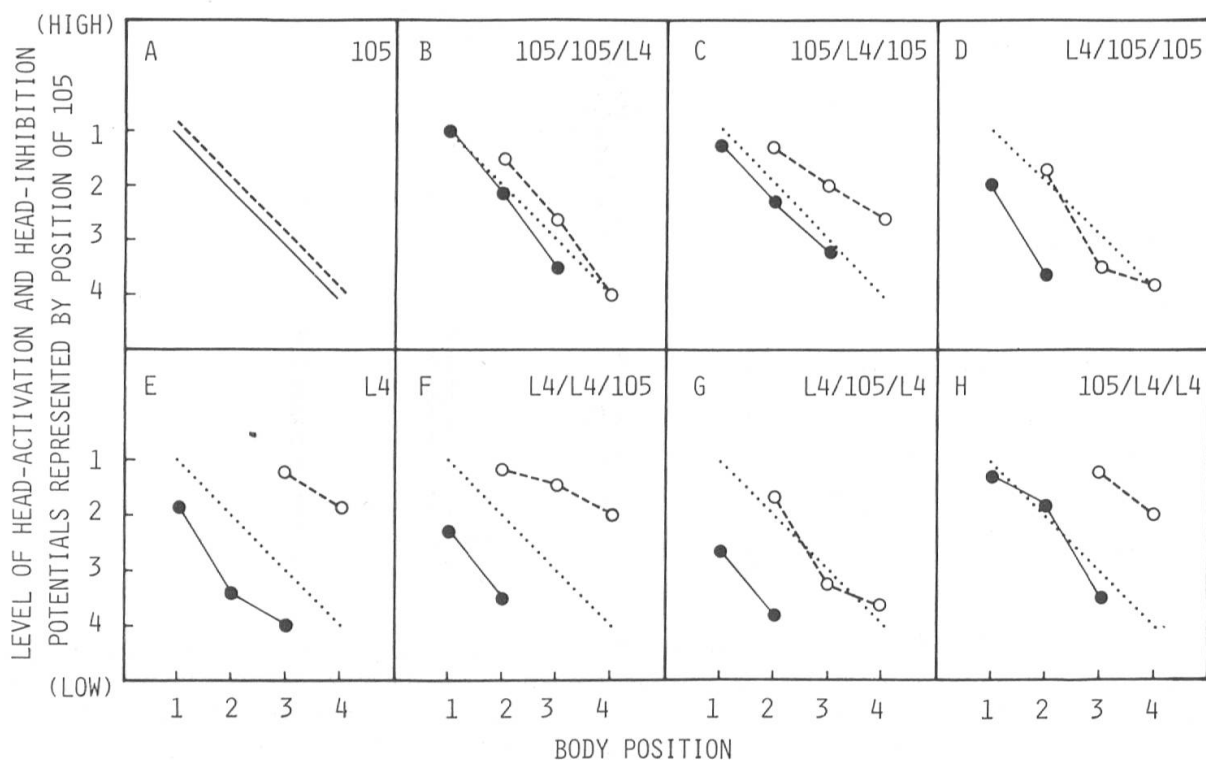

FIG. 6. — The levels of head-activation and head-inhibition potentials of 105, L4 and L4/105 chimeric strains. The abscissa represents the four axial positions along the body axis. The ordinate represents the level of head-activation (closed circles) and the head-inhibition (open circles) which are expressed using 105 as the standard of the potentials. The procedure to determine the potential levels is similar to that described in Figures 3 and 4. The origin of the cell lineages in each chimeric strain is indicated by the number of the parental strains for each cell lineage: 105/105/L4 = ect 105/end 105/int L4.

CELL LINEAGES AND MORPHOGENETIC POTENTIALS

From these observations strong evidences exist which suggest that the defect(s) responsible for the low head-activation potential of L4 resides in the ectodermal cell lineage of this strain, and that the defect(s) responsible for the high head-inhibition potential of reg-16 resides in its endodermal epithelial and interstitial cell lineages.

The cell lineages responsible for the altered potential levels have also been analyzed in the reg-16/105 chimeric strains (Wanek *et al.*, in preparation). Interestingly, the same cell lineages are responsible for the changes in both, L4 and reg-16. The defects responsible for the high head-inhibition potential of reg-16 and L4 are both

located in the endodermal epithelial and the interstitial cell lineages. In addition, strong evidence exists, that the defect for the low head-activation potential in *reg-16* is located in its ectodermal and its endodermal epithelial cell lineages. The same defect for *L4* is located in its ectodermal epithelial cell lineage.

It is, therefore, likely that the same lineages responsible for the potentials in the two mutant strains also determine them in the normal wild-type strain. A preliminary experiment to test this conclusion was done in the following way. From small tissue fragments, isolated from four positions of a wild-type donor animal, the ectodermal and the endodermal tissues were separated from each other by using the Procain-separation method by Smid and Tardent (1982). Following this separation, the ectodermal tissues were grafted into a standard recipient position, position-4, of a wild-type animal. Their ability to induce head structures was observed and compared to control grafts consisting of both the ectodermal and the endodermal tissue parts.

The results, summarized in Figure 7, show that ectodermal tissue alone has nearly the same head inducing ability as the control grafts. This indicates that the ectodermal tissue itself contains the most, if not the complete head-activation potential.

From these observations we can conclude that it is very probable that in general in hydra the ectodermal epithelial cell lineage play major roles in determining the activation potential levels, whereas the endodermal and the interstitial cell lineages play major roles in determining the inhibition potential levels. These observations

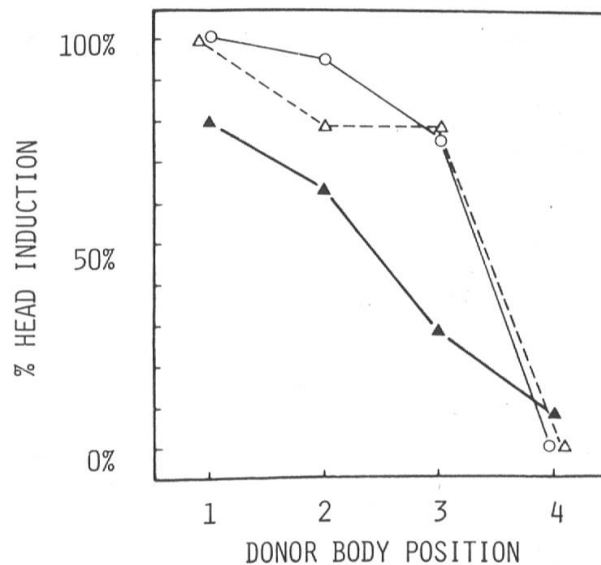

FIG. 7. — Head inducing ability of isolated ectodermal tissue. The abscissa represents the sources of the donor tissues obtained from 105. The ordinate represents the percentages of head induction by grafting these tissues into position-4 of 105: ectodermal tissue isolated by the Procain-treatment method (closed triangles), intact tissues consisting of ectoderm and endoderm (open circles), intact tissue treated with procain (open triangles). Each point represents at least 10 grafts.

open new possibilities to investigate the most interesting question how morphogenetic processes in hydra are controlled, and they may lead to a new understanding of pattern formation in this animal.

ACKNOWLEDGMENTS

This project was under the direction of Dr. T. Sugiyama and was mainly performed in his laboratory at the National Institute of Genetics, Mishima, Japan. The mutant strains were analyzed by T. Sugiyama (mh-1), J. Takano (L4) and J. A. (reg-16). The chimeric strains were constructed and analyzed by J. Takano (L4/105), N. Wanek, Ch. Nishimiya, T. Sugiyama, and J. A. (reg-16/105). One experiment was performed in the laboratory of Dr. P. Tardent, University of Zürich, Switzerland. The author is indebted to Dr. T. Sugiyama for critically reading the manuscript.

REFERENCES

- ACHERMANN, J. and T. SUGIYAMA (1985). Genetic analysis of developmental mechanisms in Hydra. X. Morphogenic potentials of a regeneration-deficient strain (reg-16). *Dev. Biol.* 107, 13-21.
- GIERER, A. and H. MEINHARDT (1972). A theory of biological pattern formation. *Kybernetik* 12, 30-39.
- MACWILLIAMS, H. K. (1982). Numerical simulations of hydra head regeneration using a proportion-regulation version of the Gierer-Meinhardt model. *J. Theor. Biol.* 99, 681-703.
- (1983a). Hydra transplantation phenomena and the mechanism of hydra head regeneration. I. Properties of the head inhibition. *Dev. Biol.* 96, 217-238.
- (1983b). Hydra transplantation phenomena and the mechanism of hydra head regeneration. II. Properties of the head activation. *Dev. Biol.* 96, 239-257.
- MACWILLIAMS, H. K., F. C. KAFATOS and W. H. BOSSERT (1970). The feedback inhibition of basal disk regeneration in hydra has a continuously variable intensity. *Dev. Biol.* 23, 380-398.
- MARCUM, B. A. and R. D. CAMPBELL (1978). Developmental roles of epithelial and interstitial cell lineages in hydra: analysis of chimeras. *J. Cell Sci.* 32, 233-247.
- MEINHARDT, H. and A. GIERER (1974). Application of a theory of biological pattern formation based on lateral inhibition. *J. Cell Sci.* 15, 321-346.
- SMID, I. and P. TARDENT (1982). The influences of ecto- and endoderm in determining the axial polarity in *Hydra attenuata* Pall (Cnidaria, Hydrozoa). *Wilhelm Roux's Arch.* 191, 64-67.
- SUGIYAMA, T. (1982). Roles of head-activation and head-inhibition potentials in pattern formation in hydra: Analysis of a multihead mutant strain. *Amer. Zool.* 22, 27-34.
- SUGIYAMA, T. and T. FUJISAWA (1977a). Genetic analysis of developmental mechanisms in hydra. I. Sexual reproduction of *Hydra magnipapillata* and isolation of mutants. *Dev. Growth Differ.* 19, 187-200.
- SUGIYAMA, T. and T. FUJISAWA (1977b). Genetic analysis of developmental mechanism in hydra. III. Characterization of a regeneration deficient strain. *J. Embryol. Exp. Morphol.* 42, 65-77.
- SUGIYAMA, T. and T. FUJISAWA (1978). Genetic analysis of developmental mechanisms in hydra. V. Cell lineages and development of chimeric hydra. *J. Cell Sci.* 32, 215-232.
- TAKANO, J. and T. SUGIYAMA (1983). Genetic analysis of developmental mechanisms in hydra. VIII. Head-activation and head-inhibition potentials of a slow-budding strain (L4). *J. Embryol. Exp. Morph.* 78, 141-168.

- TAKANO, J. and T. SUGIYAMA (1984). Genetic analysis of developmental mechanisms in hydra. XII. Analysis of chimeric hydra produced from a normal and a slow budding strain (L4). *J. Embryol. Exp. Morph.* 80, 155-173.
- TREMBLEY, A. (1977). *Mémoires pour servir à l'histoire d'un genre de polype d'eau douce*. A. Leide, chez J. et H. VERBECK.
- WANEK, N. and R. D. CAMPBELL (1982). Roles of ectodermal and endodermal epithelial cells in hydra morphogenesis: Construction of chimeric strains. *J. Exp. Zool.* 221, 37-47.
- WANEK, N., C. NISHIMIYA, J. ACHERMANN and T. SUGIYAMA (1985). *Genetic analysis of developmental mechanisms in hydra*. XI. Identification of the cell lineages responsible for the altered developmental potentials in a regeneration-deficient mutant strain, reg-16. In preparation.
- WEBSTER, G. (1966). Studies on pattern regulation in hydra. II. Factors controlling hypostome formation. *J. Embryol. Exp. Morph.* 16, 105-122.
- WEBSTER, G. and L. WOLPERT (1966). Studies on pattern regulation in hydra. I. Regional differences in time required for hypostome determination. *J. Embryol. Exp. Morph.* 16, 91-104.
- WOLPERT, L., A. HORNBRUCH and M.R.B. CLARKE (1974). Positional information and positional signaling in hydra. *Amer. Zool.* 14, 647-663.

