

Zeitschrift: IABSE structures = Constructions AIPC = IVBH Bauwerke
Band: 4 (1980)
Heft: C-13: Sports halls and stadia

Artikel: Swimming-Pool complex in Split (Yugoslavia)
Autor: Martinovic, I. / Peranic, S. / Pintaric, N.
DOI: <https://doi.org/10.5169/seals-16548>

Nutzungsbedingungen

Die ETH-Bibliothek ist die Anbieterin der digitalisierten Zeitschriften. Sie besitzt keine Urheberrechte an den Zeitschriften und ist nicht verantwortlich für deren Inhalte. Die Rechte liegen in der Regel bei den Herausgebern beziehungsweise den externen Rechteinhabern. [Siehe Rechtliche Hinweise.](#)

Conditions d'utilisation

L'ETH Library est le fournisseur des revues numérisées. Elle ne détient aucun droit d'auteur sur les revues et n'est pas responsable de leur contenu. En règle générale, les droits sont détenus par les éditeurs ou les détenteurs de droits externes. [Voir Informations légales.](#)

Terms of use

The ETH Library is the provider of the digitised journals. It does not own any copyrights to the journals and is not responsible for their content. The rights usually lie with the publishers or the external rights holders. [See Legal notice.](#)

Download PDF: 16.03.2025

ETH-Bibliothek Zürich, E-Periodica, <https://www.e-periodica.ch>

16. Swimming-Pool complex in Split (Yugoslavia)

Owner: Municipal Assembly, Split

Architect Designer: KRIVAJA – Industrial Engineering, Belgrad

Engineering: Institut za gradjevinarstvo pri gradjevinsko fakultetu, Belgrad

Contractor: Hidroelektra Co., Zagreb and its Subcontractors

Introduction

In the vicinity of the City Stadium, on the northern side, a new Swimming-Center had been built for the VIIIth Mediterranean Games held in September 1979. This beautiful complex can host the entire swimming, diving and waterpolo competitions. (Fig. 1).

The swimming and waterpolo Olympic pool is of a 2180 seating capacity. (Fig. 2). Under the same roof, there is a pool measuring 33.33 m × 25 m with a 720 seating capacity, and a third pool measuring 25 m × 8 m. On an outdoor platform, there is a pool for diving competitions measuring 33.33 m × 25 m.

The Scope of Construction

The swimming hall structure consists of two so-called S-beams, which are connected by four beams about 64 m long, three of them of prestressed concrete with BBRV cables. Two of these prestressed beams support the stands of the Olympic pool.

A special impression is achieved by the suspended roof structure of an unusually great span, covering a rectangular area of 77 m × 64 m (Fig. 3).

This roof consists of double curved network:

- 39 longitudinal S-shaped cables of 8 wires dia 7 mm, approx. 87 m long, supported on two transversal concrete beams and
- 47 transversal hyperbolic cables (20 positive curved, 1 horizontal and 26 negative curved) of 8 to 32 wires dia 7 mm, approx. 65 m long, supported on two concrete S-beams.

Two S-beams as well as two transversal ones had been carried out as box type girders serving as anchoring of all roof cables (Fig. 4).

The BBRV cables had been chosen because of simple cable installations and anchorings, as well as stressing and rectification of the network. Using the special Stahlton Flex ducts, wires and anchor elements, the cables had been assembled in the cable manufacturing plant and then acting as cable units shipped on reels to the building site. Unit by unit, cables were unrolled and placed into their positions in the network by the use of cranes.

The 1833 crossing points were fixed in accurate positions by specially made stainless steel-crosses (Fig. 5).

By pretensioning the 26 negative curved transverse cables of 8 wires dia 7 mm in several stages according to a predetermined program, the roof obtains the definitive shape required. Subsequently the forces, of

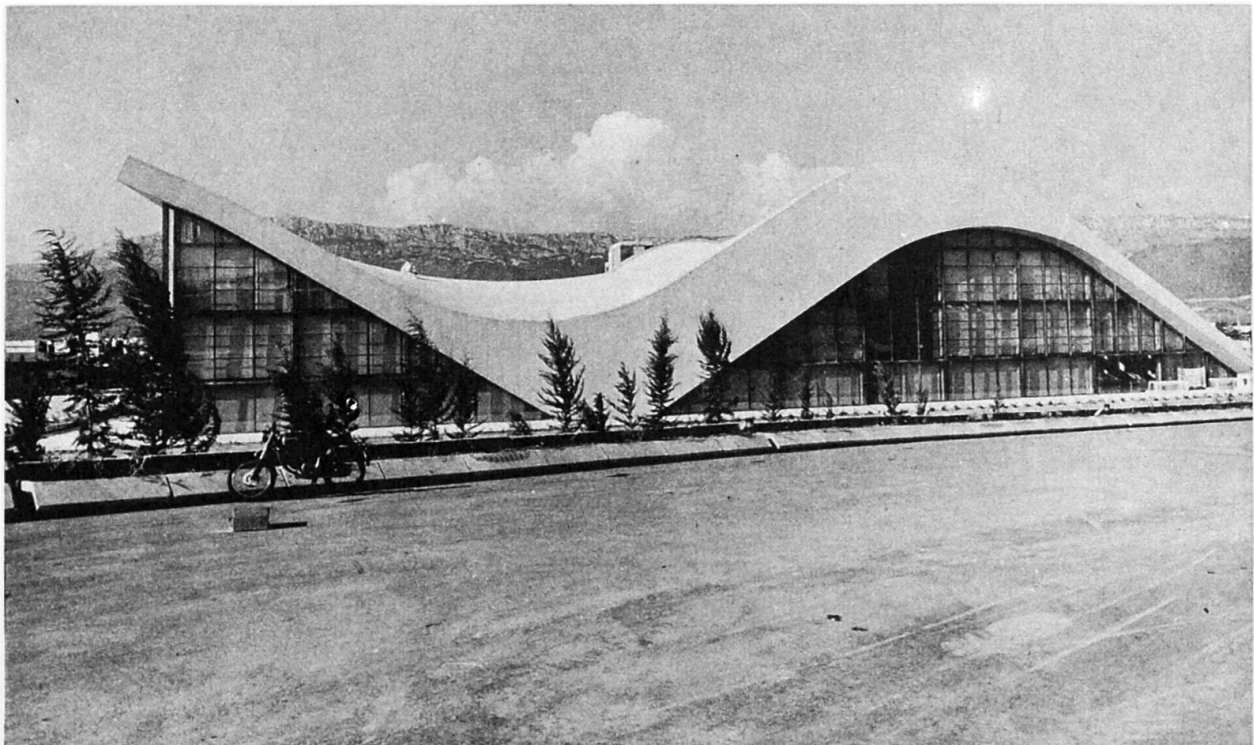

Fig. 1.

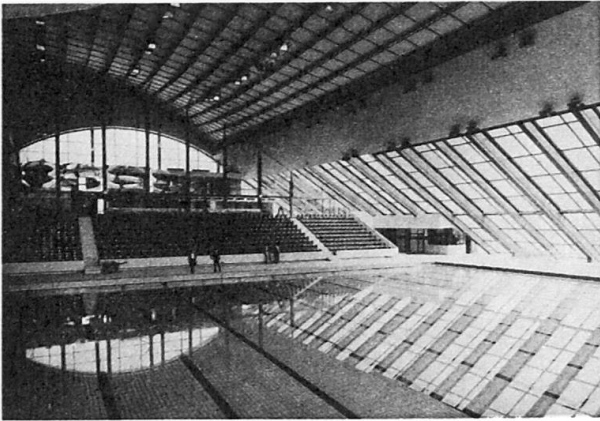

Fig. 2.

the longitudinal cables as well as the negative curved ones which had both been manufactured in lengths calculated in advance, were checked. The network thus formed gives the appearance of a grid system, rigid enough to resist asymmetric loading.

In this cable-suspended roof, the system of cables carries the roof load directly, having therefore primarily a structural function. The cable system also served as the falsework during the erection of the cladding.

The prestressing works and cable-suspended roof structure were completely performed by Geotehnika Co., Zagreb in consultation with Stahlton A.G., Zurich.

The quantities of materials being built in this structure are stated here-under:

- Concrete	25,000 m ³
- Reinforcement	3,852 t
- High tensile steel wire dia 7 mm for the prestressed concrete girders	84 t
- High tensile steel wire dia 7 mm for cable-suspended roof	21 t
- Cladding	4,928 m ²

Remarkable aspects

- The special usage of BBRV cables for the cable-suspended roof.
- The record erection time was achieved in spite of some difficulties during construction.

The City Stadium and the Swimming-Pool Complex combine to form an architectural unit, which has become a sports and recreation zone of Split.

(I. Martinovic, S. Peranic, N. Pintaric)

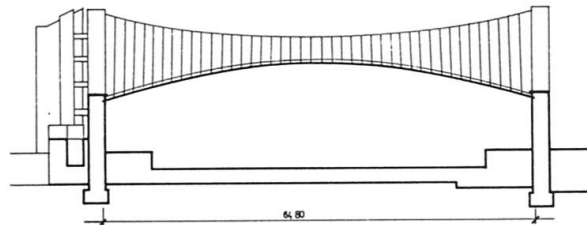
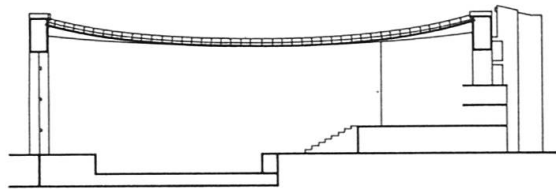

Fig. 4.

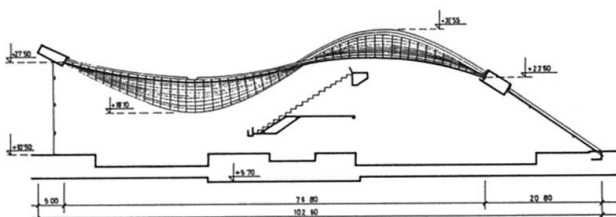
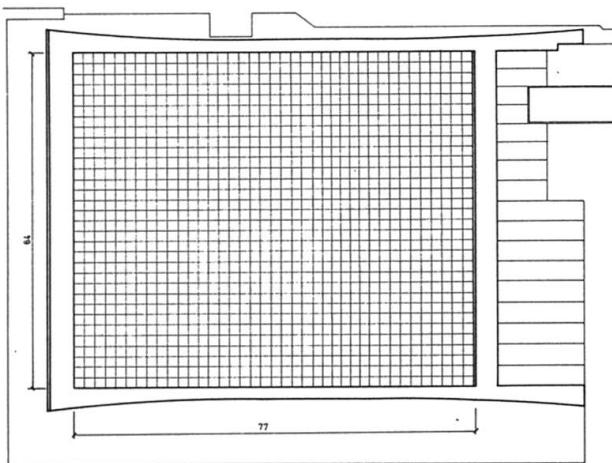

Fig. 3.

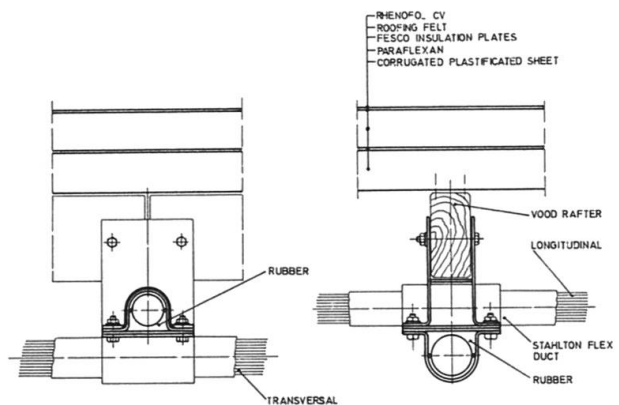

Fig. 5.