

Zeitschrift: IABSE proceedings = Mémoires AIPC = IVBH Abhandlungen
Band: 8 (1984)
Heft: P-75: Dynamic load testing of highway bridges

Artikel: Dynamic load testing of highway bridges
Autor: Cantieni, Reto
DOI: <https://doi.org/10.5169/seals-38337>

Nutzungsbedingungen

Die ETH-Bibliothek ist die Anbieterin der digitalisierten Zeitschriften. Sie besitzt keine Urheberrechte an den Zeitschriften und ist nicht verantwortlich für deren Inhalte. Die Rechte liegen in der Regel bei den Herausgebern beziehungsweise den externen Rechteinhabern. [Siehe Rechtliche Hinweise.](#)

Conditions d'utilisation

L'ETH Library est le fournisseur des revues numérisées. Elle ne détient aucun droit d'auteur sur les revues et n'est pas responsable de leur contenu. En règle générale, les droits sont détenus par les éditeurs ou les détenteurs de droits externes. [Voir Informations légales.](#)

Terms of use

The ETH Library is the provider of the digitised journals. It does not own any copyrights to the journals and is not responsible for their content. The rights usually lie with the publishers or the external rights holders. [See Legal notice.](#)

Download PDF: 17.03.2025

ETH-Bibliothek Zürich, E-Periodica, <https://www.e-periodica.ch>

Dynamic Load Testing of Highway Bridges

Essais dynamiques sur des ponts routiers

Dynamische Belastungsversuche an Strassenbrücken

Reto CANTIENI

Civil Engineer
Swiss Fed. Lab. Mat. Testing and Res.
Dübendorf, Switzerland



Reto Cantieni, born 1945, obtained his civil engineering degree at the Swiss Federal Institute of Technology (ETH), Zürich. After being employed for three years in a design firm he joined the Institute of Structural Engineering at ETH Zürich as an assistant. Since 1974 he has worked at EMPA, involved mainly in structural dynamics problems.

SUMMARY

Following a brief historical review, dynamic load tests on highway bridges as performed in standardized form for many years at EMPA (Swiss Federal Laboratories for Materials Testing and Research) are described. The most important boundary conditions and results of such tests, carried out on 226 bridges are then presented and discussed. Developments in recent years have largely involved the introduction of digital signal processing equipment. Based upon a practical example, the possibilities offered by analyzing measurement signals in the frequency domain are presented.

RÉSUMÉ

Après un bref aperçu historique, l'auteur décrit les essais de charge dynamique sur des ponts routiers tel qu'ils sont réalisés sous une forme standardisée depuis plusieurs années par l'EMPA (Laboratoire fédéral d'essais des matériaux et institut de recherches). Les conditions aux limites les plus importantes ainsi que les résultats d'essais effectués sur 226 ponts sont présentés et discutés. Le développement dans ce secteur au cours des dernières années a surtout été marqué par l'introduction du traitement digital des signaux de mesure. Les possibilités qu'offre l'analyse de tels signaux dans le domaine des fréquences sont exposées sur la base d'un exemple pratique.

ZUSAMMENFASSUNG

Nach einem kurzen geschichtlichen Rückblick werden die dynamischen Belastungsversuche an Strassenbrücken, wie sie von der EMPA (Eidg. Materialprüfungsanstalt) seit vielen Jahren in standardisierter Form durchgeführt werden, beschrieben. Die wichtigsten Randbedingungen und Resultate solcher an 226 Brücken durchgeführter Versuche werden anschliessend dargestellt und diskutiert. Die Entwicklung der letzten Jahre wurde vor allem durch die Einführung der digitalen Verarbeitung von Messsignalen geprägt. An einem praktischen Beispiel werden die Möglichkeiten erläutert, die die Analyse solcher Signale im Frequenzbereich bietet.



1. INTRODUCTION

It is now ten years since it was decided at the Section Concrete Structures of the Swiss Federal Laboratories for Materials Testing and Research (EMPA) to take a closer look into the dynamic behavior of highway bridges under traffic loading. The reason for initiating research activities in this field is obvious: Although a considerable number of dynamic load tests on highway bridges had been performed by this Section in the past, it was always felt that the results of these tests could not be optimally interpreted. Since investigation of the problem with analytical or numerical methods did not seem to promise results having the necessary general validity and simplicity, the most straightforward way of improving knowledge was chosen, namely trying to gain as much information from previous experience as possible.

Looking back to the roots of EMPA's activities in dynamic field testing, it was noted that the first test was probably performed in 1922 on the Kettenbrücke in Aarau [1]. This iron chain suspension bridge (Fig. 1) was constructed in 1850, tested by EMPA in 1922, 1934 and 1945 and finally replaced by a three-span reinforced concrete structure in 1950. From the 1922 tests, Figure 2 shows two deflection traces gathered with a mechanical vibration recorder (vibrograph) in one of the quarter points of the bridge.

Since the equipment necessary for measuring and recording dynamic signals, above all the vibrograph, had been developed at the end of the last century, EMPA probably entered the field of dynamic bridge testing even earlier. However, this assumption cannot be confirmed since no test reports or publications remain.

It is due to M. Roš who held a leading position at EMPA from 1924 until 1949 that we are very well documented on tests performed in this next period. Aside from Reference [1] which covers tests on steel structures performed between 1922 and 1945, his legendary EMPA-Report No. 99 [2] has to be mentioned. This report contains the description and results of load tests undertaken between 1923 and 1947 on 46 reinforced concrete bridges including the most famous structures of Robert Maillart. Trying to draw generally valid conclusions concerning the dynamic behavior of highway bridges, Roš had to face the fact that the number of comparable tests was too small [2]. Above all, the scatter of the loading parameters was considerable: Single or multiple horse-drawn vehicles and single or multiple trucks of various types had been used as test vehicles.



Fig. 1 The Kettenbrücke in Aarau, here during the 1945 static tests. Photograph from [1].

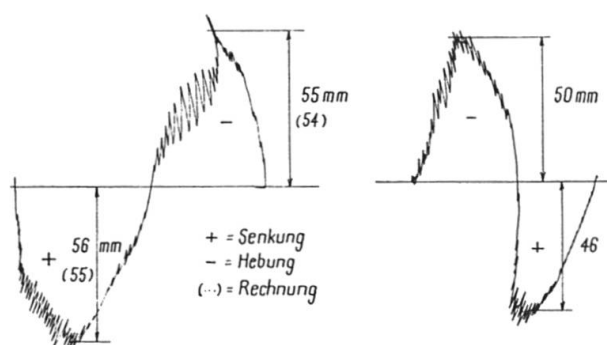

Fig. 2 Kettenbrücke Aarau (one suspended 97.5 m span); dynamic load tests of 1922. Deflection traces measured and recorded with a vibrograph (from [1]). Left: Passage of 70 riders with a total mass of 42 t at a normal pace. Right: Passage, in the reverse direction, of 12 riders with a total mass of 7.2 t at a trot.

The important and fortunate decision to standardize test procedures and data processing methods as far as possible was made by Voellmy and Rösli in the 1950's. For example, practically all dynamic tests on highway bridges were performed thereafter with single two-axle trucks as test vehicles. Some of the reports on tests on 20 prestressed concrete bridges Rösli described in 1960 [3] are still available. They yield the earliest of the data presented in the following sections of this report.

In the years 1958 to 1981, the Section Concrete Structures of EMPA performed static and standardized dynamic load tests on 226 slab and beam-type highway bridges. Test procedures and techniques of data acquisition and processing are described in Section 2. Section 3 gives the summarized results of these tests and some conclusions which could be drawn. Keeping pace with the rapid development of electronics, EMPA methods of data acquisition and processing were continually updated in the last years. The most important steps of this evolution are presented in the final section, together with an example illustrating the current methods.

2. LOAD TESTS AS PERFORMED BY EMPA SINCE 1958

2.1 Test Procedures

The bridges are tested dynamically through passages of a single, fully loaded, two-axle truck which is provided by the client. The gross weight of the vehicle usually lies near the legal limit of 160 kN (280 kN is in general the maximum legal gross weight limit in Switzerland for any type of vehicle).

The test vehicle is driven at constant speed, whenever possible along the longitudinal bridge axis and always in the same direction (Fig. 3). The tests are begun with a vehicle speed of $v = 5$ km/h which is then increased after every passage in steps of $\Delta v = 5 \dots 10$ km/h up to the maximum achievable speed. The tests on the undisturbed pavement are repeated with a plank placed on the roadway in the main measurement cross section (approx. dimensions 50 mm x 300 mm x 5,000 mm).



Fig. 3 A two-axle test vehicle before passing over a contact threshold (speed measurement) and over a plank.



Fig. 4 With the help of a test wheel, the speed can be accurately measured and controlled during the passage.



In order to further reduce variations in the load parameters, several improvements have been introduced in recent years. Unfortunately, EMPA has not been able to obtain its own test vehicle. However, it is now possible to make use of the same Army vehicle for all the tests. Pay load, tires and tire pressure are always the same, so it can be assumed that the dynamic properties of the vehicle remain approximately constant. In addition, the driving lane is established with rubber cones or paint (Fig. 3) and the vehicle speed is controlled with a special test wheel (Fig. 4). Thus it is possible to maintain constant speed within ± 0.5 km/h from $v = 2$ km/h up to $v = 100$ km/h.

2.2 Data Acquisition and Recording

Deflection is measured whenever possible at the characteristic point of the bridge which is normally at the mid-point of the maximum span (main measurement cross section). In many cases deflection is measured at additional points of the super-structure. The measurement basis is provided by an invar wire stretched between the measurement point at the structure and a fixed reference point under the bridge. In about 1964 the vibrographs which registered the deflection signal on a rotating cylinder (Fig. 5) were replaced by electronic measurement set-ups. These usually consist of an inductive displacement transducer (Fig. 6), a signal amplifier and an ink recorder.

Since stretching of a wire between the measurement and reference points may not be practicable, it is not always possible to measure the deflection in the structure's characteristic point. In cases where bridges for example cross rivers, the main measurement cross section has to be shifted to a side span or strain measurements have to be substituted at the characteristic point.

Comparative tests were performed in 1979 where a laser-based system was utilized for additional deflection measurements [4]. The laser system proved to be a valuable substitute for the wire-based set-up if a certain susceptibility to weather conditions is taken into account.

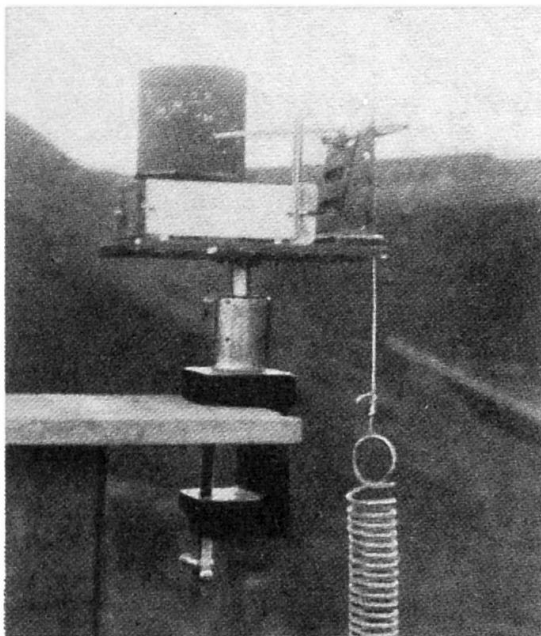

Fig. 5 Mechanical vibration recorder (vibrograph), System Stoppani. Photograph from [1].

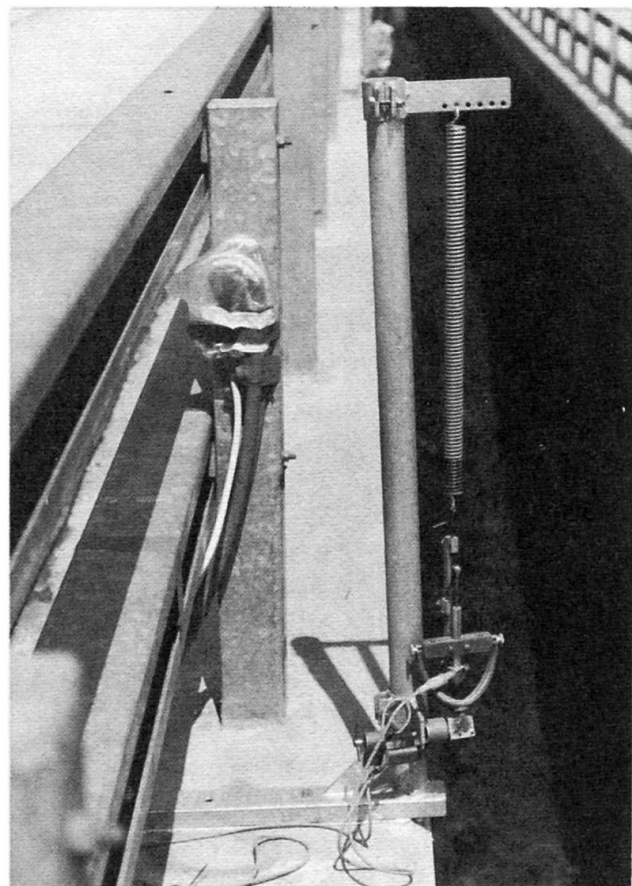

Fig. 6 Inductive displacement transducer, measurement range ± 20 mm, mounted at a bridge parapet.

2.3 Data Processing

From the dynamic bridge response, registered on paper strips, the following information can usually be obtained (Fig. 7):

- The frequency of one or more modes of the bridge,
- damping of the natural vibration dominant in free decay, and
- the dynamic increment of one or more measurement signals as a function of the vehicle speed.

As a by-product, the spring constant k of the bridge is obtained from the ratio of static load to deflection. This is quite significant for evaluating the overall stiffness of a structure.

The natural frequency and associated damping can be determined by manual signal analysis in the time domain only if the bridge vibrations decay simply harmonically after the passage of the vehicle. If an accurate time measure has been recorded along with the signal, the natural frequency can be established by counting the number of periods in a given portion of the decay process:

$$f = \frac{n}{t} \quad [\text{Hz}] \quad \begin{array}{l} n = \text{number of periods} \\ t = \text{corresponding time interval in seconds} \end{array}$$

The damping, for example the logarithmic decrement δ , can be determined from the same time interval. This requires measurement of the magnitude of the first and last amplitudes having the same phase:

$$\delta = \frac{1}{n} \ln \frac{A_0}{A_n} \quad \begin{array}{l} n = \text{number of periods} \\ n+1 = \text{number of amplitudes included between } A_0 \text{ and } A_n \\ \ln = \text{natural logarithm} \end{array}$$

The percentage of critical damping ρ is given by:

$$\rho = \frac{\delta}{2\pi} \cdot 100 \quad [\%].$$

The dynamic increment as determined from the EMPA tests is defined as

$$\phi = \frac{A_{\text{dyn}} - A_{\text{stat}}}{A_{\text{stat}}} \cdot 100 \quad [\%]$$

where A_{dyn} is the peak value of the bridge deflection measured during a passage of the test vehicle and A_{stat} is the peak value of deflection observed under static loading with the same vehicle. (ϕ -values determined from strain measurements are considered as non-standard.)

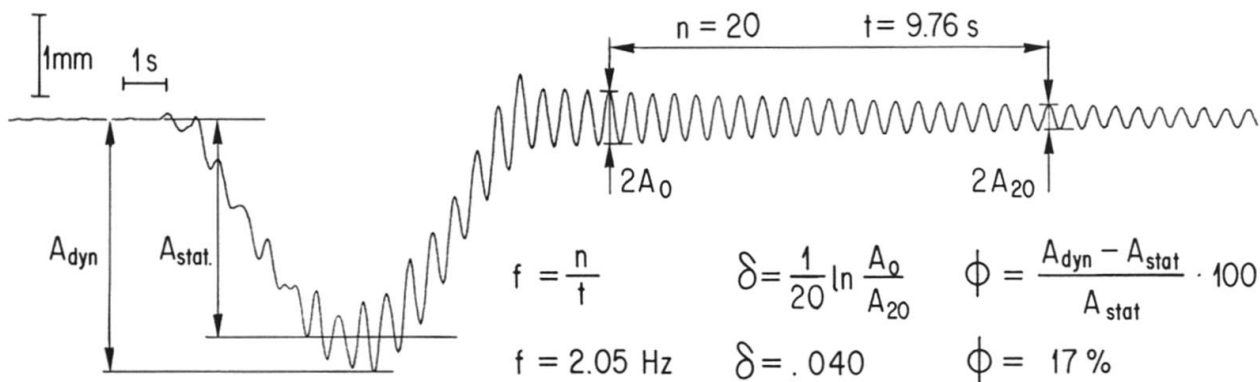

Fig. 7 Deflection of the mid-point of the Ponte di Campagna Nova (one 45 m-span) under the passage of a 160 kN vehicle with $v = 25$ km/h on the undisturbed pavement. f = fundamental frequency, δ = logarithmic decrement, ϕ = dynamic increment.



While the read-out of A_{dyn} from a paper strip can be performed in a straightforward manner, the determination of A_{stat} may be problematic. Two basically different methods have been used. In earlier years, A_{stat} was estimated for every passage from the same dynamic trace as the corresponding A_{dyn} . With increasing dynamic response of a bridge, the quality of this estimation for A_{stat} decreases. Therefore, in recent years A_{stat} has been determined from the traces of three very slow passages (crawl tests) and the value thus obtained is subsequently used in the evaluation of all the passages. Comparative tests in 1976 have shown that both methods yield the same value for A_{stat} if the driving lane is well marked and accurately maintained by the driver.

The determination of the dynamic increment ϕ is beset with an additional problem. Aside from all the known quantities such as vehicle properties and speed, pavement roughness and bridge properties, the position of the measurement point in the cross section of the bridge was found, under certain circumstances, to exert a significant influence on the calculated value of the dynamic increment. This comes about because the deflection distribution over a bridge cross section under static and dynamic loading is generally not identical. Experience shows that on the one hand, the deflection (A_{stat}) of a statically loaded beam-type bridge will always vary more or less strongly over its cross section, depending on the shape and stiffness of the section. On the other hand, the vertical motional amplitudes (responsible for A_{dyn}) of the same bridge under dynamic loading will remain constant over the cross section, as long as the bridge response consists solely of longitudinal bending modes. The dynamic increment ϕ as a relation between A_{dyn} and A_{stat} will therefore depend on the exact location of the measurement point in the bridge cross section. This dependency is almost negligible for bridges with stiff box-shaped cross sections but may invalidate results gathered from bridges with wide and flexible I-beam cross sections.

Measured dynamic increments can therefore be reliably interpreted only if A_{stat} represents the largest possible value that can be obtained in a given cross section, with a given vehicle. This can be assumed to be the case if the measurement point lies within the direct influence region of the vehicle, i.e. if $\alpha \leq 1.0$ (Fig. 8).

3. TESTS ON 226 HIGHWAY BRIDGES (1958 - 1981)

In the years 1958 to 1981 the Section Concrete Structures of EMPA performed load tests on 356 bridges. In the present context, the standardized dynamic part of 226 combined tests on beam and slab-type highway bridges is of interest. (The remaining 130 tests concerned combined static and dynamic tests on arched highway bridges, footbridges and bridges on private railway lines and purely static tests.)

Conditions and results of these tests were stored in a computer data bank containing a maximum of 40 parameters per test. This data collection was subsequently analyzed. The results are presented in the next several paragraphs in rather condensed form. More detailed information is given in [5].

Although 226 tests were considered, the number of measurement values actually taken into account was less for some parameters: It was not always possible to meet all the requirements of a standard test and the value of concern was sometimes unknown or could not be determined from the recorded signals. Special requirements to be met (which led to a further decrease of values to be considered) are mentioned in the corresponding paragraphs.

3.1 Test Conditions

The two-axle trucks utilized in 215 tests can be characterized by the parameters "gross weight" and "axle spacing". The gross weight ranged between 110 kN and

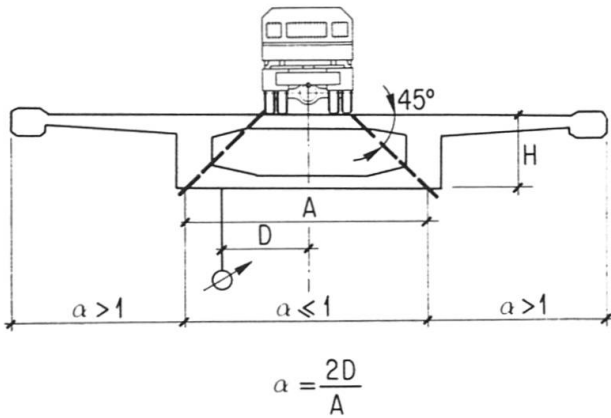

Fig. 8 Definition of the coefficient α describing the location of the measurement point in the bridge cross section relative to the direct influence region of the vehicle.

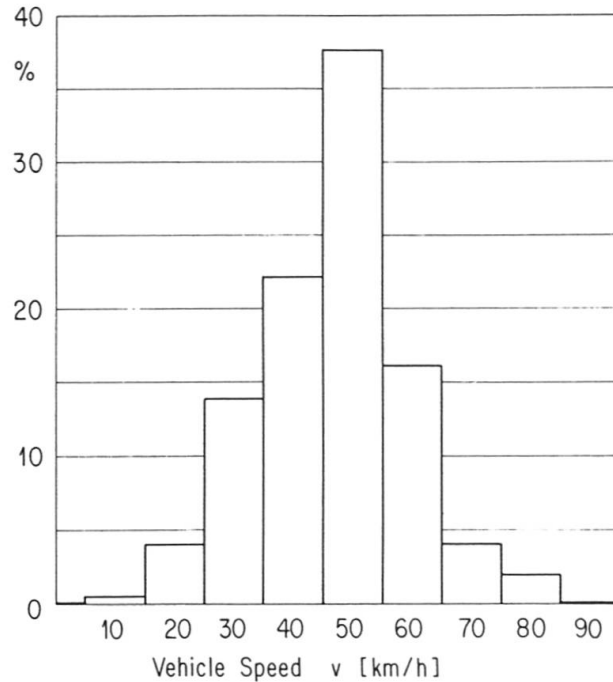

Fig. 9 Maximum attained vehicle speed in the tests. 224 values; min.: 10 km/h, mean: 47 km/h, max.: 80 km/h.

193 kN with a mean of 158 kN. Roughly 50 % of the values were in the class 160 ± 5 kN. The extreme values of axle spacing are 3.4 m and 6.0 m and the mean value 4.4 m; more than 70 % of the vehicles had an axle spacing in the range of 4.5 ± 0.12 m.

In 197 tests, the driving axis was identical with the longitudinal axis of the bridge. Figure 9 shows the distribution of the maximum attained vehicle speed for the respective tests. It is observed that the speed was frequently limited to 30...40 km/h.

The surface condition of the bridge deck is mentioned in 158 test reports. Half of the pavements were classified as being rather smooth respectively half were medium to poor.

Of the 226 bridges, 205 are prestressed concrete, 5 reinforced concrete, 14 composite steel/concrete and 2 prestressed lightweight concrete structures. The number of spans varies between 1 and 42 with an average of 4 and a value of peak occurrence of 3 (48 %). The most common structural systems are the continuous beam over more than one span (72 %) and the simply supported one-span beam (12 %). Total lengths and lengths of the maximum span can be characterized as follows:

| | <u>Total Length</u> | <u>Maximum Span</u> |
|-----------|----------------------|---------------------|
| minimum | 13.0 m | 11.0 m |
| maximum | 3,147.5 m | 118.8 m |
| mean | 155.9 m | 39.5 m |
| peak occ. | 60 ± 10 m (20 %) | 30 ± 5 m (30 %) |

109 of the bridges tested are straight and without skew, 97 are skewed or curved, 20 are both skewed and curved. Half of the bridges have a box-shaped cross section, 26 % a multi-beam deck and 24 % a solid or hollow-core slab cross section. The cross-sectional width varies between 4.3 m and 30.4 m with a mean value of 12.9 m and a class of maximum occurrence of 10 ± 1 m (35 %).



3.2 Test Results

3.2.1 Spring Constants

The results presented in Figure 10 stem from 187 tests in which the deflection was measured on the largest span and the spring constant k could be calculated from the data from either the static or dynamic tests.

3.2.2 Natural Frequencies

Figure 11 shows the distribution of fundamental frequencies measured on 224 bridges. The result of an attempt to establish a relation $f = g(L)$ between the fundamental frequency f of a bridge and its maximum span L is presented in Figure 12. The scatter of the measurement values around a curve determined through nonlinear regression is considerable. This is not surprising in view of the large variations in geometry and stiffness of the bridges tested. In order to achieve a smaller scatter, the following limitations were introduced:

- Elimination of the values of cantilevered structures,
- limitation of the horizontal radius of curvature of the longitudinal bridge axis: $R \geq 900$ m,
- limitation of the skew: $\gamma \leq 15$ deg.,
- limitation of the spring constant k : $70 \text{ kN/mm} \leq k \leq 270 \text{ kN/mm}$,
- elimination of results that were not obtained from measurements on the maximum span.

The regression function calculated from the remaining 100 values is almost identical to the function indicated in Figure 12 but the scatter has diminished from $\sigma_f = \pm 0.81$ Hz to $\sigma_f = \pm 0.61$ Hz:

$$f = 90.6 \cdot L^{-0.923} = g^*(L).$$

As will be shown later, the dynamic increment will probably be defined in a future Swiss Code on Bridge Loading as a function of the bridge's fundamental frequency. Therefore, the above mentioned equation to simply estimate this frequency may be of some practical value in early design stages. The formula $f = 100/L$, with L in meters, is certainly attractive but yields fundamental frequencies which are too low (Fig. 12).

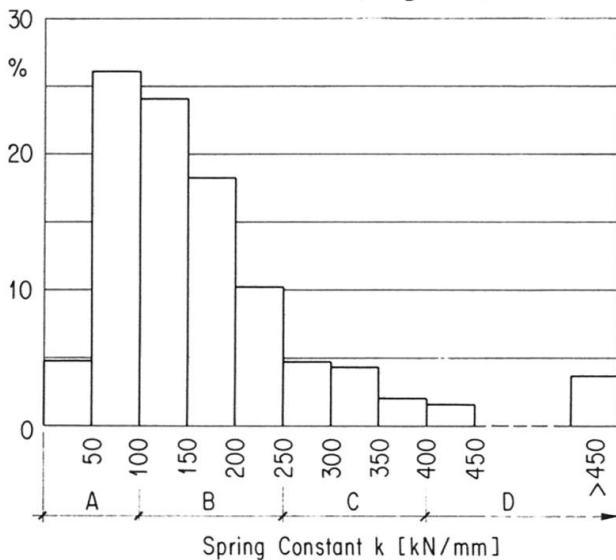

Fig. 10 Spring constant k of the bridges. 187 values; min.: 7 kN/mm, mean: 173 kN/mm, max.: 800 kN/mm. Classification of the flexural stiffness of a bridge: A: flexible, B: average, C: stiff, D: very stiff.

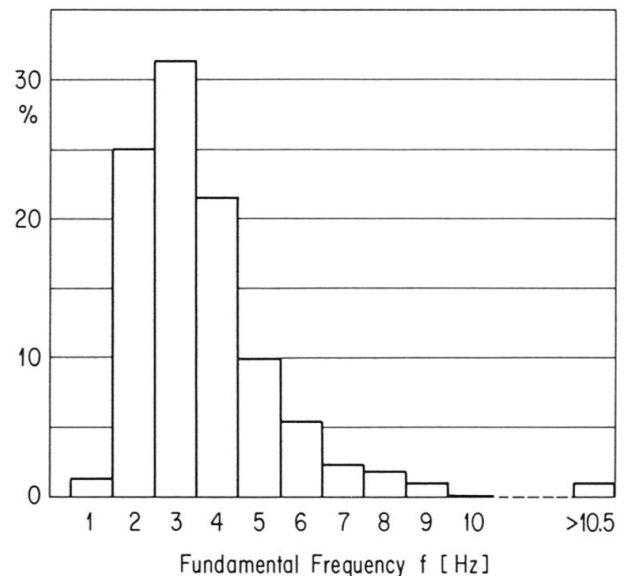

Fig. 11 Fundamental natural frequency f of the bridges. 224 values; min.: 1.23 Hz, mean: 3.62 Hz, max.: 14.00 Hz.

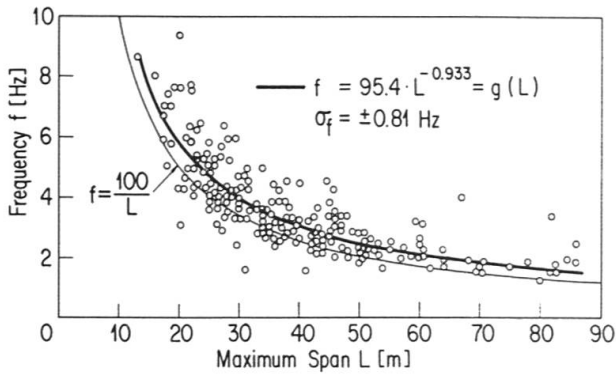

Fig. 12 Fundamental frequency f as a function of the maximum span L . 224 values; σ_f = standard deviation.

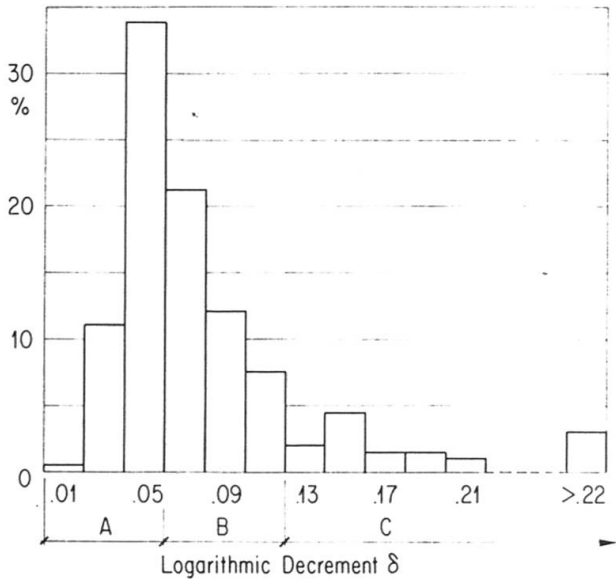

Fig. 13 Logarithmic decrement δ measured on 198 concrete bridges; min.: .019, mean: .082, max.: .360. Classification of a bridge's overall damping: A: weak, B: average, C: strong.

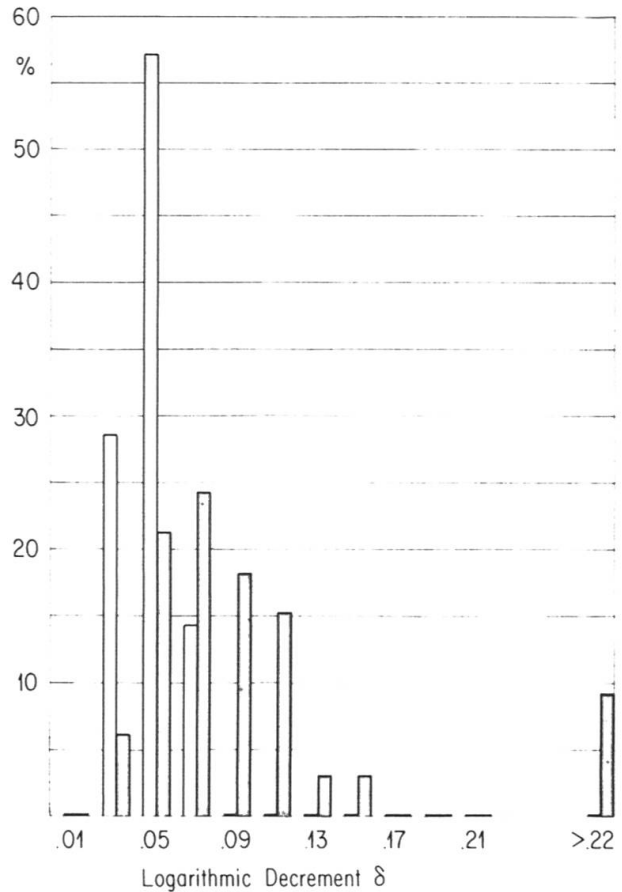

Fig. 14 Logarithmic decrement δ . Distribution of the δ -values of two classes of concrete bridges:

- long, straight, narrow bridges with closed cross section. 21 values; min.: .030, mean: .048, max.: .079.
- short, curved and/or skewed, wide bridges. 33 values; min.: .037, mean: .100, max.: .300.

3.2.3 Damping

The distribution of the logarithmic decrement δ , determined from the free decay process of 198 concrete bridges is shown in Figure 13. Since the δ -values are scattered over a considerable range, an attempt was made to separate the bridges with relatively strong damping from those with relatively weak damping.

Considering the super-structure of a bridge as a vibrating body, overall damping can be separated into internal or structural damping and external or system damping. Thus, structural damping is due to energy dissipation during all kind of vibrations of the super-structure (longitudinal flexure and torsion, transverse vibrations), and system damping is due to energy dissipation during relative movements between super and sub-structures and during all kind of vibrations of the sub-structure elements. As only concrete bridges were included, material damping was not considered. Since the corresponding information was lacking, the influence of the vibrational amplitude or of the relation between this amplitude and the maximum span on damping could not be taken into account. As will be seen later, this influence does not seem to predominate compared with the factors actually under consideration.



Concerning structural damping it was found that bridges responding predominantly in a longitudinal mode of flexure have on the average a smaller logarithmic decrement than bridges which respond in a superposition of modes of longitudinal flexure, torsion and transverse flexure: Straight structures with narrow, closed cross sections showed a mean $\delta = .063$ ($p = 1\%$), curved or skewed bridges with wide cross sections a mean $\delta = .087$ ($p = 1.38\%$).

The EMPA data bank does not contain the necessary information to investigate system damping in detail. The type of the bearing constructions and the relative stiffness of the piers for example are often not given in the test reports. Picking up an idea of Green [6] and confirming his results it was found that the total length of a bridge suitably indicates the damping to be expected: Long bridges with a total length of more than 125 m showed a mean $\delta = .056$ ($p = 0.89\%$), short bridges with a total length of less than 75 m a mean $\delta = .098$ ($p = 1.56\%$). Although the total length of a bridge surely influences the above mentioned parameters of structural damping, it presumably also reflects influences of system damping: The long structures have an average of 0.26 supports per 10 m bridge length, the short ones a corresponding value of 0.60.

Figure 14 gives the δ -distributions of two classes of bridges, formed by combining the parameters of structural damping and the total length. These two classes seem to have rather well separated mean values and distributions of overall damping.

3.2.4 Dynamic Increments

After eliminating the results of non-standard tests and those measured on other than concrete bridges, the maximum dynamic increments of 167 test series with the vehicle moving on the undisturbed pavement and of 162 series with the vehicle crossing a plank were retained. Before trying to interpret the measured dynamic increments ϕ , all values also had to be eliminated, where a falsifying influence of the location of the measurement point in the bridge cross section was to be expected. With the measurement point lying outside the region of direct influence of the test vehicle, the resulting ϕ will be too high to a lesser or greater extent depending on the transverse bending stiffness of the bridge. Therefore, only data corresponding to $\alpha \leq 0.8$ was retained (see Figure 8 for the definition of α).

To begin with, the relationship between the dynamic increment ϕ and the mean span L_m of the bridge was investigated. It can easily be seen from Figure 15 that this relationship does not correspond to the function implied from the present Swiss Code [7]. Comparison of the code provision for ϕ with measured peak values is only possible qualitatively. As the static load associated with the dynamic increments is not the same for code and tests, Figure 15 cannot be used for a quantitative comparison.

It was soon noted that the fundamental frequency is an important parameter influencing the response of a bridge to the passage of a test vehicle. A general explanation for this observation is as follows:

- The bridge as well as the vehicle are mechanical mass/spring/damper systems whose dynamic behavior is determined by natural modes.

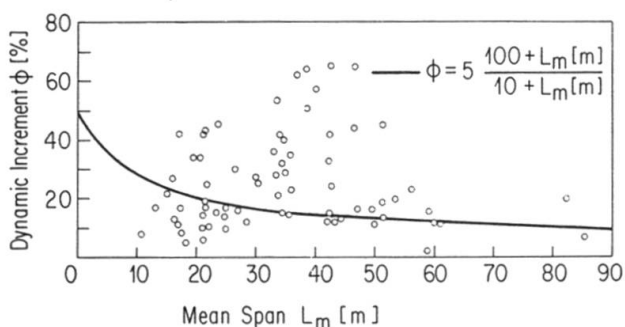

Fig. 15 Dynamic increments ϕ for passages without a plank as a function of the mean span L_m . 73 values of concrete bridges, $\alpha \leq 0.8$. The solid line indicates the relation given in [7].

- The bridge response will therefore be influenced by the relationship between the frequencies of these modes. Stated differently, one of the conditions to be fulfilled for a distinct bridge response is a matching of the frequencies of dynamic wheel loads and a bridge natural mode.

The natural modes of the EMPA test vehicles were presumably scattered over a relatively narrow frequency band: The vehicles were all fully loaded two-axle tip trucks with leaf springs. Under normal conditions of pavement roughness, the dynamic wheel loads of such vehicles predominantly occur in two frequency ranges: a) In the range of the body bounce frequency between ≈ 2 and ≈ 5 Hz and b) in the range of the wheel hop frequency between ≈ 10 and ≈ 15 Hz. The body bounce mode of a vehicle is excited by relatively long, the wheel hop mode by relatively short waves of the roadway unevenness. Depending on the vehicle speed, an unevenness of a certain wavelength may be effective in both ranges. As an example of special interest, a plank excites body bounce vibrations for low vehicle speeds and almost pure wheel hop vibrations for speeds $v \geq 40$ km/h.

Figure 16 gives the maximum dynamic increments ϕ of test series on the undisturbed pavement as a function of the bridge's fundamental frequency: The curve encompassing the measured values shows a clear peak in the region of 2.5...4 Hz, i.e. in the region of the vehicle's body bounce frequency. The statement that the short wave amplitudes of normal pavements are too small to significantly excite the vehicle's wheel hop mode is based on one single measurement value (14 Hz) in the corresponding frequency range.

From the equivalent diagram for the test series with a plank lying on the roadway (Fig. 17) it can be seen that a first resonance peak lies in the range between 1.5 and 3 Hz and a second peak at frequencies above 7 Hz, i.e. the peaks occur at lower frequencies than expected.

As a leaf sprung truck is a nonlinear mechanical system, its natural frequencies are dependent on the excitation amplitude. EMPA experiments have shown that the natural frequencies of two-axle trucks decrease with increasing amplitude. The frequencies of the vehicle's body bounce and wheel hop modes (and of bridges exhibiting maximum response) are therefore lower if the excitation is caused by a 50 mm-plank than by the comparatively small roughness amplitudes of a usual pavement.

Keeping these facts in mind, the interpretation of EMPA test results can be summarized as follows: A highway bridge exhibits a pronounced dynamic response only if its fundamental frequency lies in the same region as one of the two vehicle modes of concern and if the vehicle speed and pavement roughness are "tuned" to each other so that the corresponding vibrations of the vehicle will be excited.

It can also be seen from Figures 16 and 17 that the dynamic increments do not follow a one or two-peaked resonance curve. Rather they are scattered below the

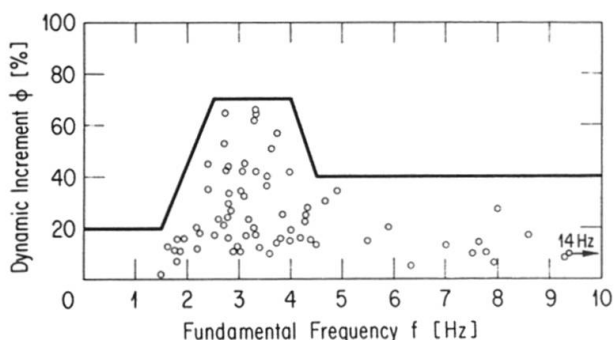

Fig. 16 Dynamic increments ϕ for passages without a plank as a function of the fundamental frequency f . The same data as given in Figure 15.

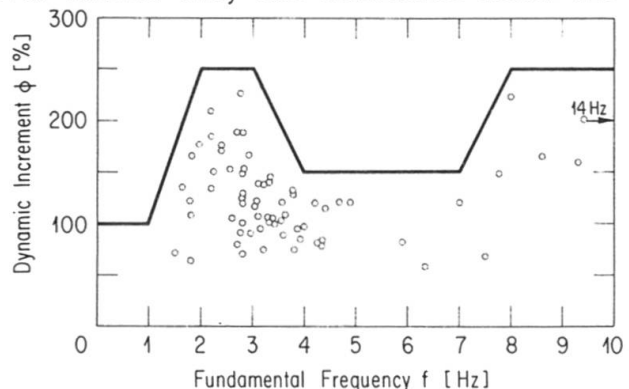

Fig. 17 Dynamic increments ϕ for passages with a plank as a function of the fundamental frequency f . 69 values for concrete bridges, $\alpha \leq 0.8$.



peaks. Unfortunately, the information available does not suffice to determine the reasons for this scatter in detail. Nevertheless, an attempt was made to evaluate the influence of three parameters available in the EMPA data bank [5]. It was found that damping does not appear to exert an important influence on the dynamic increment and that straight, beam-type bridges respond only slightly more strongly than more complicated structures. Concerning the influence of the pavement roughness on dynamic increments for passages without a plank, the investigation showed that bridges having medium or poor pavements generally respond more strongly than those having smooth pavements.

The solid curves indicated in Figures 16 and 17 were proposed to be integrated qualitatively in the new version of the Swiss Code on Highway Bridge Loading. The curve shown in Figure 16 is similar to the curve used in the 1979 Ontario Highway Bridge Design Code [8]. It may be mentioned that these two curves were developed independently and that they are based on two different sets of experimental data.

4. LATEST DEVELOPMENTS

4.1 Digital Signal Analysis

A review and analysis of previous tests yielded valuable insight but also disclosed the fact that some important parameters had not sufficiently been taken into account. Stated differently: It is not possible to fully understand a process like the passage of a truck over a bridge by merely measuring the bridge response. Analysis of such a dynamic process demands knowledge of at least two of its three basic elements: 1) Excitation (input function), 2) transfer behavior of the structure (modal parameters), 3) response (output function).

Development of the Fast-Fourier-Transform algorithm (FFT) by Cooley and Tukey in 1965 decisively advanced the methods available for experimentally-based analysis of dynamic processes. Today, rather sophisticated equipment such as FFT-analyzers and modal-analysis systems (which even allow the linking of experimental and theoretical analyses) can be employed [9]. Although a complete experimentally-based analysis of the dynamic process under consideration is not yet possible, many advances have been made at EMPA along the path from manual to digital signal analysis, both in the time and frequency domains.

Dynamic tests on bridges generally involve a rather large number of measurement channels, for example 8, 16 or even more. As on-line processing of so many simultaneous signals is usually not possible in the field, they have to be stored on magnetic tape. Therefore, as a first step, a PCM-system (Pulse Code Modulation) was acquired at EMPA in 1977. With this system, up to 32 dynamic time signals can be digitized and stored on magnetic tape.

The next steps were coupling the PCM-system to a computer (1979) and writing the software to allow the same time domain data processing of the bridge response signals as was performed earlier by hand. Obviously, the main advantage of automating this processing is the ease in treating many simultaneously measured signals. In addition, digital filtering of crawl test signals provides a reliable means of evaluating the static comparative value A_{stat} (see Section 2.3, "Data Processing").

Attempts were then concentrated on the determination of excitation and transfer functions. The problem of measuring the excitation function was solved by acquiring an opto-electronic system which establishes the dynamic wheel loads of two-axle test vehicles by measuring the distance between axle and roadway surface just beneath the tires. Making use of the force/deflection relationship of the tire, the measured deflection can then be transformed into force, i.e. dynamic wheel load. The 4-channel system was extensively used within the framework of a research program but has not yet been introduced into the standard dynamic tests on highway bridges.

The transfer function, a complex function of frequency, is calculated from the frequency spectra of an excitation and a response signal. Hence, the measured time signals must be transformed into the frequency domain. This transformation can be executed by a hard-wired FFT-analyzer typically in much less than one second. A two-channel FFT-analyzer was coupled to the same computer as the PCM-system in 1982. The next section gives an example of the information available through analysis of response signals in the frequency domain.

There are two reasons why complete analysis of a truck's passage over a bridge is not yet possible: a) The transfer behavior of a bridge (which is the process element of primary importance) cannot be determined if a moving truck is used for exciting the structure and b) the transfer behavior of a bridge can only be calculated with a modal-analysis system.

It was already mentioned that a transfer function is computed from the spectra of excitation and response. To establish the necessary spectra, the corresponding time signals have to be measured at a given location of the structure for a certain minimum time duration. Assuming a frequency resolution of at least $\Delta f = 0.05$ Hz, this duration has to be a minimum of $T_c = 1/\Delta f = 20$ s. To reach a reasonable reliability of the spectrum, the duration should be a multiple of this minimum value. In addition, the time signal is assumed to be stationary and ergodic. It is therefore obvious that instead of a moving truck, a fixed vibration generator or a device producing impulse-type forces has to be used as the excitation means. EMPA has a servo-hydraulic vibration generator (± 5 kN max. force) at its disposal.

Still, there remains the problem of the modal-analysis system. To describe the transfer behavior of a structure, a dynamic model must be defined. For a structure like a bridge, the required minimum number of points to build up a suitable model (which also fixes the number of degrees of freedom) is rather large. It is then necessary to calculate the transfer functions for every possible pair of points defining the model. In practice it suffices to keep the point of excitation constant and to measure the structural response at all points (or vice versa). An individual transfer function can be calculated with an FFT-analyzer, but to put all the transfer functions together into a transfer matrix, a modal-analysis system is required. Such a system will presumably be purchased at EMPA in 1984.

After having determined the transfer matrix by utilizing a suitable excitation it will then be possible to analyze, among many other problems of structural dynamics, the passage of a truck over a bridge.

4.2 Example of Frequency Domain Analysis

Dynamic tests were performed on the Ponte di Campagna Nova in 1983. This structure, located near Chiggiogna (Canton Ticino), is a simply-supported beam of post-tensioned, cast-in-place concrete with a single 45 m span and a horizontally curved longitudinal bridge axis (100 m radius). The fixed bearings as well as the movable roller bearings are of steel construction. The one-cell box-girder cross section has a constant height of 2.0 m and a width of 8.9 m.

Using inductive transducers, deflection was measured at mid-span on the two box-cell webs and at the parapets. As a supplement to the latest standard test methods, acceleration was measured at the same points and in addition at a quarter-point of the span at the parapets. The two-axle test vehicle had an axle spacing of 4.5 m, a gross weight of 160 kN and a tire pressure of 6.5 bar. The vehicle was driven along the longitudinal bridge axis on the finished bituminous pavement, and for some tests over a plank of cross section 50 mm x 290 mm placed at mid-span.

With a spring constant of $k = 54$ kN/mm, the bridge can be classified as flexible (Fig. 10).



The dynamic behavior of the structure was first analyzed in the time domain by processing the deflection signals. From the almost purely sinusoidal free decay process (see Fig. 7), frequency and damping of the fundamental bridge mode could be evaluated: $f_0 = 2.05$ Hz, $\delta = .040$ resp. $\rho = 0.64$ %. Comparison with Figure 12 shows that the frequency is slightly lower than expected. According to Figure 13, damping can be classified as "weak". Maximum values of the dynamic increment ϕ for the webs were $\phi = 19$ % at $v = 28$ km/h for passages without a plank and $\phi = 212$ % at $v = 7$ km/h for passages over the plank. These values can be compared with Figures 16 and 17.

To analyze the dynamic bridge behavior in the frequency domain, acceleration signals were utilized instead of deflection signals. According to the laws of physics, acceleration is much more sensitive to higher bridge modes than deflection. It can be seen from Figure 18 that for the free decay process, the frequency content of a displacement signal is significant only for $0 \text{ Hz} < f < \approx 4$ Hz, whereas the acceleration spectrum yields information over the entire frequency band considered, i.e. $0 \text{ Hz} < f < 20$ Hz.

The aim of frequency domain analysis was first to identify all natural modes of concern of the bridge and then to investigate the influence of the vehicle on the structure's vibrational behavior. Transformation of the corresponding acceleration time signals, i.e. calculation of the PSD-spectra (Power Spectral Density) was performed with the Nicolet 660A-FFT-analyzer. To determine the mode shapes, transfer functions were established, whereby one of the response signals was taken as a reference signal (instead of the usual excitation signal) and the transfer functions to every other response signal were calculated. This yielded the amplitude and phase of these response signals relative to the reference signal for all frequencies.

Analysis of a free decay process of $T_C = 20$ s duration in this way provided the frequencies (with a resolution of $\Delta f = 1/T_C = 0.05$ Hz) and shapes of the following modes (Fig. 18):

| | |
|--|---|
| $f_0 = 2.05$ Hz, 1. Longitudinal flexure | $f_3 = 13.65$ Hz, 2. Torsion |
| $f_1 = 7.40$ Hz, 2. Longitudinal flexure | $f_4 = 16.65$ Hz, 3. Longitudinal flexure |
| $f_2 = 8.55$ Hz, 1. Torsion | $f_5 = 19.60$ Hz, 3. Torsion |

To allow easy interpretation of various spectra of interest, the calculation and presentation methods had to be normalized to a certain degree. The minimum duration of the time signals of interest, $T_C = 8$ s, dictated the cut-off frequency of the spectra to $f_C = 50$ Hz and the frequency resolution to $\Delta f = 0.125$ Hz. Figure 19 shows five spectra, all calculated from one single time signal with $T_C = 8$ s, but from five different test stages.

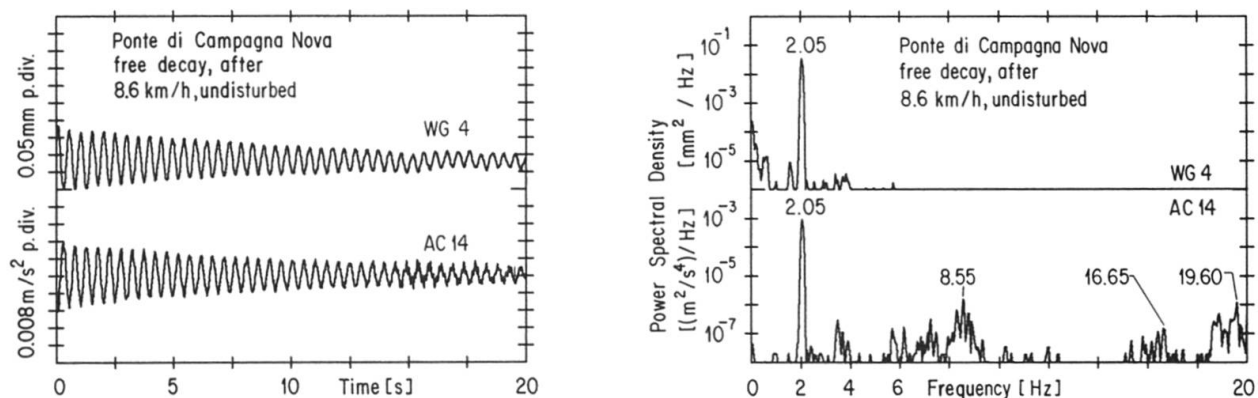

Fig. 18 Time signals and PSD-spectra of displacement (WG4) and acceleration (AC14) measured at the mid-point of the Ponte di Campagna Nova at a parapet. The frequencies of the modes having non-zero amplitudes at the measurement point are indicated.

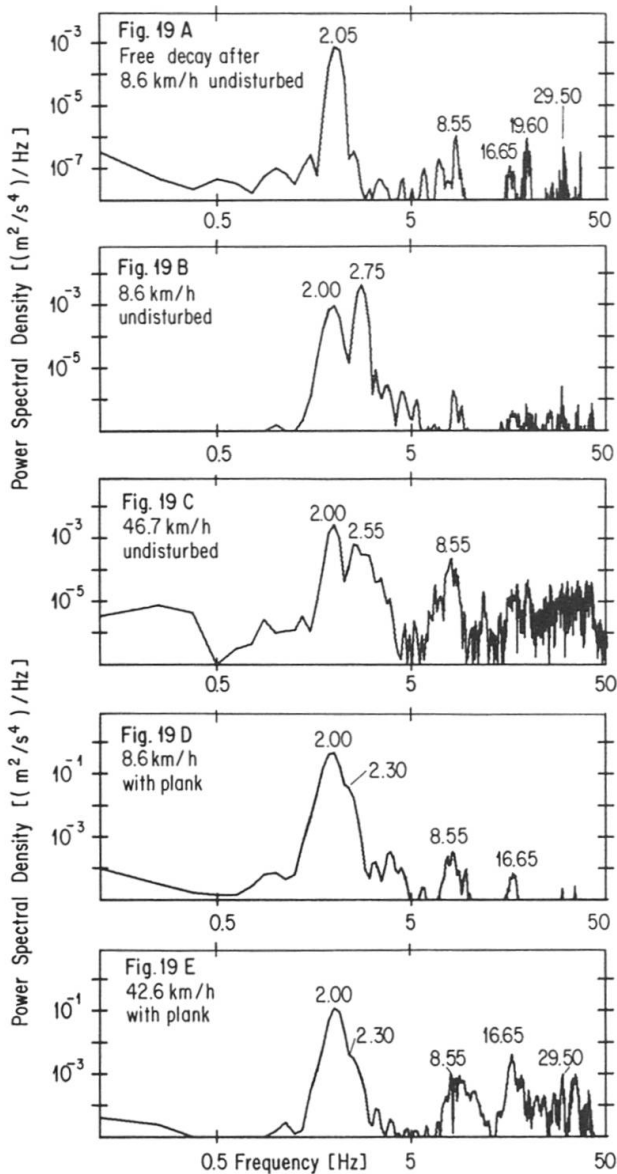

Fig. 19 PSD-spectra of acceleration (AC14) measured at the mid-point of the Ponte di Campagna Nova at a parapet.

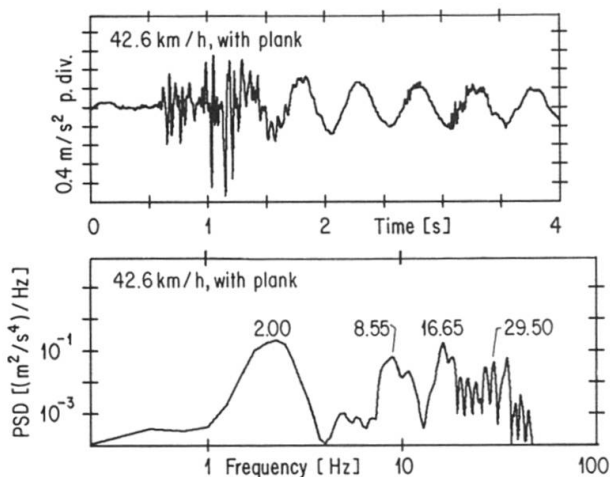

Fig. 20 Time signal and PSD-spectrum of acceleration (AC14).

The behavior of the freely vibrating structure is shown in Figure 19A. Comparing this PSD-spectrum with the one shown in Figure 18, differences in frequency range and frequency scaling (lin/log) have to be taken into account. Aside from the natural modes already established from the 20 Hz-spectra, the 50 Hz-spectra allowed identification of a transverse flexure mode with $f_6 = 29.50$ Hz.

During a slow passage of the test vehicle on the undisturbed pavement, the frequency of the fundamental bridge mode decreases to $f_0' = 2.00$ Hz and the bridge response is strongly influenced by a forced vibration with $f_v = 2.75$ Hz which can be attributed to the vehicle's body bounce mode (Fig. 19B).

With increasing speed, body bounce forced vibrations occur over an expanded frequency range $2.3 \text{ Hz} < f_v < 4 \text{ Hz}$ with a peak density at $f \approx 2.55$ Hz (Fig. 19C). At the same time, the bridge response at frequencies of more than 5 Hz notably increases, which can be attributed to the increased action of dynamic wheel loads in the vehicle's wheel hop mode.

Passing over the plank generates body bounce vibrations with a peak frequency of $f_v \approx 2.30$ Hz. Consequently, a clear separation of the natural and forced vibrations in the bridge response is hardly possible. Comparison of Figures 19D and 19E shows that body bounce forced vibrations decrease with increasing speed. Concerning the region of wheel hop vibrations, $f > 5$ Hz, the contrary is true, as was also observed for passages without a plank.

Closer analysis of the bridge response during the vehicle's passage over the plank with $v = 42.6$ km/h shows that the acceleration density of the vibrations with $f_0' = 2.00$ Hz and $f_4 = 16.65$ Hz is practically equal (Fig. 20, $T_C = 4$ s, $\Delta f = 0.25$ Hz). Phase lags between the various signals of approximately 90 degrees indicate that the vibration with $f \approx 8.5$ Hz is a superposition of the bridge's natural torsional vibration $f_2 = 8.55$ Hz and a flexural vibration forced by the vehicle with the same frequency (flutter).



It can therefore be confirmed that a) the center frequency of body bounce vibrations decreases both with increasing speed and amplitude of long-wave roughness and b) significant wheel hop vibrations occur both with passages on usual pavements and over a plank only at relatively high speed.

The dynamic behavior of the Ponte di Campagna Nova can be evaluated as follows:

With the pavement conditions that prevailed on the day of measurements, the dynamic sensitivity of the bridge to traffic loads can be described as average. The main excitation frequency $f_v = 2.5 \dots 2.8$ Hz is sufficiently removed from the fundamental frequency of the loaded bridge $f_0' = 2.00$ Hz so as to rule out the occurrence of resonance phenomena.

With a deterioration of the pavement condition, it can be expected that the bridge will yield a high or very high dynamic response to traffic loads. Firstly, with sufficiently large pavement roughness amplitudes the main excitation frequency will decrease and thus excite the fundamental resonance of the bridge. Furthermore, at vehicle speeds greater than 30...40 km/h, the occurrence of higher excitation frequencies can be expected. These in turn will excite especially the third longitudinal flexure mode ($f_4 = 16.65$ Hz) and the transverse flexure mode ($f_6 = 29.50$ Hz).

Bridge vibrations at $f_4 = 16.65$ Hz lead to a bending moment distribution which does not correspond with that of a simply-supported beam. In addition, the simultaneous excitation of the fundamental mode and the third longitudinal flexure mode can lead to considerable dynamic forces at the bearings. According to the concepts of dynamic equilibrium, the magnitude of the dynamic support reactions depends upon the inertial forces, respectively the accelerations. At certain instants of time, phase coincidence between the movements in both of the above-mentioned modes will occur in the support region. This will result in a summing of the positive respectively negative dynamic support reactions.

REFERENCES

1. ROŠ M., Versuche und Erfahrungen an in der Schweiz ausgeführten Stahlbauten 1922 - 1945, Technische Kommission des Verbandes Schweiz. Brückenbau- und Stahlhochbau-Unternehmungen, Zürich, 1951.
2. ROŠ M., Versuche und Erfahrungen an ausgeführten Eisenbetonbauwerken in der Schweiz 1924 - 1937, EMPA-Report Nr. 99, 1937, with five supplements 1939, 40, 43, 45, 47.
3. RÖSLI A., Über das dynamische Verhalten von vorgespannten Brücken, 6. IABSE-Congress, Stockholm, 1960, Preliminary Report.
4. CANTIENI R., Durchbiegungsmessung von Brücken - ein laserstrahlgestütztes System im Vergleich mit konventionellen Methoden. Material und Technik, Vol. 7, 1979, Nr. 3.
5. CANTIENI R., Dynamic Load Tests on Highway Bridges in Switzerland - 60 Years Experience of EMPA, EMPA-Report Nr. 211, 1983.
6. GREEN R., Dynamic Response of Bridge Superstructures, Ontario Observations, Proc. Symp. on Dynamic Behaviour of Bridges, Transport and Road Research Laboratory, Suppl. Report SR 275, Crowthorne, UK, 1977.
7. SCHWEIZERISCHER INGENIEUR- UND ARCHITEKTENVEREIN, Normen für die Belastungsannahmen, die Inbetriebnahme und die Überwachung der Bauten, Nr. 160, Zürich, 1. Mai 1970.
8. Ontario Highway Bridge Design Code, 1979, Published by the Ontario Ministry of Transportation and Communications, Downsview, Ontario, 1979, January.
9. PROCEEDINGS of the 1st International Modal Analysis Conference, Orlando, Florida, USA, 1982, Published by Union College, Schenectady, N.Y.