

Zeitschrift: IABSE proceedings = Mémoires AIPC = IVBH Abhandlungen
Band: 8 (1984)
Heft: P-79: Water tower at Tyrsted, Denmark

Artikel: Water tower at Tyrsted, Denmark
Autor: Thomsen, Kjeld
DOI: <https://doi.org/10.5169/seals-38341>

Nutzungsbedingungen

Die ETH-Bibliothek ist die Anbieterin der digitalisierten Zeitschriften. Sie besitzt keine Urheberrechte an den Zeitschriften und ist nicht verantwortlich für deren Inhalte. Die Rechte liegen in der Regel bei den Herausgebern beziehungsweise den externen Rechteinhabern. [Siehe Rechtliche Hinweise.](#)

Conditions d'utilisation

L'ETH Library est le fournisseur des revues numérisées. Elle ne détient aucun droit d'auteur sur les revues et n'est pas responsable de leur contenu. En règle générale, les droits sont détenus par les éditeurs ou les détenteurs de droits externes. [Voir Informations légales.](#)

Terms of use

The ETH Library is the provider of the digitised journals. It does not own any copyrights to the journals and is not responsible for their content. The rights usually lie with the publishers or the external rights holders. [See Legal notice.](#)

Download PDF: 30.03.2025

ETH-Bibliothek Zürich, E-Periodica, <https://www.e-periodica.ch>

Water Tower at Tyrsted, Denmark

Réservoir d'eau à Tyrsted, Danemark

Wasserturm in Tyrsted, Dänemark

Kjeld THOMSEN

Consulting Engineer
International Steel Consulting A/S
Copenhagen, Denmark

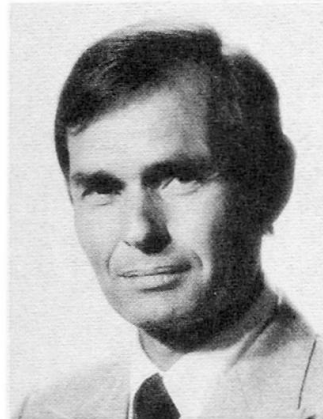

Kjeld Thomsen got his M.Sc. in 1960 at the Technical University of Denmark. Associate Professor 1967–1975. Author of a complete set of textbooks on Structural Steel design. Practicing and consulting engineer since 1960. Founder of International Steel Consulting A/S in 1967. Honoured with the ECCS award for the design of Steel Structures 1979, 1981 and 1983, and with Professor Ostenfeldt's gold medal for engineering research 1979.

SUMMARY

This paper presents a brief description of a water tower built in steel with a net capacity of 2000 m³. The water tank has the outstanding shape of a cut diamond as opposed to the traditional types of conical, spherical or cylindrical shells. The support system consists of a slender central column of octagonal cross section and eight tubular columns forming a conical fan.

RÉSUMÉ

Cet article décrit un réservoir d'eau, en acier, contenant un volume net de 2000 m³. Le réservoir a la forme d'un diamant taillé, contrastant avec les solutions conventionnelles en forme de cône, sphère ou cylindre. Le système d'appuis comprend une colonne centrale octogonale élancée en caisson et huit minces colonnes tubulaires formant un éventail.

ZUSAMMENFASSUNG

Dieser Beitrag beschreibt einen neuen Wasserturm im Stahlbau mit einer Volumenkapazität von netto 2000 m³. Der Wasserbehälter hat die besondere Form eines geschliffenen Diamanten im Gegensatz zu den traditionellen Gestaltungen, die konische, sphärische oder zylindrische Schalen einschliessen. Das Unterstützungssystem besteht aus einer relativ schlanken Zentralsäule mit polygonalem Kastenquerschnitt und acht Rohrsäulen in Fächerform.



1. INTRODUCTION

The new water tower at Tyrsted with a tank capacity of 2.000 m³ will be integrated in the water supply system for Horsens city, located at the east coast of Jutland and with a population of 50.000. The Tyrsted tower is primarily required to replace minor outdated water works in the outskirts of Horsens and supply about 15.000 inhabitants.

Tyrsted is located 61 m above sea water level at a distance of 5 km south west of central Horsens. As Horsens city is well below the level at Tyrsted the chosen level for the elevated tank of 89 m/77m is sufficient to provide the required pressure at the consumers.

At the preliminary design stage a cost estimate was carried out to compare price level for a water tower in steel with that of a tower in concrete. The proposal in steel, however, turned out to be more economic even in the outstanding architectural concept visualized for the steel tower.

2. ARCHITECT'S INTENTION

The architect's intention was to shape the water tower with a light sculptural appearance as opposed to conventional rather monolithic concrete tower designs. This was considered of major importance due to the location in an open rather flat landscape in which the tower will be a dominating landmark.

The octagonal form of the centre column and the tubular columns in the conical fan match the geometry of the elevated tank shaped as a simplified cut diamond. The modified diamond shaped tank satisfied both hydraulic and aesthetical demands. The light reflections and shadows of the plane faces will underline a pleasant everchanging appearance of the selected octahedron form.

3. STRUCTURAL CONCEPT

The desired diamond shape of the elevated water tank is approximately achieved by the combination of two octahedrons with a maximum diameter at the joint level of 23.4 m decreasing to 2.3 m at the octagonal transition to the centre column. The diameter at tank top is 13.4 m and the total height 28.05 m. The tank is supported on the 15.75 m long centre column with octagonal shaped box section and eight tubular columns with diameter 450 mm located in the panel intersection planes forming a conical fan. The fan diameter is 6.5 m at foundation level increasing to 14.1 m at the tank support sockets, corresponding to a support position 0.55 times the height of the lower octahedron above the tank bottom.

Despite the apparent simple support system the statical interaction is rather complex for vertical load as well as for horizontal load.

The centre column is rigid restrained in the tank and at foundation level, whereas the fan columns are elastic restrained in the tank and rigid restrained in the foundation. The distribution of the vertical load reaching 2.140 t depends on the elastic interaction

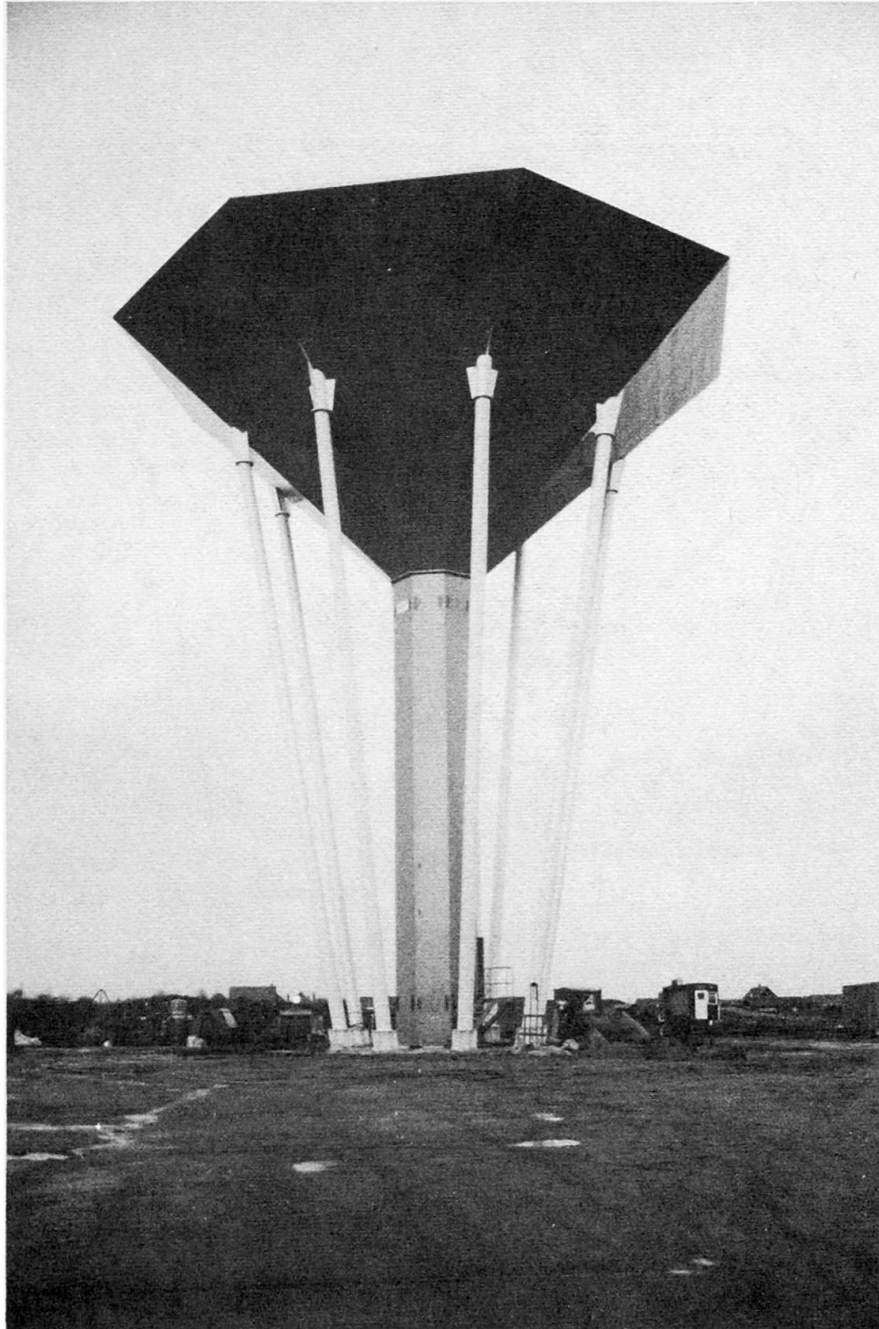

Figure 1. Water tower in the final shape after erection.

in the system. The maximum axial load in the fan columns occur if they are assumed perfect straight, whereas the maximum axial load in the centre column occurs if an unavoidable initial deflection is foreseen in the fan columns. The axial loads in the fan columns are statically balanced by means of a star shaped tubular bracing system arranged inside the tank at the level of the support nodes.

The wind load and exterior second order bending moments due to deflection and sloping water surface are resisted by the centre column reinforced by means of the stringer system of fan columns. The stringer reinforcement causes a substantial reduction of the free bending moments, the lateral deflection and the buckling

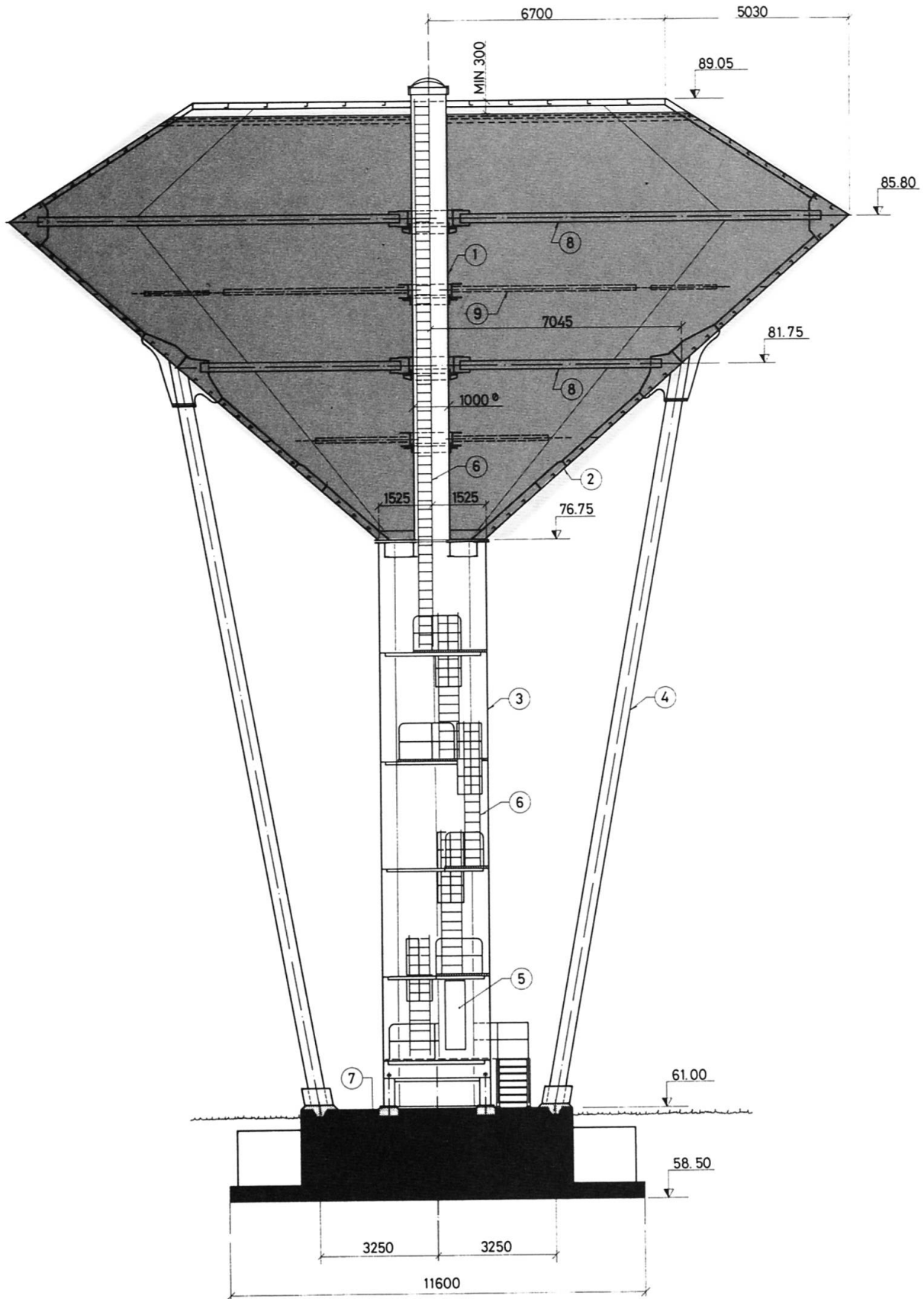

Figure 2. Vertical section in water tower. 1. Centre tube in tank. 2. Tank panel. 3. Welded centre column. 4. Tubular fan columns ϕ 457 x 14.2 mm. 5. Access door. 6. Ladder. 7. Concrete foundation. 8. Bracing members ϕ 244 x 6.3 mm. 9. Panel support members ϕ 100 mm.

length of the centre column. As the impact factor to be considered for gust wind reaches 6.7 due to a rather low frequency for the first mode of natural vibration, this interaction has substantial effect on the plate dimensions in the centre column.

The plate panels of the tank are provided with interior longitudinal and transverse stiffeners in a narrow mesh to provide sufficient strength towards the combined influence of bending and in plane sectional forces. The maximum internal pressure reaches 13 t/m^2 at the tank bottom. The plate panels of the lower octahedron are 13.0 m long and 9.09 wide at the intersection plane and the plate thickness varies from 10 mm to 25 mm at the bottom.

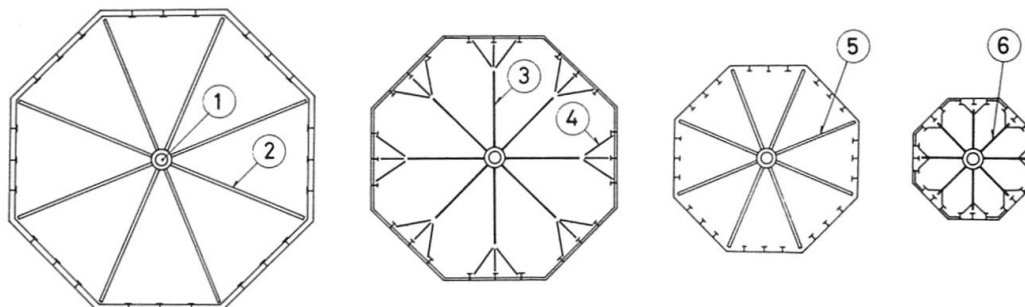

Figure 3. Horizontal bracing systems in the tank. a. level 85.80, b. level 83.75, c. level 81.85, d. level 79.75. 1. Centre tube. 2. Pipe ϕ 244 x 6.3 mm. Round bar ϕ 100 mm. 4. Round bar ϕ 65 mm. 5. Pipe ϕ 244 x 6.3 mm. Round bar ϕ 100 mm.

Intermediate support of the plate panels is arranged at three levels to reduce the size of the primary longitudinal stiffening beams and minimize steel consumption in general. The intermediate support located at the level of the fan column joints are octagonal shaped plane frames out of sections half HE 900 B. The two other support planes are located 2 m above and 2 m below this level and arranged as radial bracing in plain round bar sections.

The 15.75 m long centre column is an all welded box section with octagonal shape and side length 1166 mm. The plate thickness varies from 16 mm at the top to 20 mm at the bottom. Transverse diaphragms are arranged at intervals of 3.0 m and longitudinal stiffeners are provided along the centerline of each panel to achieve required safety against buckling. The 20.6 m long fan columns are welded tubes with diameter 450 mm and wall thickness 14 mm.

4. STRUCTURAL ANALYSIS

Compared with the traditional types of reticulated shell water tanks the present folded plate structure with interior bracing involves a number of more complex statical and dynamical interaction problems. A detailed presentation of the analysis carried out will be beyond the scope of this article. However, some interesting features of the statical behaviour shall be briefly mentioned.



The orthotropic plate panels were analysed and designed to resist a combination of membrane forces and bending moments due to internal water pressure and external wind load. The moments were determined with due regard to the elastic support on the transverse stiffeners and second order bending was considered taking into account an initial deflection of the individual plate sections of 0.002 times the shortest distance between boundary stiffeners.

At two levels $\varnothing 100$ plain round bar radial bracing members in angular distance of 45° are connected to the plate panels via highly stressed 25 mm thick gusset plates of a non conventional configuration. A finite element analysis was therefore carried out to verify adequate strength.

The stresses in the bottom plate were determined by a finite element analysis applying a mesh sufficiently fine to achieve a reliable stress pattern.

The 4 padeyes for the hook up of the tank were located in every second of the outer boundary corners. The radial gusset plate in these corners were extended outside the cover plates to provide space for the padeye above the panel intersection point. The transfer of the hook up load to shear in the intersecting panels is achieved through a complex stress flow in the gusset plate which was determined by finite element analysis.

The resulting bending moments in the centre column as well as the buckling length are substantially affected by the stringer system of fan columns, which counteract the rotation of the tank during sway deflection of the system as shown schematically on figure 4.

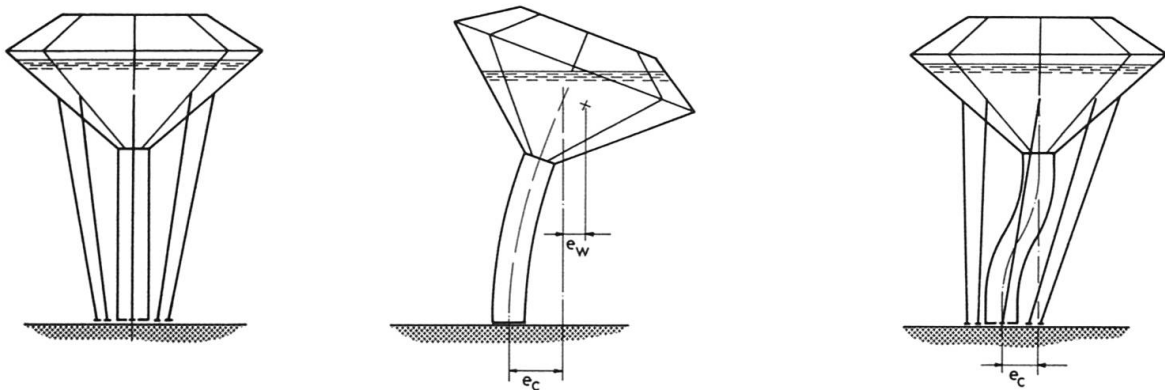

Figure 4. Sway mode of system for horizontal load. a. Nondeformed system. b. Sway mode of system without fan columns. c. Sway mode of system with fan columns.

The buckling length of the centre column is determined considering the elastic restraint in the foundation as well as influence from the water in the tank. The influence from the water under sway deflection is due to the gravity centre being located above the top of the column and the additional overturning effect, because the water table remains horizontal. The buckling length reaches its maximum when the water table in the tank is at level 85,80. Compared to the case with full tank the buckling length increases in this case with 23% due to the very large moment of inertia of the water table.

5. STRUCTURAL DETAILING

The tank geometry, the interior bracing and the support system have called for innovative non-conventional joint detailing not least due to the throughout highly stressed structural components.

The tank panels are provided with horizontal unequal angle section stiffeners at a mutual distance of 500 mm. The angles are elastically supported on 3 radial directed stiffening beams of half IPE 450 sections. The web of the IPE-sections are prepared with cut outs shaped to fit the continuous angles.

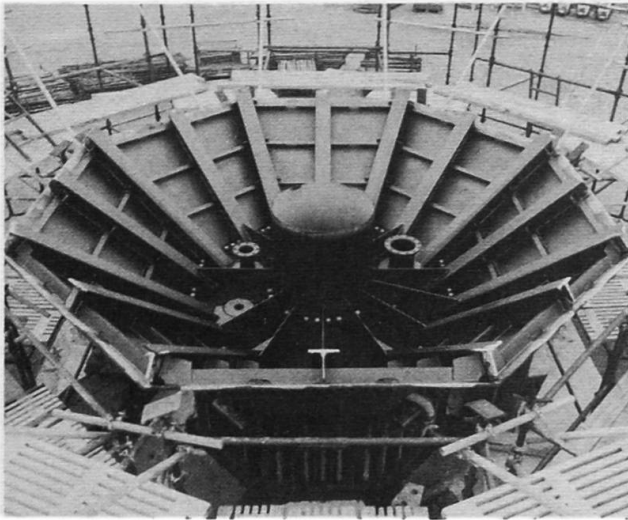

Figure 5. View into tank bottom section.

At the panel intersection lines the angles are joined with gusset plates to the intersecting stiffeners to provide adequate erection tolerances.

Notch holes are generally omitted in corner joints to improve weld quality and reduce weak points of the corrosion protection. However, drainage holes are cut in adequate numbers along all horizontal stiffeners.

The interior bracing members transfer the axial tensile forces, reaching nearly 180 t, to octagonal shaped welded

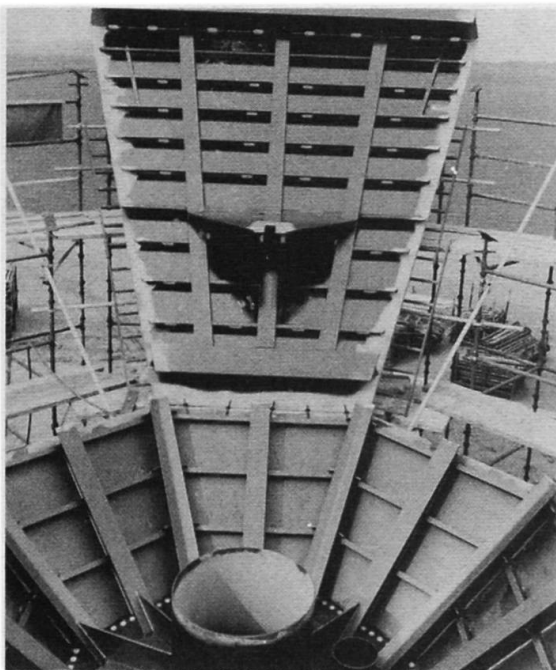

Figure 6. First panel section mounted on site.

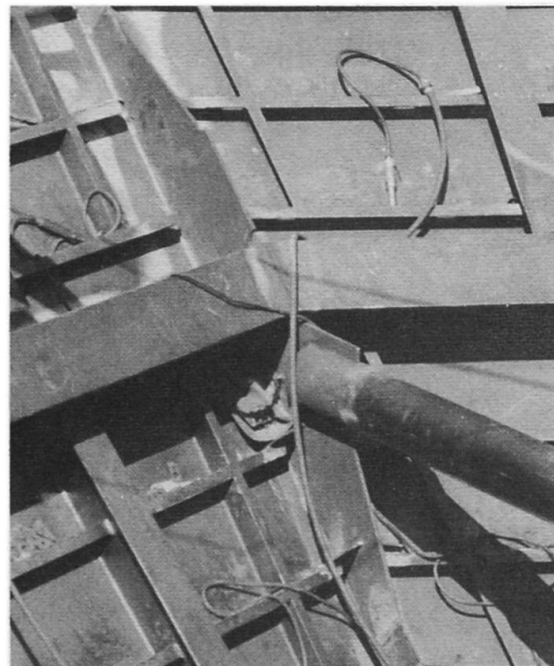

Figure 7. View of bracing joint at panel intersection.



frames supported vertically on reticulated brackets welded to the centre tube in level 83.75 and level 79.75. Clearance to the centre tube has been provided instead of arranging welded on stiffening rings to ease fabrication and mounting. The frames are connected to the brackets by means of bolts in oversize holes. This solution further provided adequate flexibility for level adjustment and minimize second order stress effects.

The bracing system in level 83.75 consists of 100 mm dia. plain round bar systems in angular distance of 45° , which via a gusset plate spreads to a fan of three 65 mm dia. plain round bar members providing the intermediate support of the panel stiffening beams. At level 69.75 the same main bracing is arranged, however with the fan replaced by a triangular shaped 25 mm thick gusset plate enclosing the webs of the three panel stiffening beams. The tubular star bracing systems at the transition level 85.80 and at the fan column support level 81.75 are connected to similar octagonal shaped frames at the centre tube as applies in level 83.75 and 79.75. Vertical gusset plates are provided for the welded connection of the tubular members at the panel intersections.

The tubular fan columns are connected to sockets extending below the tank by means of rigid bolted butt plate joints. Fitness in the butt plate joints can be achieved by means of filler plates and available adjustment clearance at the column base.

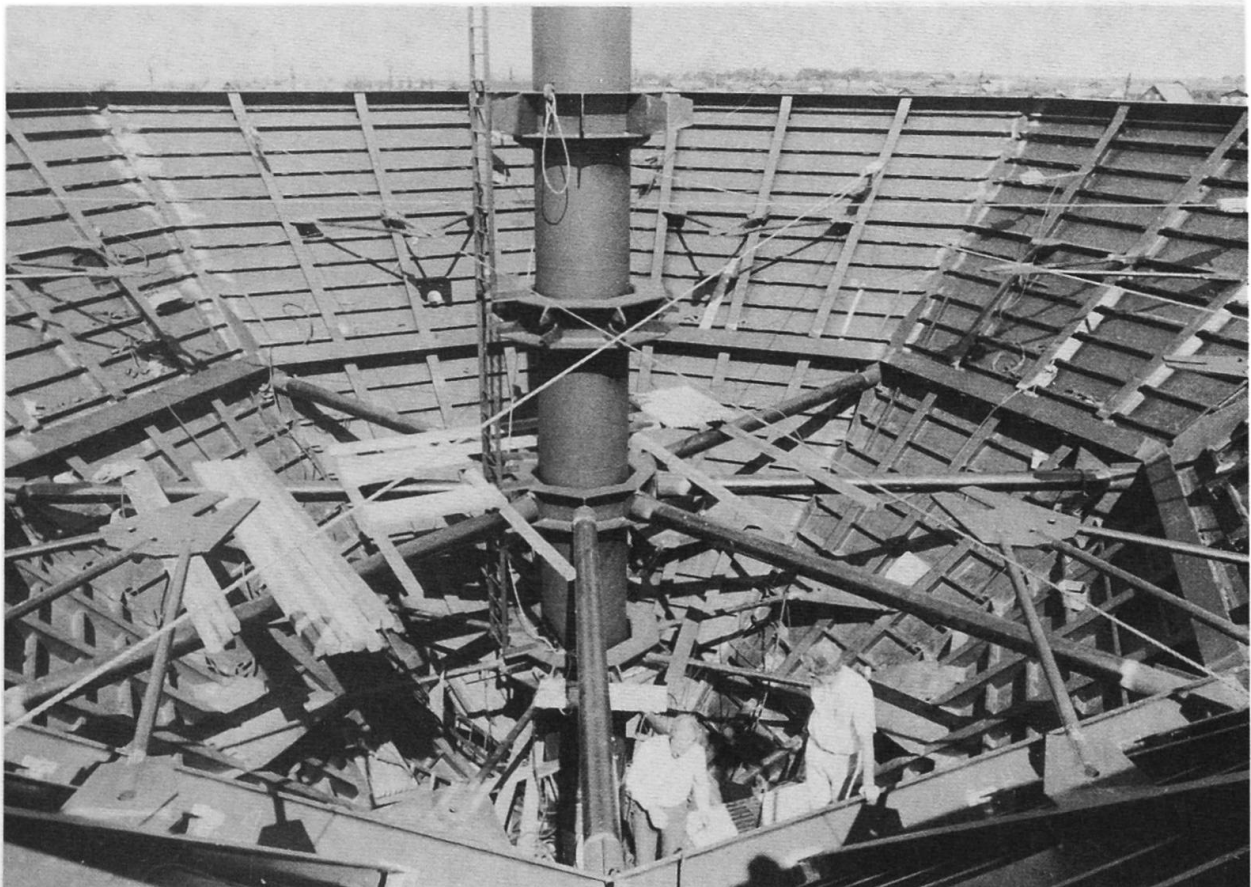

Figure 8. View of interior bracing.

The column base for the fan columns is designed for the transfer of axial tensile forces and compression forces as well as for bending moments and shear forces due to second order effects and direct wind load. Eight M36 class 8.8 anchor bolts shall be mounted from the topside of the base plate and connected to the cast in anchor system. This anchor solution allows the sideways mounting of the columns after erection of the tank on the centre column.

The centre column is connected to the tank by means of a prestressed bolted butt plate joint with bolt rows arranged at the outer boundary as well as along the circumference of the central tube.

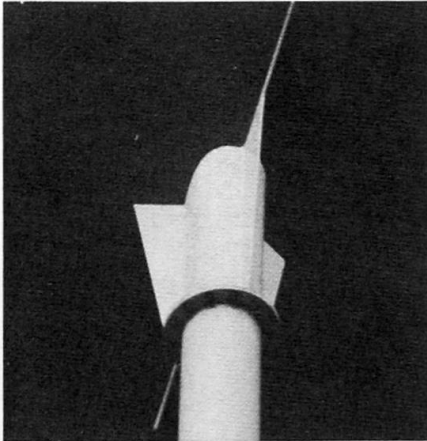

Figure 9. View of fan column top connected to socket on the tank.

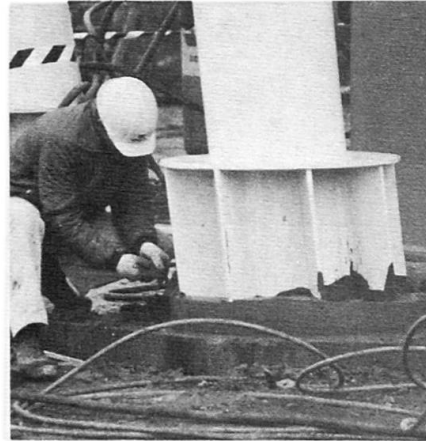

Figure 10. View of fan column base.

The centre column is restrained and anchored to the foundation by a total of 40 M 64 bolts arranged inside along the octagonal section. The local excentric bending moments introduced in case of tensile forces in the bolts that are for empty tank and max. wind load, are balanced by means of an octagonal diaphragm elevated 600 mm above the column base plate. Embecco grouting is provided to distribute the compression to the required area of the concrete foundation.

6. FABRICATION

The fabrication of the structure was carried out at M & J's workshop in Horsens. The size of the tank proper obviously requires subdivision into welded prefab sections shaped for convenient transport to the building site located in a range of only a few kilometres from the workshop. Consequently, the lower part of the tank was partitioned into the tank bottom section including the skew panel sides to a height of approx. 2 m above the bottom plate and further 16 trapezoid shaped stiffened plate panels with a max. section size of 9 x 6 m. The upper part of the tank was divided in 8 inclined trapezoid shaped prefab panels and 8 triangular shaped panels for the tank top. The centre tube was welded in full length of approx. 13 m and all support brackets for the bracing members as well as the interior ladder were mounted in the workshop.

The centre column and the tubular fan columns were shop prefabricated to permanent size. The nearly 16 m long centre column was built up in a revolving fixture allowing for automatic welding

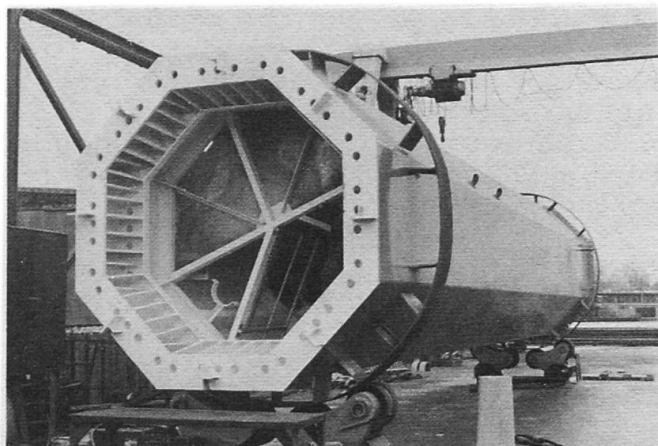

Figure 11. Centre column base

of the 8 corner butt welds in adequate positions upside down. Fitness of the top and bottom bolted joints were ascertained by adaption to template sections originally applied to installation of anchor bolts in the foundation as well as for fabrication and drilling of bolt holes in the tank bottom plate. All interior staircases, platforms and piping installations were mounted in the workshop. The centre column weighing approximately 25 t represents as such the maximum transport section.

Continuous geometric control was carried out on all prefab shop sections and at all stages of the site erection of the tank to verify deviations in geometry to be within the specified tolerances.

7. CORROSION PROTECTION

All steel material was delivered to a rust degree criteria maximum B according to DS 2019. Edges were throughout the structure rounded to a radius of 2 mm. The prefab workshop elements were sandblasted to a cleanness Sa 3 and immediately after treated with a zinksilicium primer with a dry film layer thickness of 65 micron. An intermediate layer of 25 micron inertol 49W was added on to interior surfaces of the tank and 20 micron interchlor on exterior surfaces before transport to the site. After built up of the tank on the site all weld zones were sandblasted to Sa 3 and repaired with paint identical with the shop treatment. The final painting work was carried out after cleaning of all surfaces comprising three layers of inertol W 49 to a final dry film layer thickness of 350 micron on interior surfaces and three layers of interchlor to a final layer thickness of 245 micron on exterior surfaces.

The centre column and the fan columns received the final treatment after fabrication in the workshop. Interior surfaces in the centre column were after sandblasting and priming, painted with three layers of interchlor to a final dry film layer thickness of 155 micron. The exterior surfaces of the centre column and the fan columns were after the priming painted with four layers of interchlor to a final dry film layer thickness of 245 micron.

8. SITE ERECTION

The tank was temporarily mounted on a 2 m high stub column which consisted of the template section, previously adapted during shop fabrication to the tank bottom and a template section required for the location of the anchor bolts during casting of the concrete foundation. The prefab stiffened panels were mounted in sets of 8

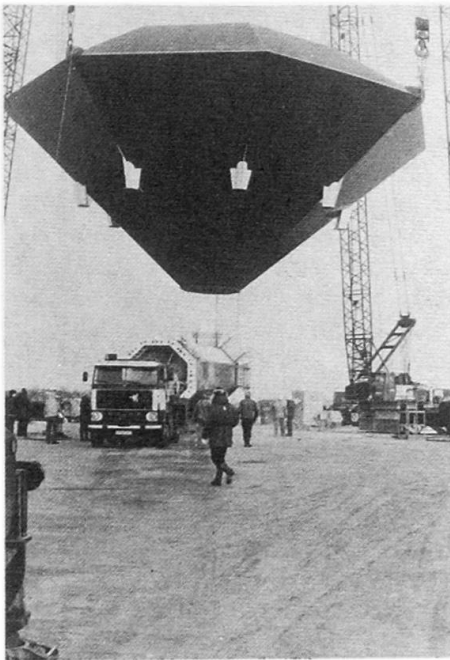

Figure 12. Water tank during hook up. Centre column on lorry.

on provisional supports provided by means of a light weight steel platform system.

All welding work followed a preplanned welding sequence to minimize distortion and residual stresses. Each section comprising 8 stiffened panels was fully finished before mounting of the next set. The lower tank part consisted to the transition level of the tank bottom section and a total of 16 panels. The tank top above the transition level consisted of 8 trapezoid shaped inclined panels and 8 triangular shaped roof panels. The temporary mounting of the tank on the stub column enabled easy access during erection and modest crane capacity was required for lifting of the panel sections.

After dismantling of the connection to the stub column the 150 t tank unit was lifted by means of four 125 t mobile cranes. The 16 m long centre column was lifted simultaneously from horizontal position by means of a wire sling suspended from the tank top through the centre tube and fastened to a padeye located in the column top. After dismantling of the stub column the centre column was lowered on to plate chocks on the foundation and the anchor bolts

After dismantling of the connection to the stub column the 150 t tank unit was lifted by means of four 125 t mobile cranes. The 16 m long centre column was lifted simultaneously from horizontal position by means of a wire sling suspended from the tank top through the centre tube and fastened to a padeye located in the column top. After dismantling of the stub column the centre column was lowered on to plate chocks on the foundation and the anchor bolts

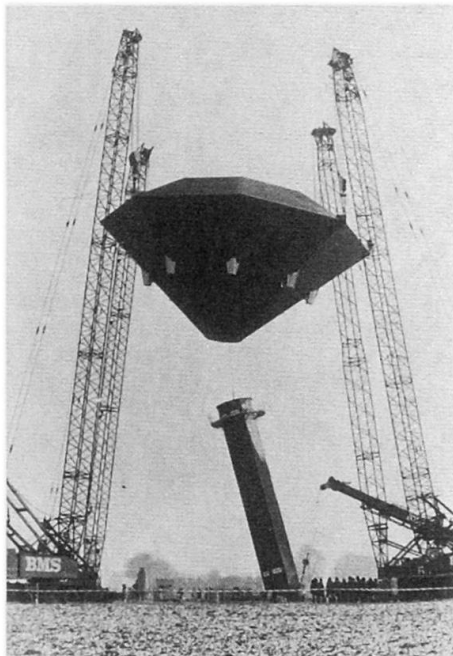

Figure 13. Water tank and centre column during hook up.

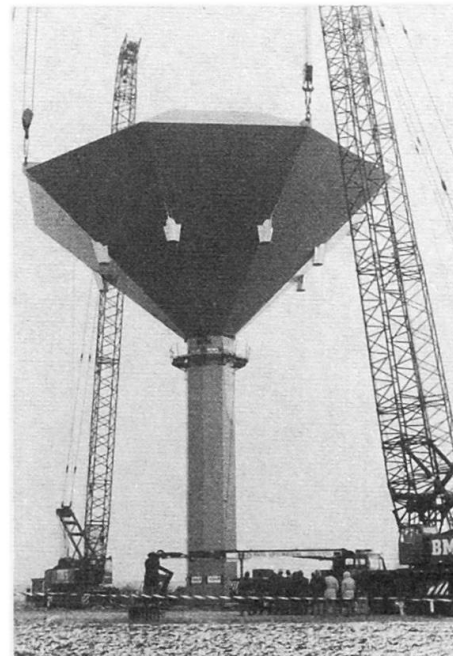

Figure 14. Water tank in position on centre column.



tightened. The tank was then lowered to the column top and the butt plate joint was connected with high tensile bolts class 10.9. Permanent controlled prestressing was carried out in two seences. The recess under the centre column base plate was grouted with embeco in two sequences to allow for removing of the support chocks. After hardening of the embeco grout all the anchor bolts were prestressed to eliminate stress variation. The whole lifting operation was scheduled to and carried out in one day the 15th of December 1983. The fan columns were moved sideway into position and after adjustment to the bolted butt plate joints at the sockets on the tank the column base was fastened with anchor bolts. After grouting with embeco of the recesses the anchor bolts class 8.8. were prestressed. The tank built up on site started in May 1983 and the erection terminated in December 1983. The tank went into service in April 1984.

9. MATERIAL CONSUMPTION

The total steel consumption for the water tower inclusive anchorbolts is 206 metric tons composed of 148.2 t for the tank proper, 24.0 t for the centre column, 29.5 t for the fan columns and 4.3 t for all the anchor bolts. The bracing members alone contribute with 18.0 t out of the total tank weight. Steel for the centre column, the tank bottom, the anchorbolts and primary stiffening beams in the tank are specified as RR St.52.3 according to DIN 17100, whereas the remaining steel material for the tank is specified as RR St.37.3. The fan columns are specified as RR St.42.3. Zones in plates and sections stressed perpendicular to the rolling direction of the material was ultrasonic tested before shop fabrication started. All bolts in erection joints are class 10.9 bolts according to DIN 267/6914, prestressed according to Dast. Guideline 010.

10. REFERENCES

Thomsen, Kjeld, Hansen, M. and Koch Nielsen, H:
2000 m³ Water Tower in Steel at Tyrsted, Denmark.
ISC Bulletin No. 16. Dec. 1983