

Zeitschrift: IABSE reports of the working commissions = Rapports des commissions de travail AIPC = IVBH Berichte der Arbeitskommissionen

Band: 8 (1971)

Rubrik: Theme III: Applications in structural design

Nutzungsbedingungen

Die ETH-Bibliothek ist die Anbieterin der digitalisierten Zeitschriften. Sie besitzt keine Urheberrechte an den Zeitschriften und ist nicht verantwortlich für deren Inhalte. Die Rechte liegen in der Regel bei den Herausgebern beziehungsweise den externen Rechteinhabern. [Siehe Rechtliche Hinweise.](#)

Conditions d'utilisation

L'ETH Library est le fournisseur des revues numérisées. Elle ne détient aucun droit d'auteur sur les revues et n'est pas responsable de leur contenu. En règle générale, les droits sont détenus par les éditeurs ou les détenteurs de droits externes. [Voir Informations légales.](#)

Terms of use

The ETH Library is the provider of the digitised journals. It does not own any copyrights to the journals and is not responsible for their content. The rights usually lie with the publishers or the external rights holders. [See Legal notice.](#)

Download PDF: 02.04.2025

ETH-Bibliothek Zürich, E-Periodica, <https://www.e-periodica.ch>

Applications of Mass Produced Steel Building Components

Applications de la fabrication en série des constructions métalliques

Anwendungen seriegelieferter Stahl-Bauteile

C. ROBERT CLAUER
P.E., Chief Product Engineer
Republic Steel Corporation
Manufacturing Division
Youngstown, Ohio

Introduction

This report covers the applications of mass produced steel building components in the construction of industrial and commercial buildings, schools, residential buildings, and storage rack buildings. There is also a section devoted to steel scaffolding and shoring. Most of the applications involve buildings constructed with industrialized building system methods. The order of treatment of each subject will be the state of the art, general examples of applications including a detailed description of one system wherever possible, main problems and future trends.

Definition of the words composing the title is offered in the interest of clarity. By "applications" is meant examples of uses. By "mass produced" we mean manufactured in large quantities as standard parts or assemblies. "Steel building" denoted a building whose principal building material is steel. For example, not only the structural frame is of steel, but also the exterior walls and roof are of steel. By "components we mean those units, parts, assemblies or elements that are shipped to the job site and erected or fastened together to form a whole building. This report then will give examples of uses of standardized steel building units, parts, or assemblies produced in high volume for field assembly or erection into steel buildings of various types.

Open web steel joists are mass produced components mentioned under pre-engineered steel buildings but not covered in detail in the report. Exhibition halls, transmission lines, television and radio towers, containers, and crane girders are not covered in this report. Only those applications in the United States about which the reporter had information are included. It is hoped that readers will advance information on other applications of mass produced steel building components about which they are knowledgeable.

Industrial and Commercial Buildings

1.0 State of the Art: Probably the largest application of mass produced steel building components is in commercial and industrial buildings. Steel buildings have been built for many years. One of the first steel building systems was the Truscon system originated in 1917. These were mainly structural steel framed, steel clad buildings. The next major impact on the industry was the Quonset hut type building developed in 1939 and used throughout World War II and immediately thereafter. Rigid frames were incorporated into steel buildings next. Butler Manufacturing Company was one of the principal exponents of this type building. These buildings are still popular today. The tapered beam or sloped beam type building followed. Tapered beams are normally made by welding flange plates to a common web using automatic welding systems. A variety of colored walls was next included in the offerings of the steel building industry. Previous to this, most steel buildings were clad with galvanized steel sheets. Factory insulated wall panels are now available. The latest advance in the industry was inaugurated in 1968 when Republic Steel brought out the concept of offering buildings in two foot increments of width and eave height. Addition of the post and beam type building to the pre-engineered building industry also came at this time, as did the inclusion of built up roofs. The electronic computer has entered the picture in the design, pricing, estimating production planning and numbering of components and shipping units. The art is ever expanding and becoming more and more sophisticated.

1.1 Examples of Applications: Three of the leading manufacturers of steel buildings in the United States are Butler Manufacturing Company of Kansas City, Missouri; Armco Steel Corporation of Middletown, Ohio; and Republic Steel Corporation of Youngstown, Ohio.

1.1.1 Butler Manufacturing Company is the largest producer of steel buildings used for industrial and commercial purposes. Butler currently manufactures four principal types of steel building systems: Widespan, Landmark, Space Grid and Triodetic.

The Widespan building system includes both rigid frame and tapered beam structural designs. The conventional rigid frame design has a roof slope of 4 in 12, the low rigid frame and modular rigid frame have roof slopes of 1 in 12. The tapered beam designs include the wedge beam frame and the width extensions both of which have a roof slope of 1 in 12. The Widespan system is the oldest Butler type and the backbone of the Butler building line.

The Landmark building system is a structural system that uses straight columns, trusses and lightweight truss purlins. It has a nearly flat roof and is adaptable to several fascia treatments. This system is frequently used for commercial buildings. Many different factory fabricated wall systems may be utilized. The webs of the trusses and truss purlins are continuous steel tubes; the chords are tee sections. Buildings are available in widths of 40 feet to 80 feet in 10 foot increments. Bay lengths are 30 feet, 40 feet and 50 feet. Ceiling heights are 10, 12, and 16 feet.

WIDESPAN BUILDING SYSTEM
Butler Manufacturing Co.

LOW RIGID FRAME



ROOF SLOPE: 1 in 12
BAY LENGTHS: 18', 20', 21', 24'

Where wide, low clear-spans are required for interior operations and exterior profile.

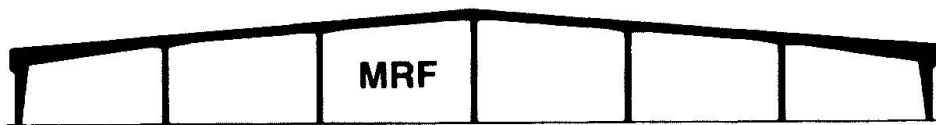

MODULAR RIGID FRAME

ROOF SLOPE: 1 in 12
BAY LENGTHS: 18', 24'
FRAME MODULES: 40', 50', 60', 70'

For economical construction of large single ridge buildings where a minimum of slender internal columns do not interfere with occupancy.



RIGID FRAME

ROOF SLOPE: 4 in 12
BAY LENGTHS: 18', 20', 21', 24'

Where the gable area is important for ventilation, overhead installation of utilities, storage or a studio ceiling effect.



WEDGE BEAM FRAME

ROOF SLOPE 1 in 12
BAY LENGTHS: 18', 20', 21', 24'

For single-span structures with a double slope roof, and a minimum of lost space at columns. Striking roof overhang is possible by moving columns inward.

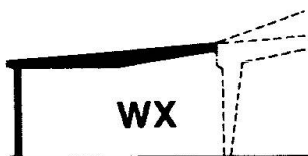

WIDTH EXTENSIONS

ROOF SLOPE 1 in 12
BAY LENGTHS: 18', 20', 21', 24'

To meet special space requirements as an extension to or expansion of an RF or LRF structural system. Multiple spans for greater width requirements.

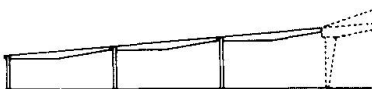

WIDTH EXTENSION IN MULTIPLE

LANDMARK BUILDING SYSTEM
Butler Manufacturing Co.

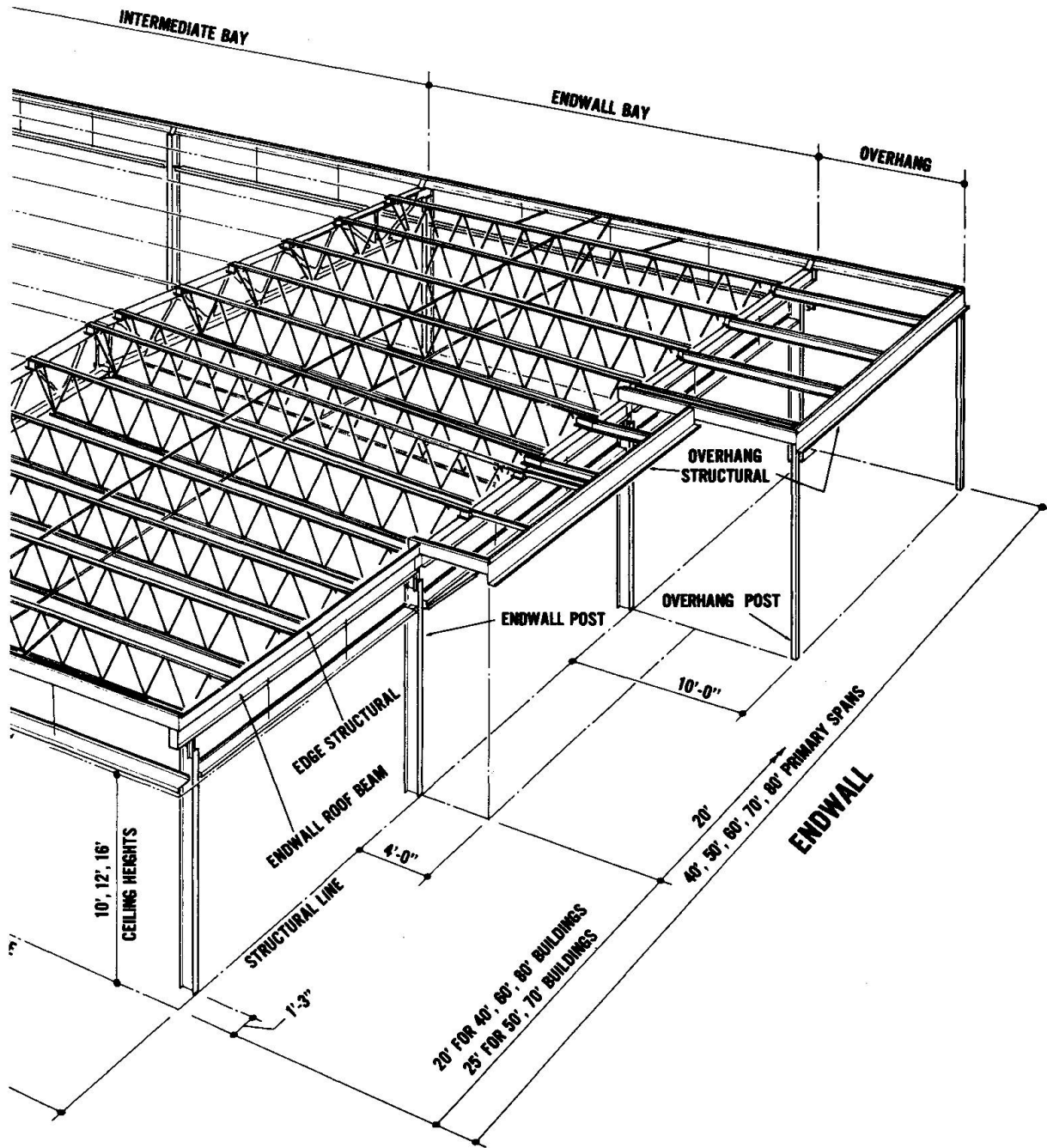

The Space Grid building system continues to be an important part of the Butler building line. Briefly, it is a modular system designed to permit maximum flexibility of partition locations and integrated with the electrical and mechanical requirements. It came into prominence at the time of the California SCSD project for one story school construction. The structure is a pre-engineered system featuring simple span Space Trusses assembled adjacent to each other to form a three dimensional structural envelope with a ceiling grid on a 5 foot module. Space Trusses are connected to Beam Trusses which are enclosed within the structural envelope. The Beam Trusses are connected to square tubular columns with fixed bases which resist lateral loads. It is a flat roof single story structural system. Horizontal framing may extend unlimited, in either direction, in 5' increments. Space Trusses span in the longitudinal directions; Beam Trusses span in the transverse direction. Ceiling heights are 9', 10', 11', 12', 14' and 16' from floor to bottom of Space Trusses. Columns are 8" square steel tubes located on longitudinal module lines. Beam Trusses are 30', 35', 40', 45', 50', 55' and 60' with a maximum depth of 31". Beams are designed to carry a 5,000 pound mechanical unit in addition to live and dead loads. Space Truss uniform depth is 35". Space Truss bays are 20', 25', 30', 35' and 40'. Space Truss Cantilevers are 2-1/2', 5', 7-1/2', 10', and 12-1/2'. This is a system of preplanned components - structurals, lighting/ceiling, heating, ventilating, cooling, walls, partitions, fascia - are all coordinated in a flexible system that allows rearrangement or expansion of space and walls re-utilizing these same components, whether exterior or interior.

SPACE GRID BUILDING SYSTEM
Butler Manufacturing Co.

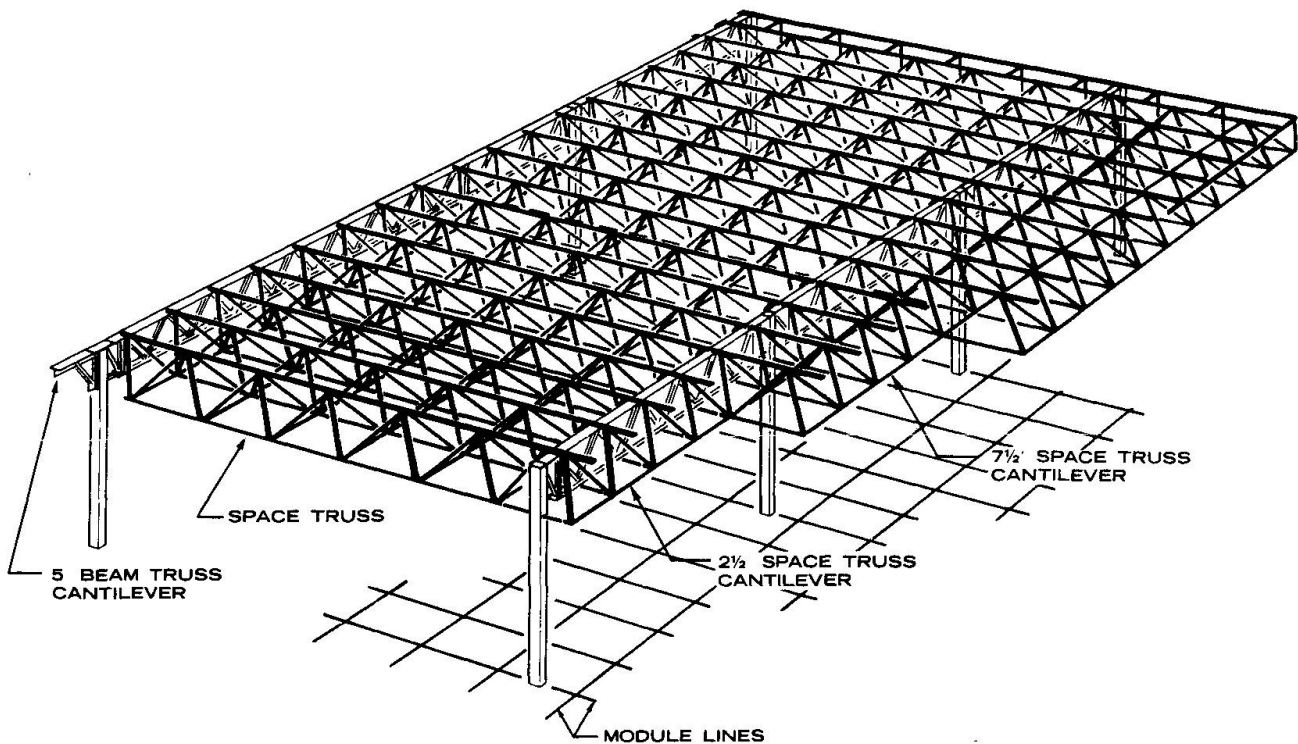

The Triodetic Building System is a reasonably new system of construction using domes, vaults and hyperbolic paraboloid design forms. The general concept appears to be similar to the type of design and construction employed by Buckminster Fuller in his geodesic dome type structures. The Triodetic structure will form both two-dimensional and three-dimensional space frames. Two-dimensional structures include cylindrical shells, toroids, conoids and hypars. In three-dimensional structures Triodetic may be used to construct structures such as slabs, braced domes, and braced barrel vaults.

TRIODETTIC BUILDING SYSTEM
Butler Manufacturing Co.



1.1.2 Armco Steel Corporation employs six different framing systems in their line of steel buildings: Self Framing, Single Slope, Tapered Beam, Rigid Frame, Truss Frame, Beam and Column.

The Self Framing system employs the stressed skin principle and is used for buildings with spans up to 32 feet. The buildings are braced horizontally, longitudinally and diagonally in a horizontal plane at the eave line.

For spans from 20 feet to 40 feet the Single Slope framing system may be used. This is a rigid frame type structural system. Wall and roof coverings are 16 inch formed steel panels.

The Tapered Beam Framing system utilizes tapered beams for the main supporting members, cold rolled formed steel purlins for the secondary structural members, and formed steel panels for walls and roof. The roof panels are standing seam type.

Armco Rigid Frame buildings are furnished in two choices of roof slope, 2 in 12 and 4 in 12. These buildings are available in either single or multiple span. All buildings are constructed using standard components. Many components are interchangeable from one framing system to another.

The Truss Frame system is used for spans up to 140 feet. Trusses are conventional Warren-type design. An unusual feature of the truss design is that both the top and bottom chords are single equal leg angles positioned on the Z-axis for symmetry. The remainder of the structural framing system and the wall and roof covering is similar to the other framing systems.

For the Beam and Column Framing system Armco uses pipe columns and structural steel beams. Purlins are cold rollformed channels. Wall and roof covering is similar to other systems. This system is frequently used for large manufacturing or warehouse buildings. One such Armco building is 386 feet wide and 400 feet long.

ARMCO BUILDING SYSTEMS
Armco Steel Corporation

Framing Systems



Self Framing
Width: 8' through 32'
Height: 8' through 14'
Slope: 2:12 and 4:12



Single Slope
Width: 20' through 40'
Height: 8' through 14'
Slope: Near flat



Tapered Beam
Width: 28' through 80'
Height: 10' through 20'
Slope: 1:24



Rigid Frame
Width: 32' through 120'
Height: 10' through 24'
Slope: 2:12 and 4:12

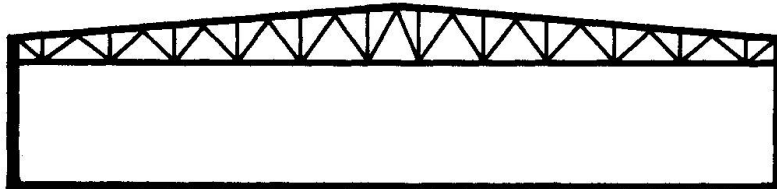

Truss Frame
Width: through 140'
Height: 12' through 40'
Slope: 1:12



Beam and Column
Width: 48' through 400'
Height: 12' through 30'

1.1.3 Republic Steel Corporation is perhaps the oldest manufacturer of steel buildings. In September 1968 Republic introduced an entirely new line of steel buildings which included three framing systems, tapered beam, truss, and post and beam. A unique feature of the Republic system was in the field of marketing; they would sell building components, not buildings. We shall see later how this has worked out.

Several other innovations included in the new Republic system. Spans from 30 feet to 140 feet are offered in two foot increments. Eave heights are available from 12 to 26 feet in two foot increments. Three standard bay lengths are 20, 24, and 25 feet. Standard designs provided for conventional built up roofs, and exposed metal roofs as an alternate. Components are designed for five different dead and live load combinations and one wind load.

All elements of the structural design were processed on the electronic computer. All parts, assemblies, and shipping packages were assigned nine digit numbers. With all the various combinations of span, height and load conditions one can realize that the numbering system is in the millions. In addition to the engineering design and detail, the computer programming includes weights of material and pricing information. A multitude of selection charts were prepared by the Product Engineering department to permit simplified ordering procedures. For example, it is possible to order an entire roof, or side of a building with one number. An entire framing system may be ordered with one number. The computer is used for production planning, inventory control and administrative planning.

Franchised dealers that had complete turnkey construction capabilities including architectural and engineering talent were carefully selected. Training programs were held for these dealers. All steel building working drawings are prepared at the dealer level rather than at the manufacturer level. This has many advantages once it becomes established. Dealers are furnished Construction Technical Manuals to enable them to design and order the proper building components.

Roof loads have been designed to meet building codes and weather conditions of the northeast portion of the United States. Roof loads are available in 25# psf, 30# psf and 40# psf live loads with a 20# psf wind load. In addition, the dead loads are 6.8# psf for an exposed metal roof and 11.2# psf for built-up roof. All systems are designed with girts that are mounted flush with the columns to facilitate flush wall type construction no matter what type of sidewall is used. All designed systems utilize structural connections with a minimum amount of parts to be field attached. Accessory options engineered for compatibility are broad in scope and have universal application regardless of the basic structural system. Steel wall panels with blanket insulation, shop fabricated insulated panels, conventional brick, block and wood sidings can also be used with the basic steel structure. Doors, windows, store fronts, trim, ventilators, facades, fascia systems, attached and free-standing canopies, covered walkways, interior mezzanines all combine to provide a product offering that provides extreme flexibility.

Republic Tapered Beam Buildings are available with a sloping roof 1" in 12", or with a flat roof. Standard buildings are available in clear spans from 30' to 80' in 2' increments. Eave heights from 10' to 26' in 2' increments. The sloping roof design is available in exposed metal or built-up roof only. Parallel flanged columns used throughout the systems are positioned so the center of the endwall is column free, permitting openings in the center of the building. Girts are mounted flush with columns to facilitate mounting of exterior and interior wall paneling. Utilization of the diaphragm action of the roof and walls eliminates much bracing.

TAPERED BEAM SYSTEM
Republic Steel Corp.

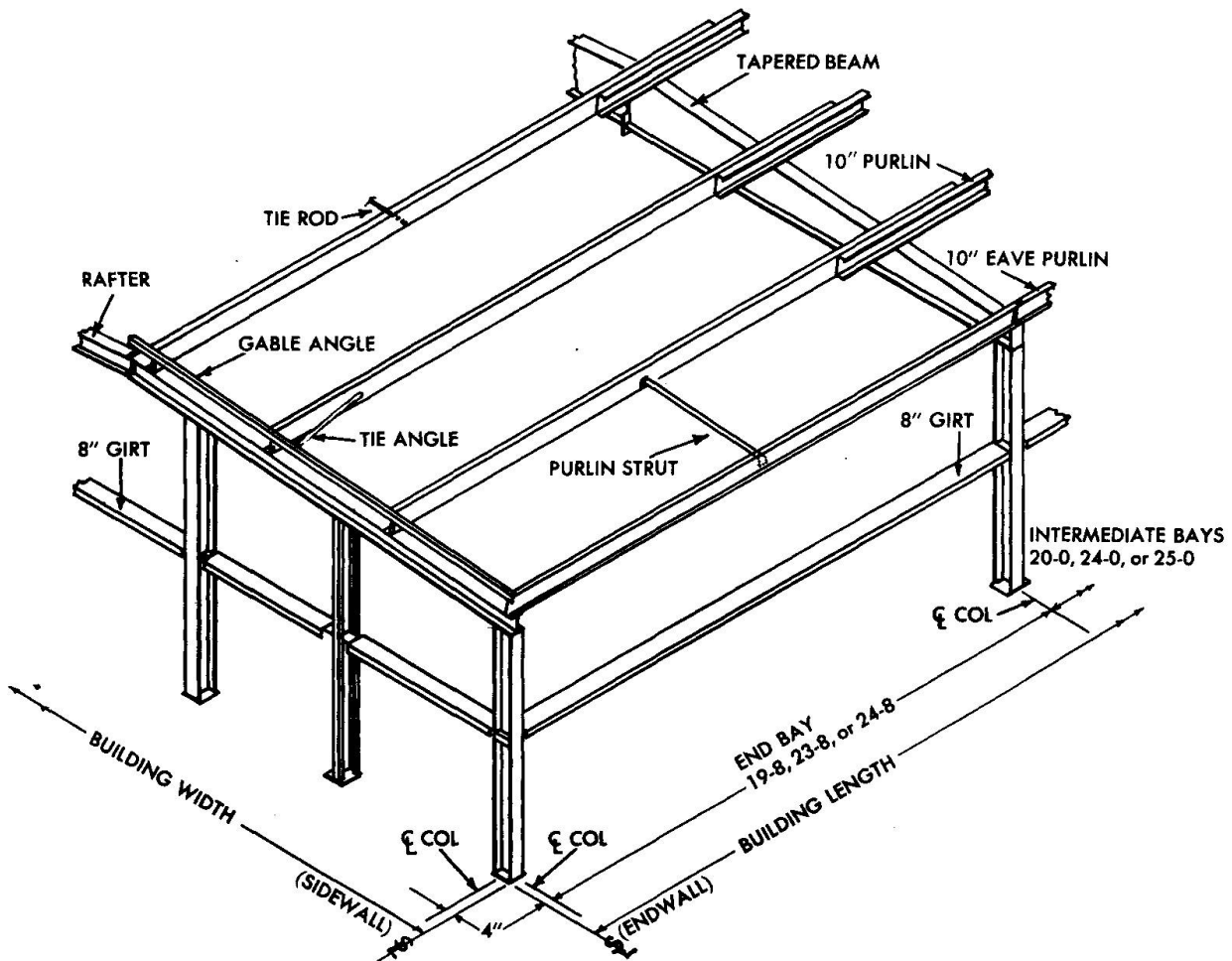

Republic Truss Buildings are available with clear spans from 30 to 140 feet in 2-foot increments. Either parallel chord or sloped chord trusses are available. Eave heights are 14 to 26 feet in 2-foot increments. Bay spacings 20', 24' and 25' are available and can be combined to yield a range of floor dimensions unlimited in scope. Parallel flange columns used throughout the system and positioned so the center of the end wall is column free. This feature facilitates mounting of overhead or double man doors at the center. Connections at columns provide extra rigidity because connections are made at top and side instead of in a single plane. Girts are mounted flush with columns to facilitate mounting of exterior and interior wall paneling. Republic Steel diaphragm action of roof and walls eliminates the need for unsightly bracing.

TRUSS BUILDING SYSTEM
Republic Steel Corp.

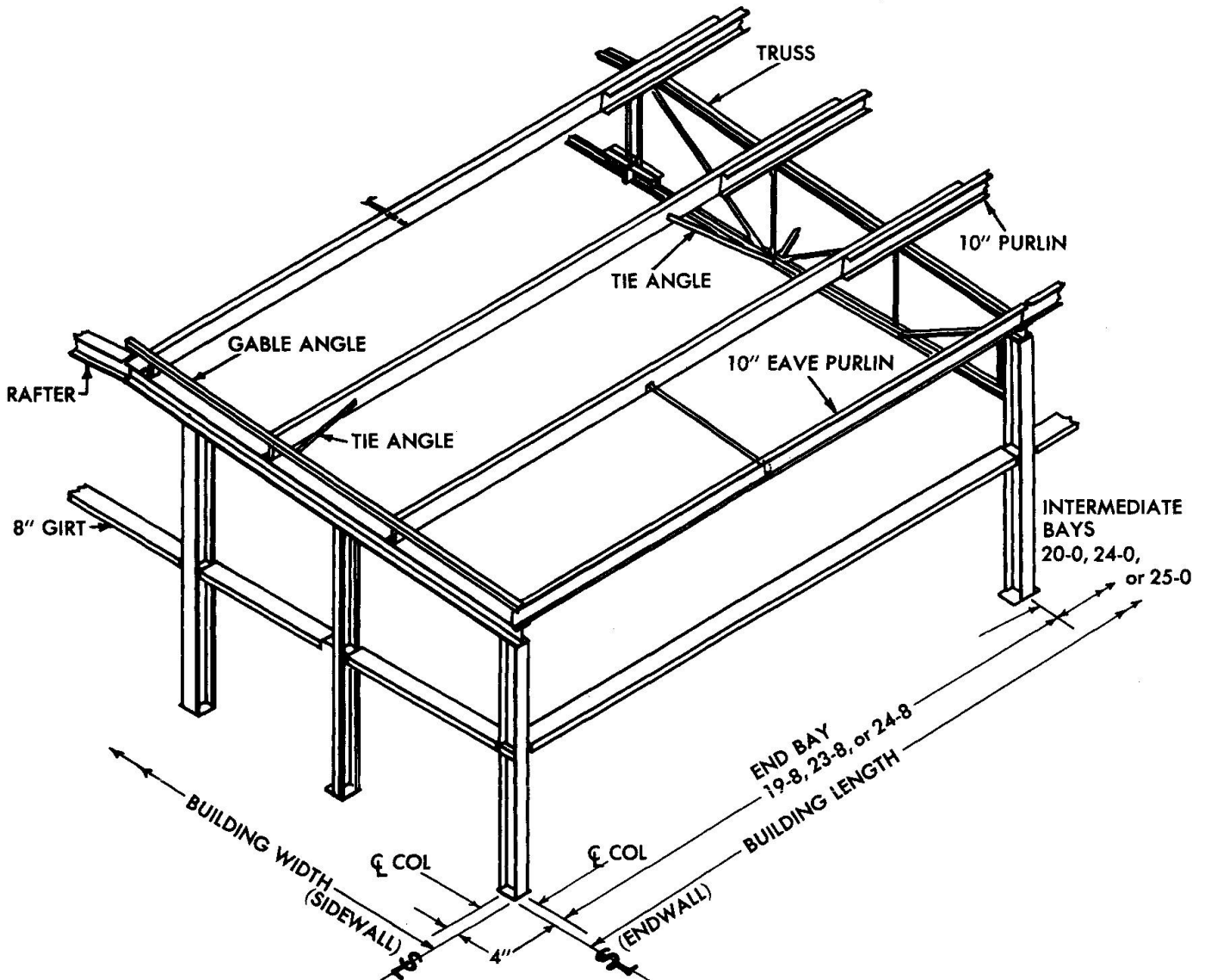

The single-story post and beam type buildings are designed on a 40' x 40', 40' x 50' and a 40' x 60' grid spacing. The clear heights are 12' to 26' in 2' increments. Minimum building size is 120' x 120'. Roof loads are the same as the truss and tapered beam buildings with an additional 3# psf allowed for sprinkler and mechanical loads. Roof and wall panels are made available in galvanized or colored finishes of ten standard colors. Post & Beam two-story buildings are pre-engineered in basic modules of 40' x 40' bays on the second floor and 20' x 20' on the first floor. Roof loads are the same as on the other systems. Clear heights range from 24' to 26' with expandable second floor spacings of 8', 10' or 12' clear heights. Republic's "O-T" open web joists are used throughout the Post & Beam system as secondary framing members to obtain strength and ease of installation.

POST AND BEAM SYSTEM
Republic Steel Corp.

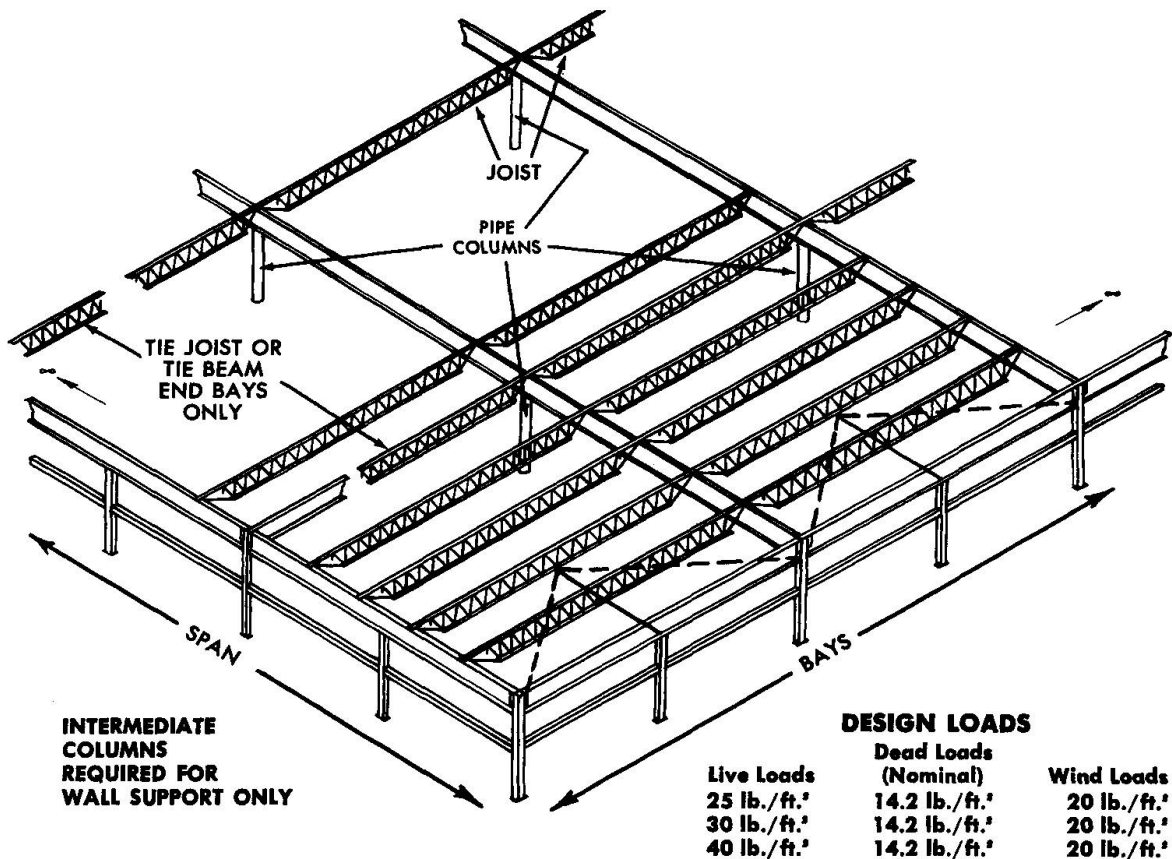

By means of a computer program it is possible to determine the price of a Republic Building in a relatively short time and with a minimum of effort. The following is a brief description of the Program and its limitations and capabilities.

The Republic Steel Building Technical Manual and Pricing Manual, consisting of approximately 80,000 numbers, have been placed in Computer Storage. A Program has been written using IBM CALL/360 BASIC SYSTEM which extracts the various numbers from the Computer Storage, selects the proper number, and then prints out a complete Republic Steel Building order form with weight and prices. The following list describes some of the current limitations of the Program:

- (1) This program assumes length of the building in multiples of 20', 24', or 25' bays. Presently, it does not take mixed bays.
- (2) For 2-span buildings, both spans must be equal and total width is equal to width of both spans. For 3-span building exterior spans must be 2@ 24' or 2@ 48' or 2@ 72'. Mixed spans are not permissible and width should be in 2' increments.
- (3) Eave heights limitations for all types of buildings are as described in the Technical Manual of Republic Steel Buildings. These limitations are not strictly followed.
- (4) All load conditions are accepted as described in the Technical Manual.

1.2 Main Problems: Training contractors, builders and architects, engineers, and regulatory people to use and appraise the building systems properly. Building codes in many cases are too restrictive. Requiring a three hour fire rating in certain fire zones is a real problem. Breaking down general resistance to the thought of "tin buildings".

1.3 Future Trends: Design trends are toward more sophistication which will permit even more mass production of components, simpler erection, less field labor. High strength steel is already employed by most manufacturers for structural elements. Textured steel panels are already being used somewhat for wall panels. Color is here to stay. Wall and roof panels are currently produced from prepainted steel coils over rolling systems that do not damage the painted surfaces. The trend is toward better buildings pleasing in appearance. Computerization of all elements of the design, engineering, manufacture, shipping, accounting, and erection is here and increasing. This is a growing business. Contractors recognize that we can no longer afford to erect buildings one block at a time. Future trends are toward higher eave heights and two story buildings. More and more steel buildings will be sold. Butler reports having produced over one hundred thousand buildings and no let up in sight.

School Buildings

2.0 The state of the art: The practice of using steel buildings for schools has not significantly advanced since the impetus given in 1961 by the California School Construction Systems Development Project previously reported at the 1968 Congress. Improvements have been made in some systems but no major changes. Steel buildings are becoming more readily accepted for school construction than before and more steel buildings are being used.

2.1 Applications of steel buildings for schools: Several schools have been built using the Butler Space Grid System, the Armco System, the Republic System and others.

The Butler Space Grid System was developed in 1961 for the California School Construction Systems Development Project improvements and extensions have been made in the system. It continues to be very popular for use in schools as well as other applications.

Butler's type A school building provides a class room unit containing two classrooms each with 896 square feet of space. The type B school building provides a classroom unit having two classrooms each with 952 square feet of space.

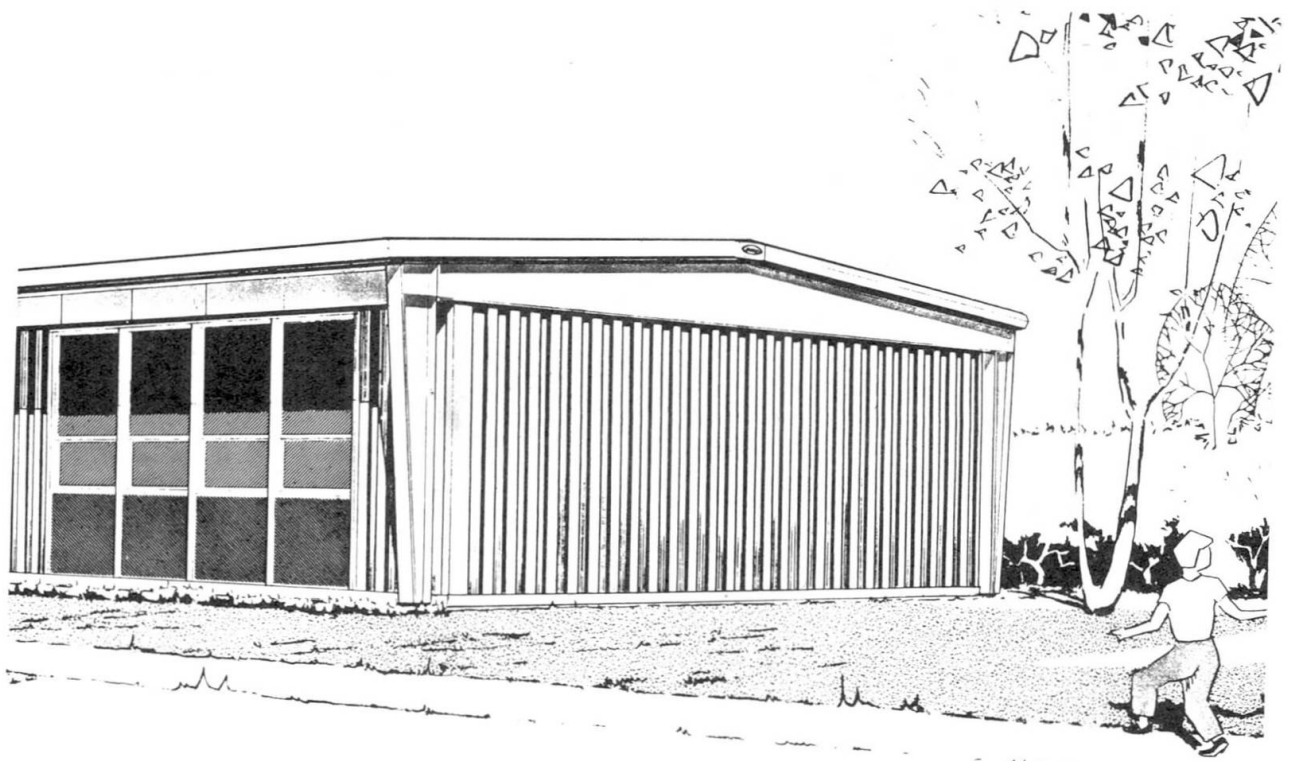

Type A

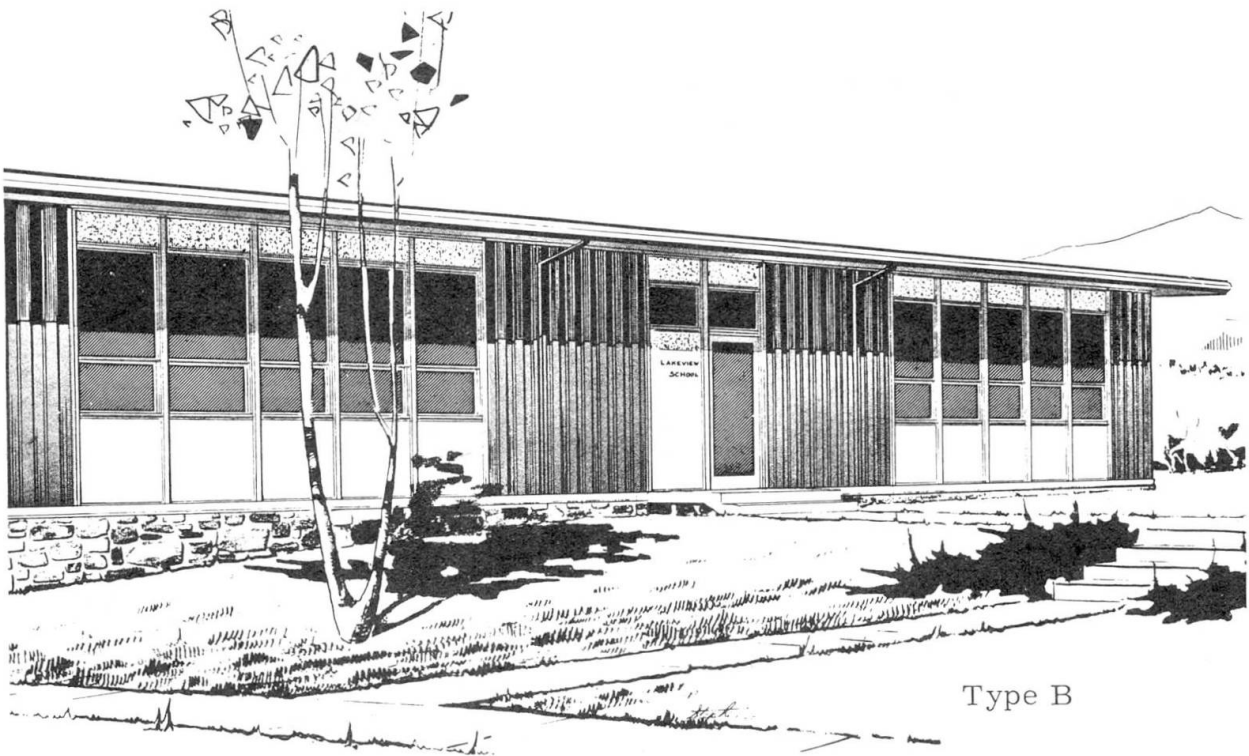

Butler has applied the Triodetic Building System to an unusual 55,943 square foot elementary school in Saginaw, Michigan. Roofs of the buildings appear to be a cluster of mammoth stars on both sides of the Triodetic dome. Each star is made up of five hyperbolic paraboloid geometric shapes. The Triodetic dome shelters the playground area of the school.

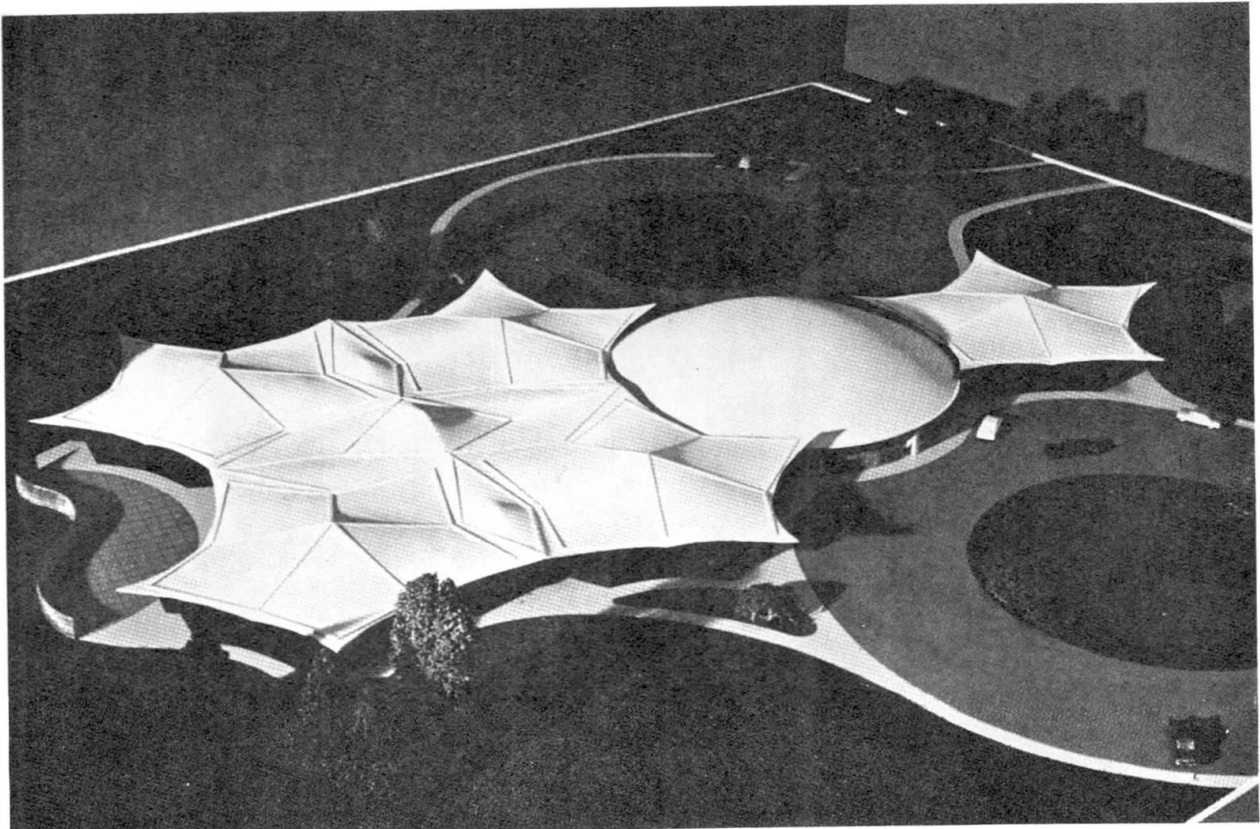

Armco Steel Corporation has furnished Steel Buildings for school gymnasiums and auditoriums. A rigid frame type building with 22 ft. eave height and clear span of 90 feet has been used for this purpose. Other school gymnasiums have been furnished with a clear span of 70 feet and an eave height of 16 feet.

A 40 foot span rigid frame building has also been furnished by Armco for classroom use.

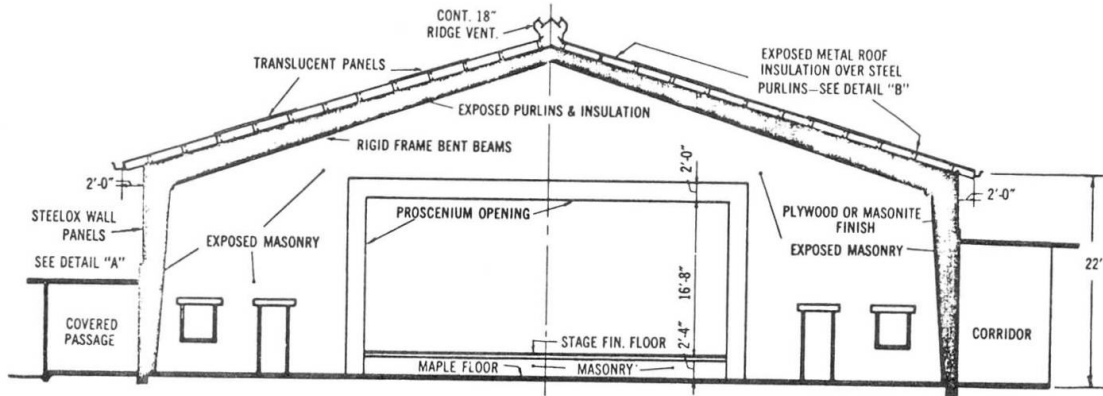

Cross Section—Gymnasium-Auditorium

In addition to other steel buildings furnished for school use, Republic Steel Corporation furnished a complex of six Tapered Beam type buildings for interim classrooms at the College of Lake County, Deerfield, Illinois. Each building is 80' x 120' constructed on a concrete slab foundation. The entire project was completed in 90 days.

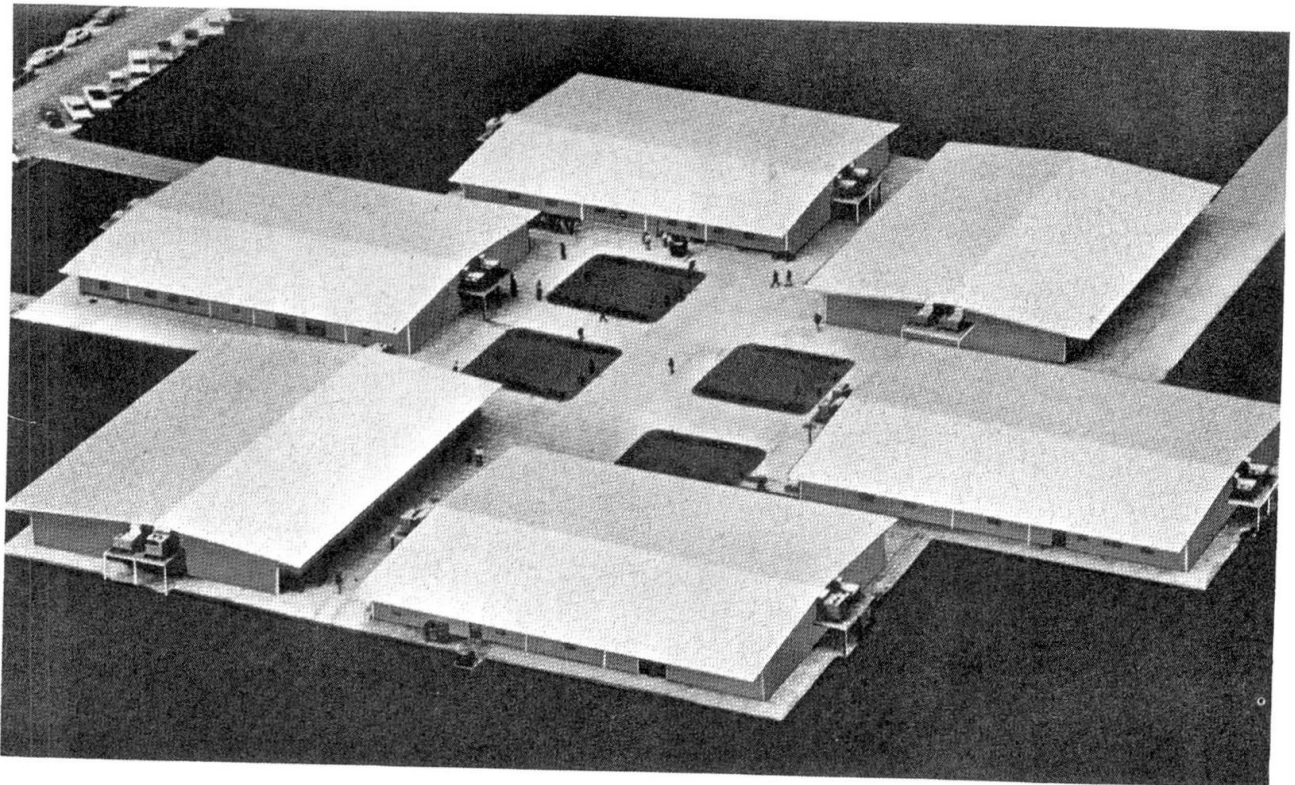

An adaptation of Mobile Homes to schools has been done successfully. Two mobile home units 12' wide by 40' long with one side on each, when assembled side by side provide a very successful classroom 24' by 40'. Steel is used extensively for structural framing and exclusively for underframes. Galvanized sheet steel is used for roofs, heating and ventilating ducts. Steel is also used for some exterior panels.

2.2 Main Problems: One large problem is overcoming the reluctance of school architects to employ steel buildings into their designs. Usually this is done only at the insistence of the school board or as a method of saving the project after initial bids have overrun the estimate substantially.

Another large problem at the present is the high cost of mortgage money necessary to finance construction. School taxes and taxes in general are high; citizens are reluctant to vote for additional taxes or bond issues to finance new school construction.

2.3 Future Trends: The high cost of field labor is forcing architects and contractors into using building systems that offer a minimum of field labor. This indicates that more and more steel buildings will be included in designs for schools.

Residential Buildings

3.0 State of the Art: In the United States there has been a marked increase in activity and the art has advanced considerably during this past year due to the effect of "Operation Breakthrough", the current housing project of the United States Government Department of Housing and Urban Development. I believe I can safely predict that during the next year there will be substantial progress in industrialized residential systems building as a result of "Operation Breakthrough".

Particularly in the residential field, there is strong emphasis and a trend toward industrialized building instead of conventional building methods.

The conventional building process of today can be described as the assembly, at the job site, of many different and often incompatible parts which serve different functions and which generally have to be adapted or modified in order to fit together. The actual process of assembly is carried out by workmen of various trades who work for various sub-contractors and who perform work which can be complex and critical in circumstances which are often dangerous, uncomfortable and exposed to the vagaries of the weather. And finally the entire construction schedule is affected by the delivery of materials, availability of labor, and the weather.

The essential purpose behind the concept of "industrialized building" is to introduce into the construction field some of the techniques and thinking which have enabled other industries to increase their productivity to such a high degree. The main emphasis within this approach is placed upon the development of integrated, compatible components which may be assembled in the field with the minimum of time and effort. It is anticipated that industrialization will bring mass-production, reduced labor costs, reduced time of construction at the job, and better control of quality to the building industry.

3.1 Examples of Applications: The United States Steel Corporation has a building system for residential construction. United States Steel's approach to systems building in steel is through volumetric hotel/motel room units. These are inserted into a structural building frame at the job site. "Flagship", a major convention hotel in the Walt Disney World recreation center at Orlando, Florida, will use this system. The main building will be a 10-story high-rise structure featuring a spectacular open-mall lobby longer than a football field, with an 80-foot ceiling. This hotel will use 808 pre-fabricated hotel/motel room units. This is a good example of the application of standard pre-fabricated steel units to a customer structure.

The light steel-framed hotel/motel room unit measures 29' x 14'4" and is built around a structural frame consisting of rigidly welded tubular posts, floor and ceiling beams. Galvanized steel deck 20 gage (1-1/2" deep) provides strong, light weight structural flooring capable of supporting a live load over 100 psf. The deck is stud welded to the floor beams. The entire underside is then sprayed with sound absorbing fire-proofing. The subfloor consists of 1/2" mastic. The bathroom and wardrobe area is then covered with resilient vinyl sheet flooring. Carpet and padding cover all other areas.

Light gage, 2-1/2" galvanized steel studs with gypsum board on both sides provide light weight and economical wall construction. The walls provide the required surface finish, for protection and sound separation.

The ceiling is supported by prepainted steel tube members which span the width of the room. The ceiling material is 5/8" gypsum board covered with 1/8" textured spray-on paint. A utility chase has been placed on the corridor side so that all plumbing, ductwork and electrical connections may be plugged in from the outside. By providing a cast gypsum fire stop at each floor level, after vertical piping and ducts are installed, the pipe chase becomes a "Mechanical Closet" and does not require fire-rated walls as does the conventional vertical pipe shaft. The room units will be assembled in an on-site production facility. Each unit will roll off the production line complete with carpets, drapes, furniture, etc. Mechanical and electrical installations will be factory completed so that only a simple nest-in type of erection will be required in the field.

HOTEL/MOTEL ROOM UNIT
United States Steel Corporation

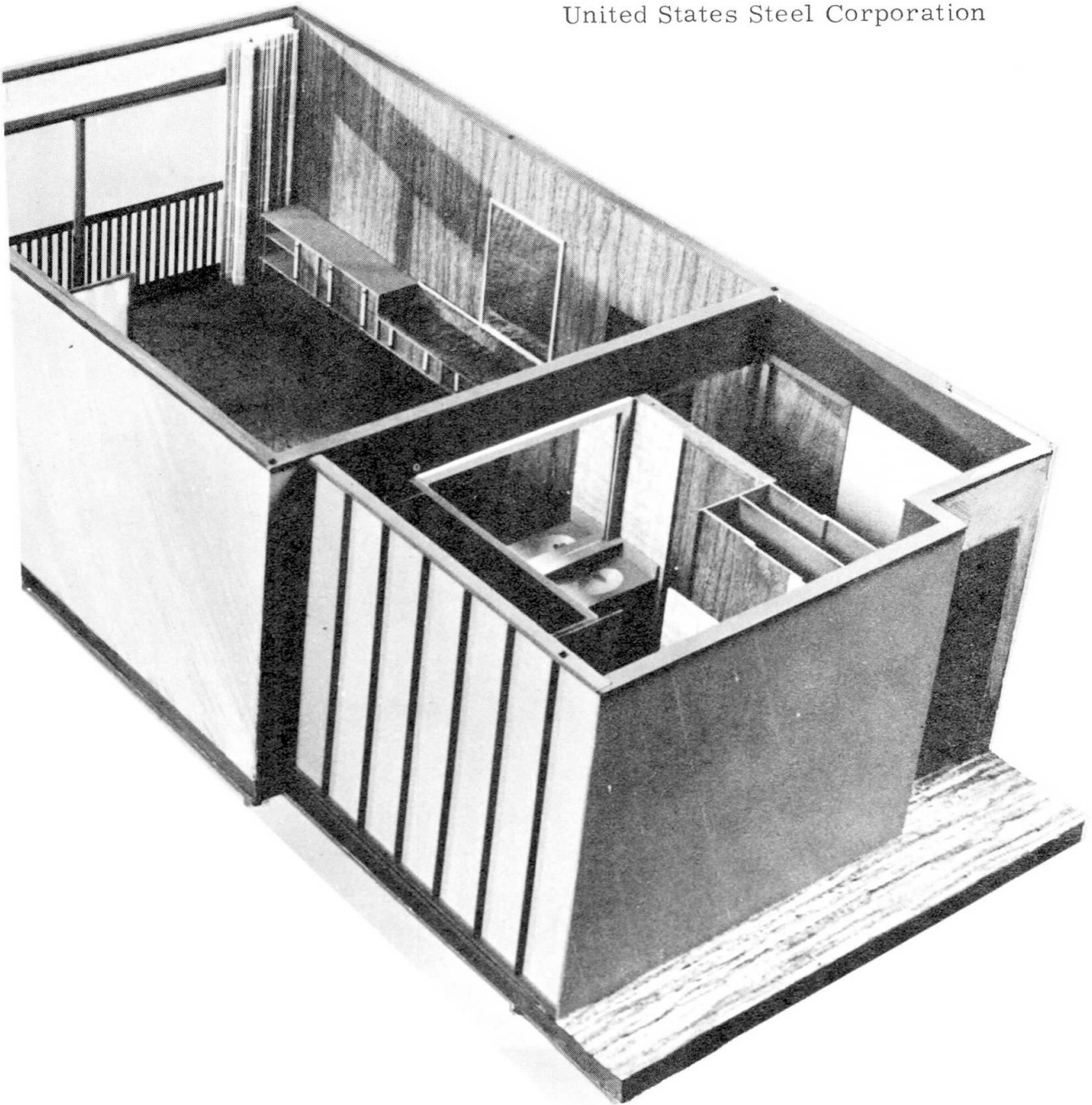

Republic Steel Corporation, a long time producer of building products, will soon enter the field of residential building systems with a single family detached residence. The principal material used in the residence construction will be steel. The residence has been designed for high volume industrial production yet it is flexible in appearance and arrangement.

The system has been designed to provide privacy and individual home ownership, both highly desirable marketing features. Elimination of all on site skilled and manufacturing labor, using only simple unskilled assembly labor is the principal objective. Building components such as wall and floor panels, suitable for mass production are key features of the design.

RESIDENTIAL BUILDING SYSTEM
Republic Steel Corporation

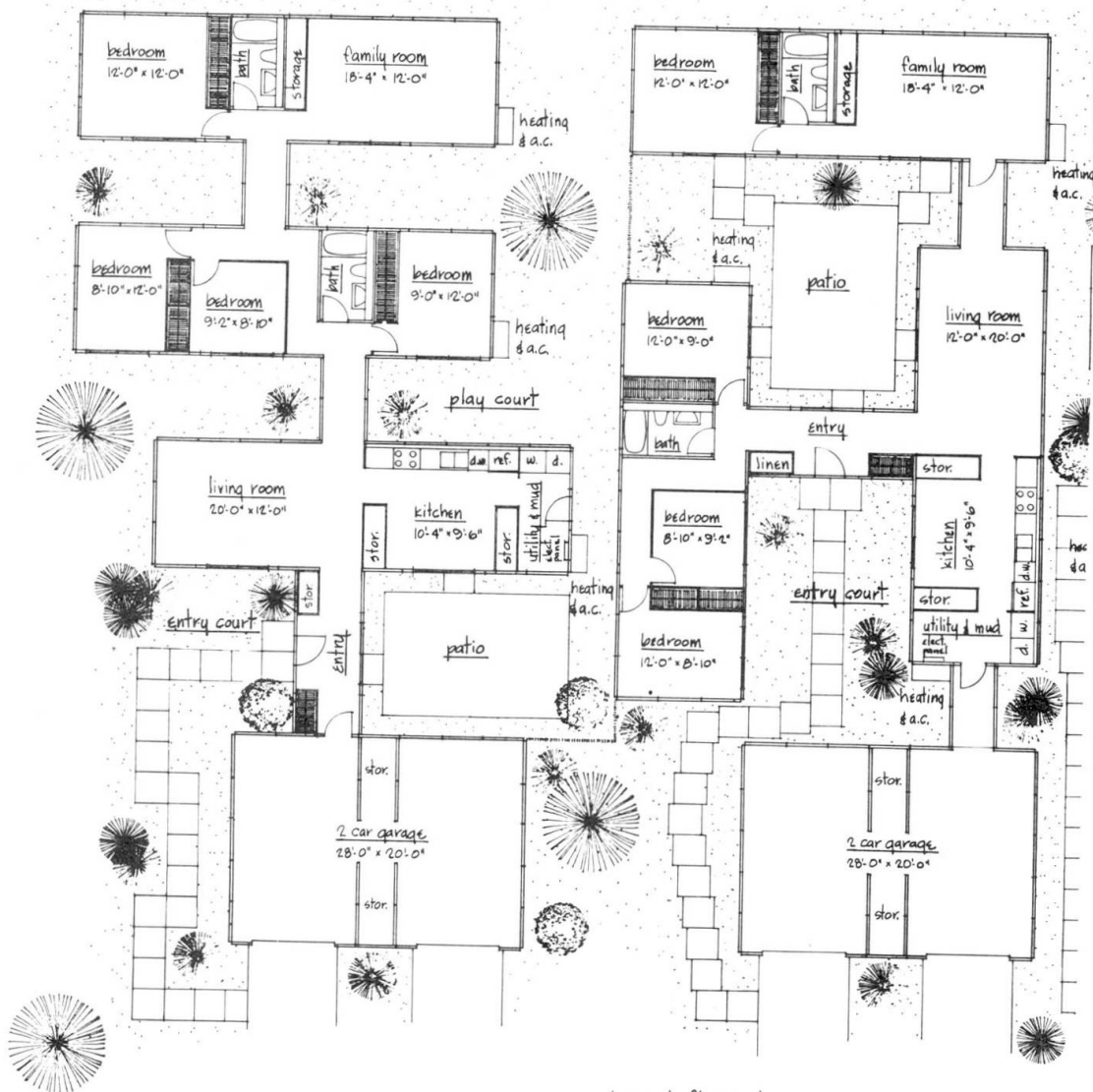

typical floor plans
scale: 1/8" = 1'-0"

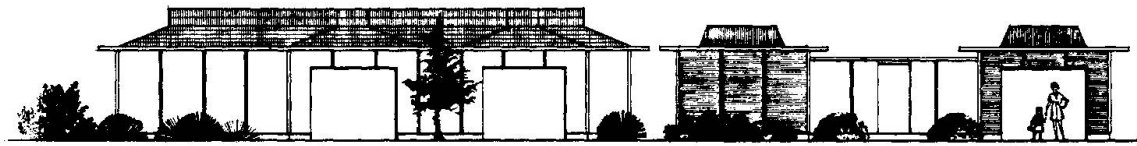

typical elevations
 scale: 1/8" = 1'-0"

A grade beam runs around the perimeter of each module. The grade beam supports the floor framing and floor panels as well as the wall panels. The roof panels are supported by the side walls. This module is 12 feet wide by 40 feet long and 8 feet high.

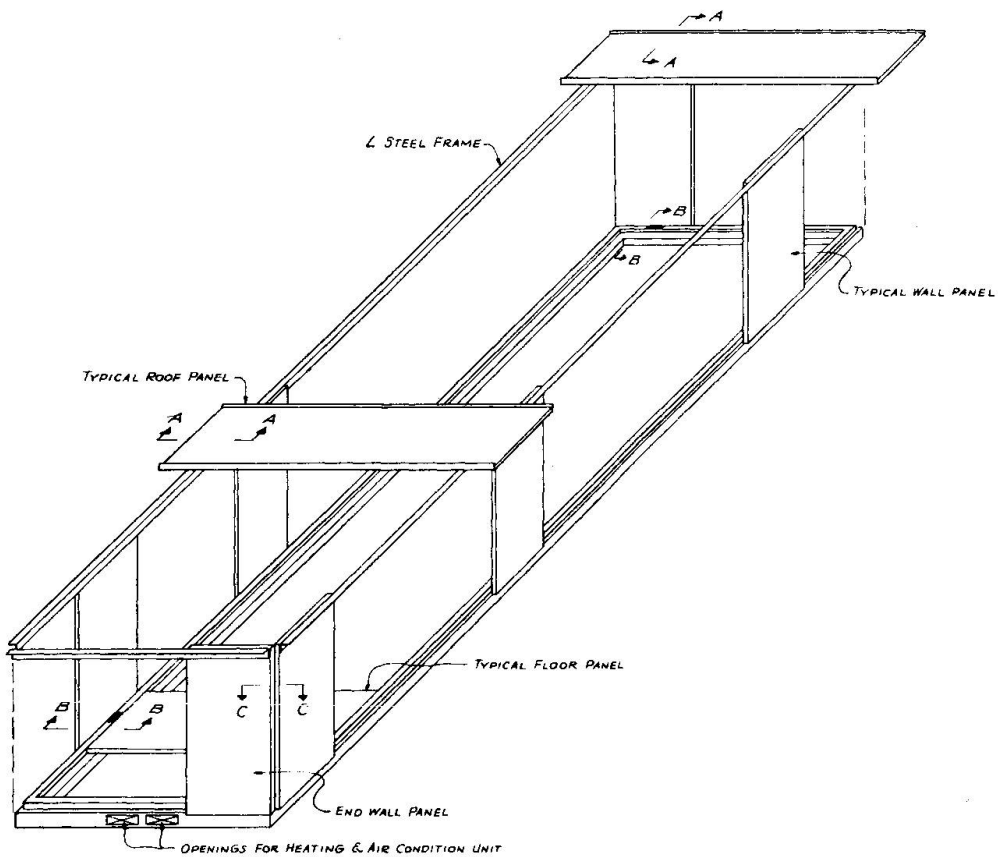

OBLIQUE VIEW OF MODULE

The floor, wall and roof panels are structural panels having a steel facing on both sides of a foam and insulated paper honeycomb core providing structural and highly efficient thermal and acoustical advantages. The steel grade beam functions as duct for a central air conditioning and heating system. The use of steel grade beam for air conditioning and heating is highly efficient and provides positive controllable comfort of occupants of each module. Each 12' x 40' module has its own Heating and Air Conditioning System with zone control.

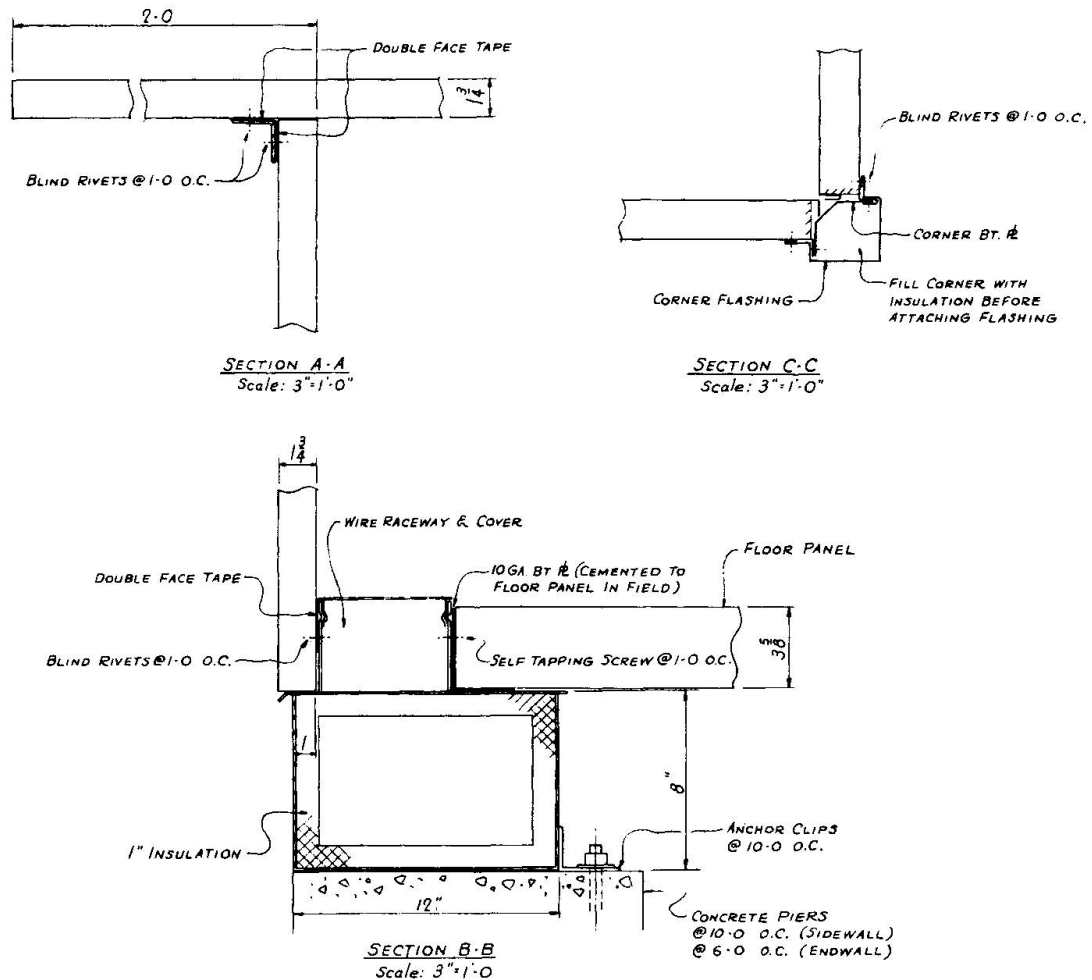

The use of wiring raceways on the inside perimeter of each of the modules simplifies the installation of prefabricated house wiring. Raceways are designed to permit easy access to wiring and electrical outlets. The electrical power distribution system design allows complete factory assembly of the house wiring system including wiring harness, outlets, switches, and panel boards. Innovative power distribution ideas are used in the switching of indoor and outdoor lighting through selected placement of floor mounted foot actuated switches. The basic lighting concept develops a soft residential type atmosphere. Swag lighting fixtures are a basic part of the lighting design. Wall mounted fixtures at floor level will wash the walls with light from bottom to top.

Cove lights will be provided over all patio doors. Kitchen, Laundry and bathroom lighting are included in those subsystems.

Another key feature of the Republic System involves subsystems independently manufactured and assembled separately from the structure, installed into the structure and ready to operate when water, drainage, and electric lines are connected. This applies particularly to the kitchen and laundry and bathroom subsystems.

The total factory produced bathroom is designed as a modular component subsystem. This total bathroom package includes the floor, walls, plumbing fixtures, fittings, drain waste and vent system, water system, lighting system, exhaust fan and its own hot water heater. The installation and hookup of this bathroom system will be accomplished on the job with unskilled labor. The kitchen and laundry subsystem includes all appliances plus plumbing, wiring, lighting and hot water heater. The installation of a completely fabricated kitchen and laundry module can be accomplished with readily accessible lifting equipment. After being installed by relatively unskilled, on-site labor, the kitchen-laundry subsystem is ready to function after making three pre-arranged connections: water, sewer, and electric.

KITCHEN SUBSYSTEM The Tappan Company

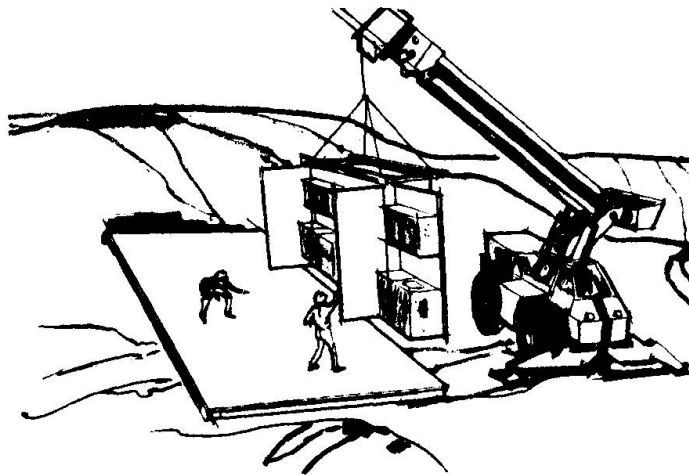

3.2 Main problems: The main problems that must be overcome for success in industrialized housing are the constraints presented by local building codes, zoning restrictions, local ordinances and resistance of labor unions to systems that reduce or eliminate the need for skilled labor at the job site. In the United States the Department of Housing and Urban Development promises to eliminate these constraints for those companies participating in "Operation Breakthrough". Republic Steel Corporation is one of those companies.

3.3 Future trends: Indications are that the future trends in residential housing is toward industrialization. The large volume of housing needed in the United States is 2.6 million units per year for 10 years which can only be met by systems that are geared for mass production.

Storage Rack Buildings

4.0 State of the Art: Using steel storage racks as the primary structural support for the roof framing system and the wall framing system was conceived nearly ten years ago. A patent on a system of this type was assigned to the Pet Milk Company of St. Louis, Missouri. Storage Rack buildings are frequently used for cold storage purposes and warehouses for textiles and other materials.

4.1 Examples of Applications: Several manufacturers have been producing components for rack buildings for several years. An example of one of the first rack buildings is the Pet Milk warehouse at Frankfort, Michigan. This structure is 130' x 132' with a 20' eave height. The racks that support the roof are the "drive in" type used with lift trucks. This is a cold storage warehouse.

For this project the racks were erected first and then the exterior walls and roof framing followed. Attachment of insulated panels to roof and side-walls completed the installation. It is estimated that this method of construction saved 33% to 50% of the cost of conventional construction.



The racks which hold the goods and support the roof, are assembled and lagged to the floor. Here, crew adds bracing over main aisle.

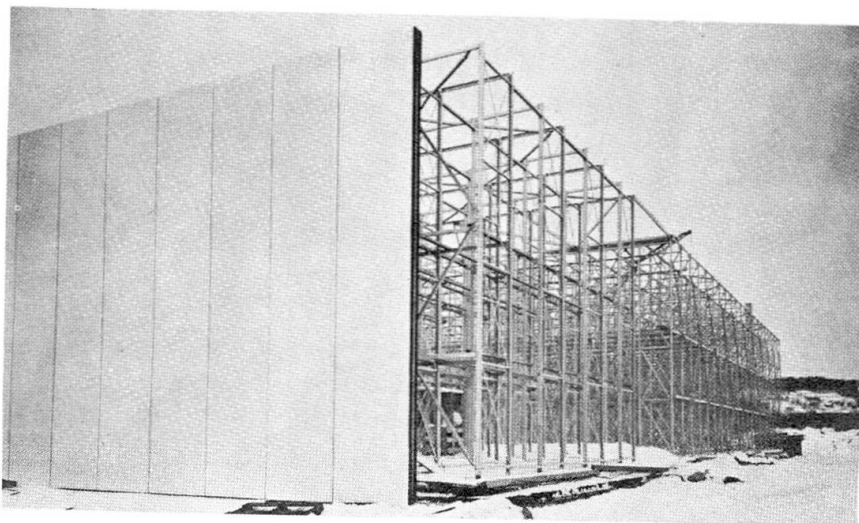

Pre-fabricated wall panels are put in place and bolted together.

The roof panels are placed on and joined to the racks, then covered with a built-up roof.

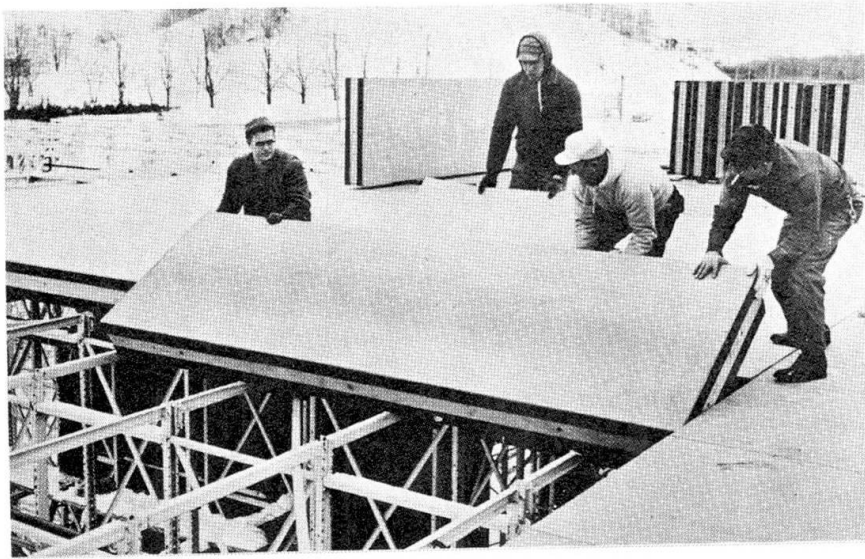

Another example of a rack building is the Potato Service Company building at Presque Isle, Maine. The racks supporting this building are also "drive-in" type. Speed of erection of the total building is another feature of rack buildings.

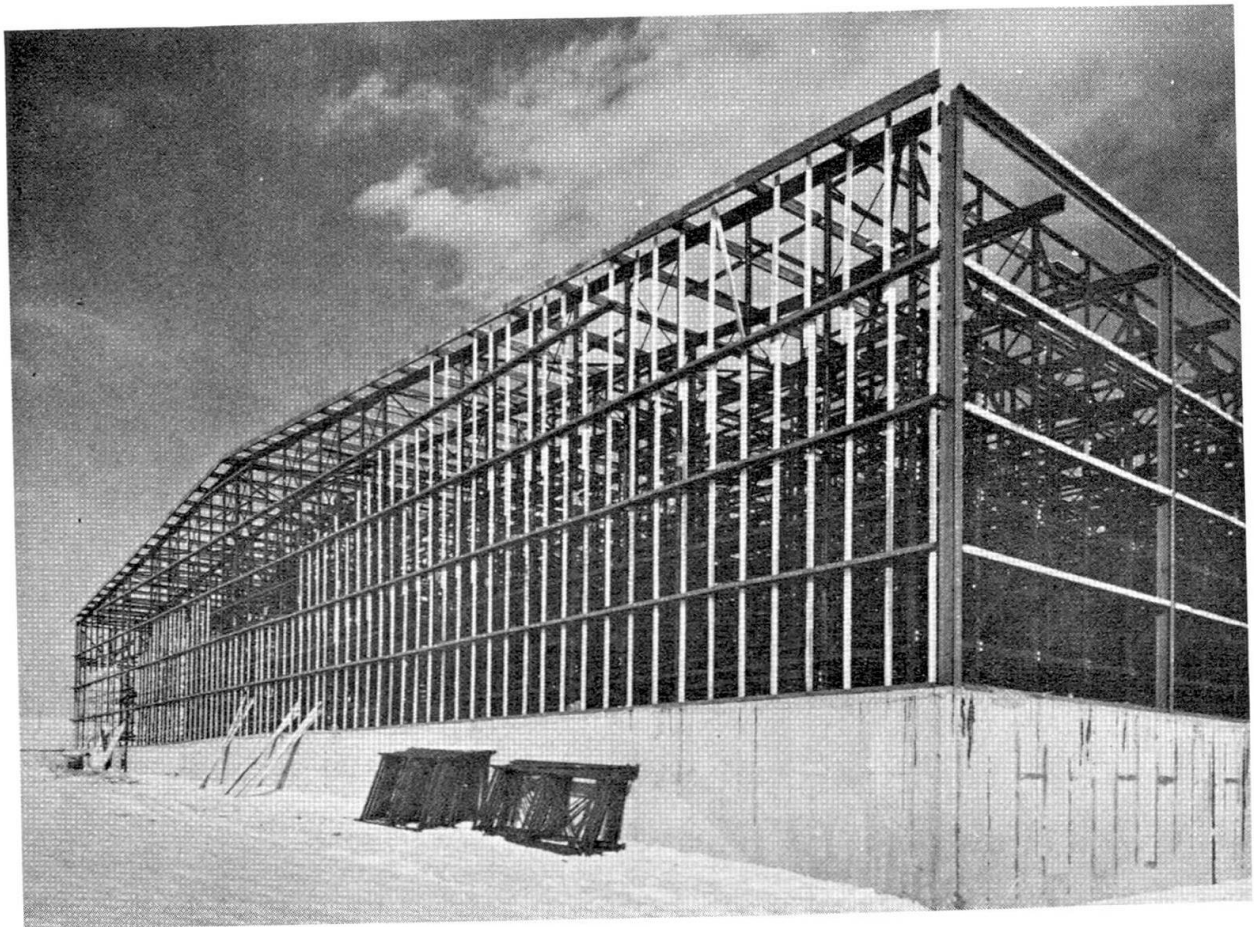

Republic Steel Corporation are producers of complete rack buildings including steel framing and steel panels for sides and roof.

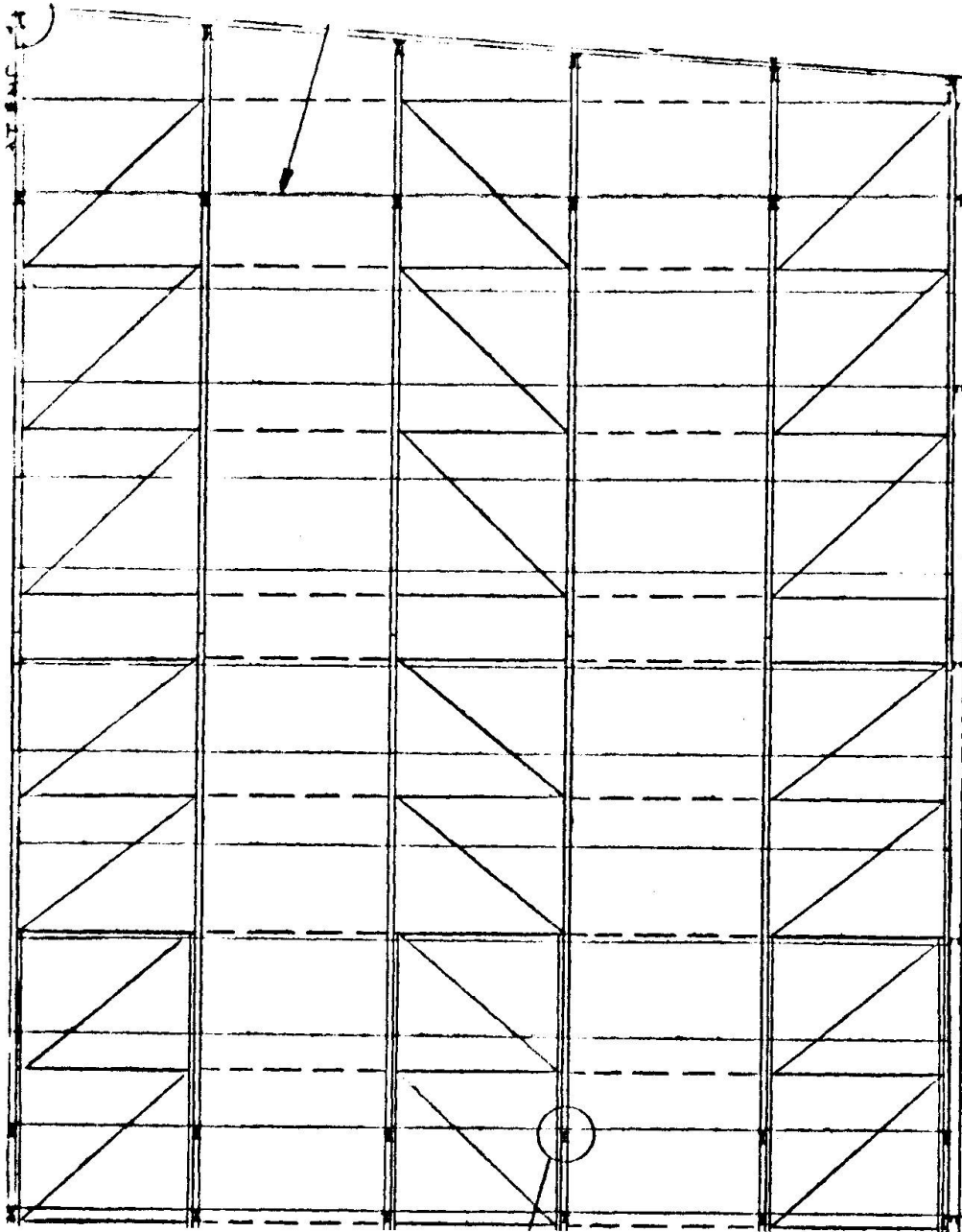

Republic Steel Rack Building Cross Section

4.2 Main Problems: This is a specialized type of building suitable for warehouses and storage purposes. Perhaps the main problem is erection. The foundation must be level and the racks must be erected plumb and on line for the automatic warehousing system to work properly. Accurate shop fabrication of the standard component parts is necessary.

4.3 Future trends: The trend is toward automatic warehousing, computer controlled. This leads to an increase in height of the racks and the buildings. Early buildings were 20 feet high; later buildings have been 40 feet high. Buildings of this type 60 feet high are being considered.

Scaffoldings and Shoring

5.1 State of the Art: The art is at least 70 years old insofar as tubular steel scaffolding is concerned. Several companies in the United States are currently marketing scaffolding and shoring equipment. The product lines are elaborate and include many accessories. Shoring equipment is produced from a larger size diameter tube than the scaffolding equipment; however, it is possible to use scaffolding equipment for shoring, or shoring equipment of scaffolding. The general rule is that scaffolding equipment supports people, while shoring equipment supports forms or material, which becomes part of the building proper. A relatively new development is shoring equipment used as "flying forms" which are fabricated at the first two floors of the building, and then leapfrogged to alternating floors to allow the reuse of the equipment without dismantling between each reuse. The introduction and use of the climbing tower crane from Europe has allowed this innovation in building construction.

5.2 Examples of applications: Patent Scaffolding Company, Long Island City, New York are pioneers in "Flying Shoring". On high-rise structures, it is expensive and wasteful, considering the amount of time, money and manpower required, to erect steel shoring and formwork, only to take it apart and then put it together again for the next floor to be shored. Flying Shoring eliminates this costly operation. Shoring components are set up in sections, complete with lumber form panels, often ahead of time, and swung into position for the initial typical floor area. After the concrete slab is poured and set, a second set of flying shoring sections is positioned on the floor above. For lifting, adjustable extension legs are retracted and each complete section is slid to the edge of the floor. It is then swung out and lifted by tower or climbing crane to the next pour area. Some contractors even prefer to use three floors of shoring for higher jobs.

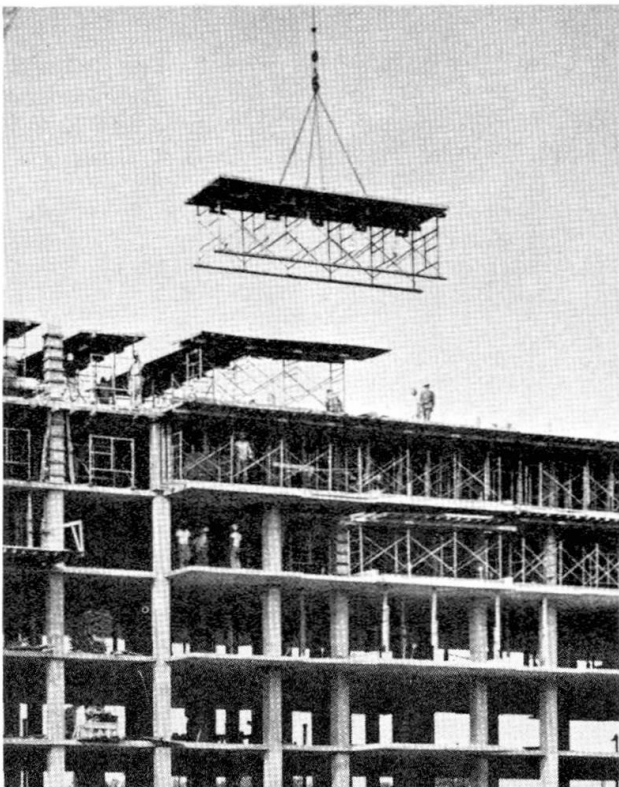

Complete shoring unit is lifted by tower crane to next pour area.

For this 327' tower of the National Shrine of the Immaculate Conception constructed in Washington, D. C. a total of 1750 WACO frames were used.

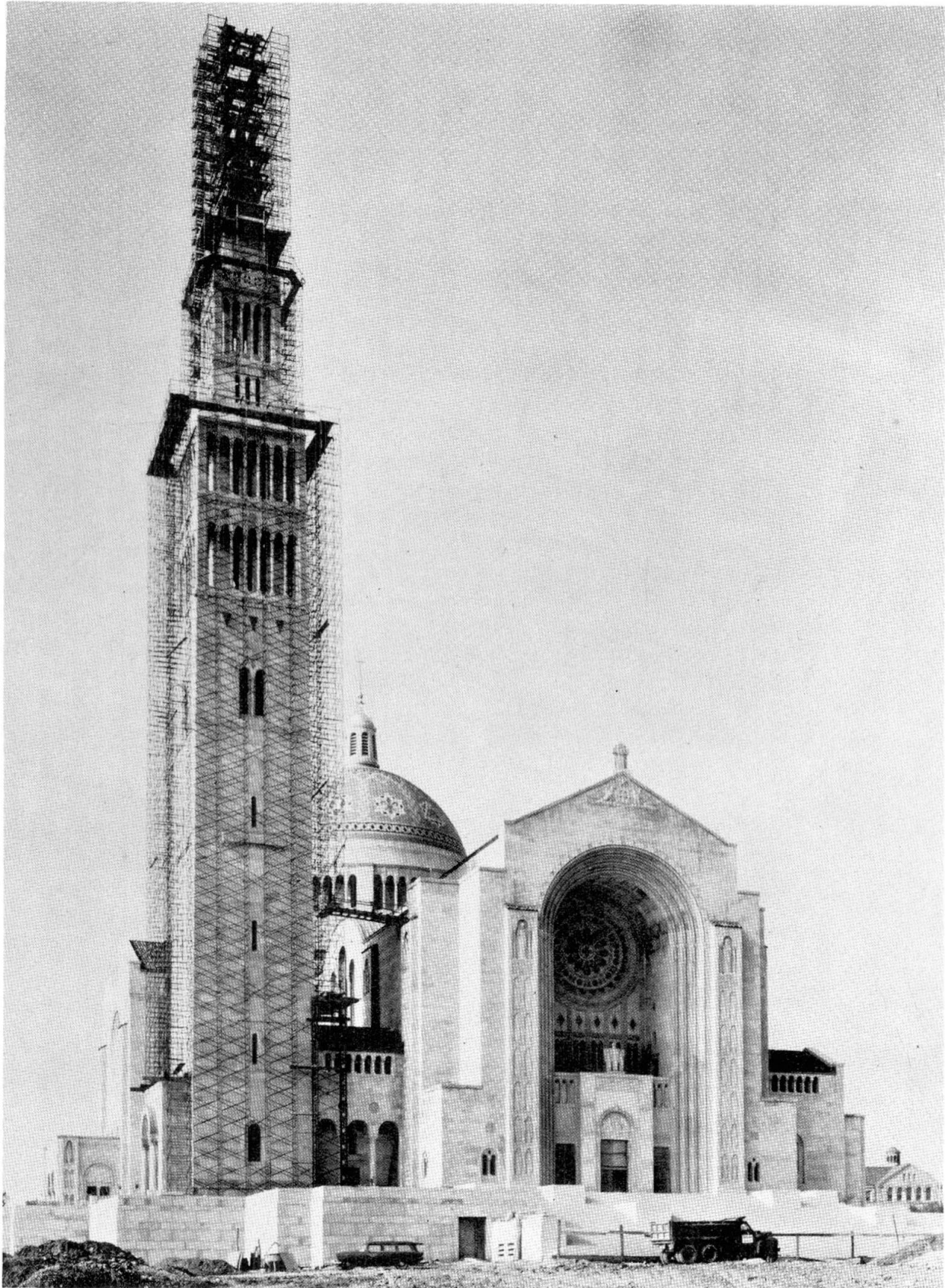

Safeway Steel Products of Milwaukee, Wisconsin produce a SHORE "X" System of shoring adaptable to commercial, industrial and bridge construction. The tower capacity is 44,000 pounds which results normally in fewer towers to be erected and dismantled.

PLAN AND LONGITUDINAL VIEW OF GIRDER BRIDGE
Safeway Steel Products

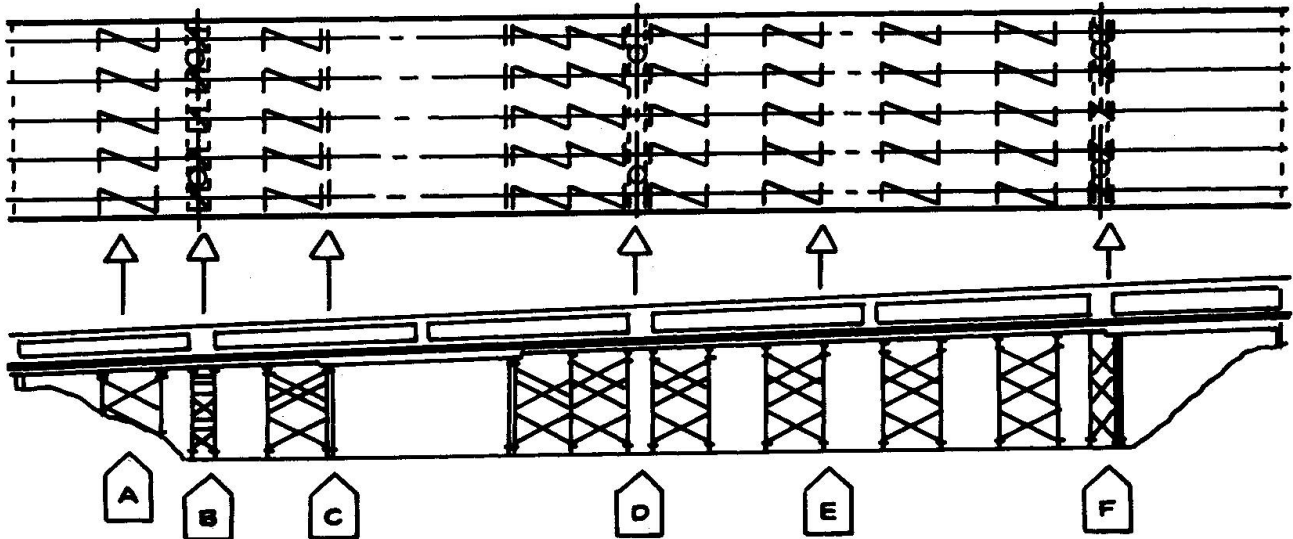

- A. The Extension Frame is inverted and placed in the Base Frame to provide plumb towers on slopes.
- B. Towers placed transversely to the bridge with a continuous cap allows variable spacing of the towers and doubling of stringers where necessary.
- C. Frames are doubled to provide carrying capacity for road opening.
- D. Towers are closely spaced to support extra weight of bent.
- E. Ten foot towers are usually spaced 20 feet on center.
- F. Four foot towers support bent with doubled frames carrying the span over the slope.

5.3 Main Problems: Although the use of scaffolding and shoring by contractors has been a practice for many years the main problem in the industry is improper use of the material. There is a failure on the part of some contractors to observe load capacity requirements, to provide proper base supports, to use the proper grade lumber on top of the shoring. There is a big continuing problem of educating users as to proper and safe procedures.

5.4 Future Trends: Despite the many new construction systems being employed today, the use of steel scaffolding and shoring continues to increase. The present trend is for rental of equipment rather than sale due to economic conditions. Many states are rewriting codes to include steel scaffolding and shoring. There is a slight trend toward larger shoring units with greater load capacity. High strength, 50,000 psi yield steel, is being used generally.

Summary

6.0 This report has illustrated many examples of mass produced steel building components. The business required to design, manufacture and sell mass produced steel building components is big business, conducted mainly by large steel fabricating companies. Computerization of all facets of the business is here and is an essential part of the operation. The industry is dynamic in nature and growing in size. Codes, ordinances, zoning restrictions and union constraints are gradually lessening as designs become more sophisticated and architecturally acceptable. The principal use of steel building components continues to be in industrial and commercial buildings. In conclusion, it can accurately be said that applications of mass produced steel building components are widespread and their use is increasing.

Résumé

Ce rapport présente beaucoup d'exemples d'éléments pour la construction métallique fabriqués en série. Le travail exigé pour la conception, la fabrication et la vente des éléments d'acier préfabriqués en grande série est tel, qu'il doit être fait, le plus souvent, par de grandes entreprises de construction métallique. Le calcul électronique de tous les aspects du problème intervient ici et représente une part essentielle du travail. L'industrie est de nature dynamique et d'importance croissante. Quand les projets deviennent plus étudiés et plus architectoniques, les normes, les ordonnances, les restrictions dues au plans de zones perdent de leur importance. L'utilisation principale des éléments d'acier préfabriqués concerne encore surtout les constructions à caractère industriel ou commercial. On peut affirmer en conclusion que l'application des éléments d'acier préfabriqués en grande série est très large et que leur emploi prend une importance croissante.

Zusammenfassung:

Dieser Bericht hat manche Beispiele von seriengefertigten Bauteilen aus Stahl gezeigt. Entwurf, Herstellung und Verkauf gehört zum grossen

Geschäft und wird hauptsächlich durch grosse Stahlfirmen ausgeführt. Computer gerechte Formulierung aller Probleme ist hier ein wesentlicher Teil der Ausführung. Die Industrie ist ihrer Natur nach dynamisch und wachsend in der Grösse. Normen, Regeln und Zonenplan nehmen entsprechend dem anspruchsvolleren und architektonisch annehmbareren Entwurf ab. Stahl-Bauteile werden am meisten in Industrie- und Geschäfts-Bauten angewendet. Zusammenfassend kann gesagt werden, dass die Anwendung seriengefertigter Stahl-Bauteile weit gestreut ist und deren Verbrauch zunimmt.

Leere Seite
Blank page
Page vide