

**Zeitschrift:** IABSE reports of the working commissions = Rapports des commissions de travail AIPC = IVBH Berichte der Arbeitskommissionen

**Band:** 31 (1978)

**Artikel:** Effective use of structural computer programs

**Autor:** Pfaffinger, D.D.

**DOI:** <https://doi.org/10.5169/seals-24893>

### **Nutzungsbedingungen**

Die ETH-Bibliothek ist die Anbieterin der digitalisierten Zeitschriften. Sie besitzt keine Urheberrechte an den Zeitschriften und ist nicht verantwortlich für deren Inhalte. Die Rechte liegen in der Regel bei den Herausgebern beziehungsweise den externen Rechteinhabern. [Siehe Rechtliche Hinweise.](#)

### **Conditions d'utilisation**

L'ETH Library est le fournisseur des revues numérisées. Elle ne détient aucun droit d'auteur sur les revues et n'est pas responsable de leur contenu. En règle générale, les droits sont détenus par les éditeurs ou les détenteurs de droits externes. [Voir Informations légales.](#)

### **Terms of use**

The ETH Library is the provider of the digitised journals. It does not own any copyrights to the journals and is not responsible for their content. The rights usually lie with the publishers or the external rights holders. [See Legal notice.](#)

**Download PDF:** 02.04.2025

**ETH-Bibliothek Zürich, E-Periodica, <https://www.e-periodica.ch>**

---

IABSE  
AIPC  
IVBH

COLLOQUIUM on:  
"INTERFACE BETWEEN COMPUTING AND DESIGN IN STRUCTURAL ENGINEERING"

August 30, 31 - September 1, 1978 - ISMES - BERGAMO (ITALY)

---

**Effective Use of Structural Computer Programs**  
Utilisation efficace des programmes de structures  
Wirkungsvoller Einsatz baustatischer Computer-Programme

**D.D. PFAFFINGER**

Dr. sc. techn, Senior Consultant  
FIDES Trust Company  
Zürich, Switzerland

**Summary**

The use of structural engineering programs can raise difficulties. Some of the typical problems and their solutions are outlined on an illustrative example. On this basis general aspects of effective use of structural programs are discussed, leading to a list of requirements on the software as well as on the user. In the conclusions some suggestions are made to further improve the effectiveness of use of structural programs in the future.

**Résumé**

L'utilisation de programmes pour le calcul de structures peut conduire à des difficultés. Quelques problèmes typiques ainsi que leur solution sont illustrés par un exemple. On discute sur cette base les aspects généraux de l'utilisation efficace des programmes de structures. Ceci conduit à une série de requêtes concernant autant le logiciel que les utilisateurs. On conclut par quelques suggestions permettant dans le futur d'utiliser les programmes de structures avec encore plus d'efficacité.

**Zusammenfassung**

Der Einsatz baustatischer Computer-Programme kann mit Schwierigkeiten verbunden sein. Anhand eines Beispiels werden einige der typischen Probleme wie auch ihre Lösung aufgezeigt. Vor diesem Hintergrund werden allgemeine Gesichtspunkte des wirkungsvollen Einsatzes solcher Programme erörtert, welche zu einer Reihe von Anforderungen an Programme wie auch Benutzer führen. Die Schlussfolgerungen enthalten einige Vorschläge, um baustatische Programme in der Zukunft noch wirkungsvoller einsetzen zu können.

## 1. INTRODUCTION

Norbert Wiener once estimated that of all problems worked on a computer only 10% were adequately formulated, because in 90% of the cases the solutions had not been conceptually worked out in the mind before coding them for the machine. For structural engineering problems this percentage may not be as pessimistic. The general observation Wiener's, however, remains valid. In structural engineering the solutions of many problems require comprehensive understanding of the problem, knowledge of advanced solution methods and frequently also extensive calculations. Examples for this situation are highly redundant beam structures, plate and shell problems or dynamic analyses. Before the advent of the electronic computer the engineer was hence usually forced to simplify his problem considerably to be able to solve it. The quality of his analysis depended largely on his ability to set up an analysis model which preserved the characteristic properties of the real structure and also to interpret the results obtained from the model with respect to their meaning for the real structure. These tasks had conceptually to be solved by the human brain and not by any calculating device. Today, in spite of the abundance of computer power and the existence of numerous structural engineering programs, this situation basically has not changed.

One frequent cause of problems with electronic calculations stems from this basic misunderstanding: the most comprehensive computer programs and the most powerful machines do not conceptually solve a problem. It is still the engineer who works out the solution conceptually in his mind but uses the computer to do the numerical operations. The engineer's ability to set up the analysis model and to interpret the results is hence still a prerequisite to a meaningful solution as it was before. He may now, however, set up a very complex and comprehensive model and analyse it by means of already coded advanced mathematical procedures without knowing all their details. Other causes of difficulties with computer solutions are: problems in applying the methods of a program properly to the chosen model while observing their limitations and restrictions; bad results due to wrong input data or program errors; time delays due to time consuming input preparation, hardware failures etc.; problems with the evaluation and interpretation of voluminous results.

In order to use the modern computational means effectively, these difficulties have to be reduced. To do so, a number of requirements on modern structural engineering computer programs can be set up ([3], [5], [10], [11], [19], [21]). The user of such programs, on the other hand, has to acquire new skills and attitudes which enable him to use these tools effectively ([6], [12], [13], [16], [17], [20]). While having in mind larger and complex analyses rather than simple routine calculations it is the purpose of this paper, starting with an illustrative example, to investigate these two sets of requirements and to show how to use structural engineering computer programs effectively.

## 2. CASE STUDY

Fig. 1 shows the building site of the new office building of the Bayerische Hypotheken- und Wechsel-Bank in Munich, comprising a conventional office building and a high-rise structure supported by four towers. This latter structure has a total height of 115 m and consists of 33 stories. In Fig. 2 a simplified ground-plan of the arrangement of the floors between the towers is shown. It was planned to transmit all story loads to the towers along one story only by means of a

joint of unreinforced high-strength concrete. Fig. 3 is a section through tower D (Fig. 2) showing the inner core (tower), the outer core (story) and the joint. Circular post-tensioning provided the required compression forces. The extensive numerical analyses posed numerous problems typical for electronic computations. Their solutions hence serve well as an illustration to the subject of this paper.



Fig. 1 View of building site

First linear elastic analyses of the towers under story loads and wind loads had to be performed. One basic modelling problem was the simple representation of the concrete joint. To solve this problem preliminary studies were made comparing an axisymmetric three-dimensional model, a model with excentrically connected membrane elements, a general three-dimensional model and a model with flat shell elements for the joint (programs ANSYS, NASTRAN, ROST, [2], [7], [8], [9], [18]). Evaluation of the results (Fig. 4) showed that the joint could well be represented by the simple membrane model.

For one of the towers it was decided to perform a limit load analysis. This created serious methodical and modelling problems because none of the available non-linear programs possessed all of the required facilities. A solution was obtained by deciding on an approximate solution based on the lower bound

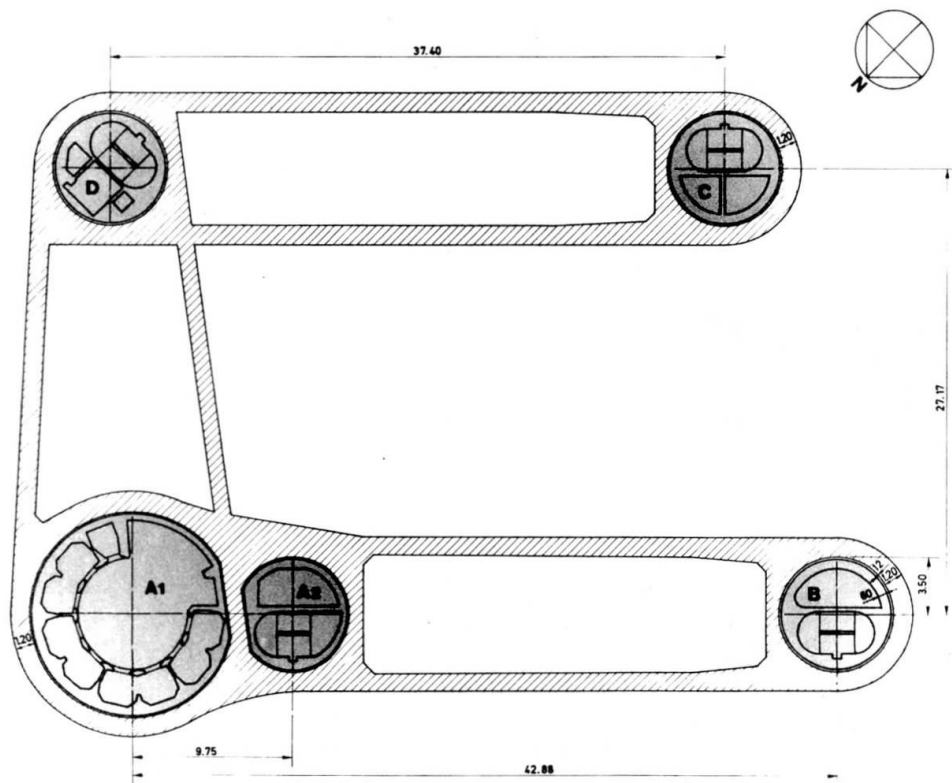

Fig. 2 Simplified ground-plan of structure

theorem of limit analysis and using an elastic anisotropic membrane material model ([1], [14], [15]). Extensive preliminary numerical tests were performed to define the material constants of the limit load model and to verify the solution algorithm.

A number of familiar problems arose for the different analyses, which were performed with MSC/NASTRAN. The problem of checking the input data could be solved by using mesh generators and plotting (Fig. 5) as well as by printing specific tables and matrices. The voluminous numerical results were represented graphically as for instance in Fig. 6. Numerous hand calculations and checks were done to verify the results. A specific problem arose for parts of the structure which were modelled by three-dimensional elements. The interpretation of the calculated stress field with respect to the dimensioning could not be solved satisfactorily. This problem stems from the lack of an adequate dimensioning theory for three-dimensional reinforced concrete structures.

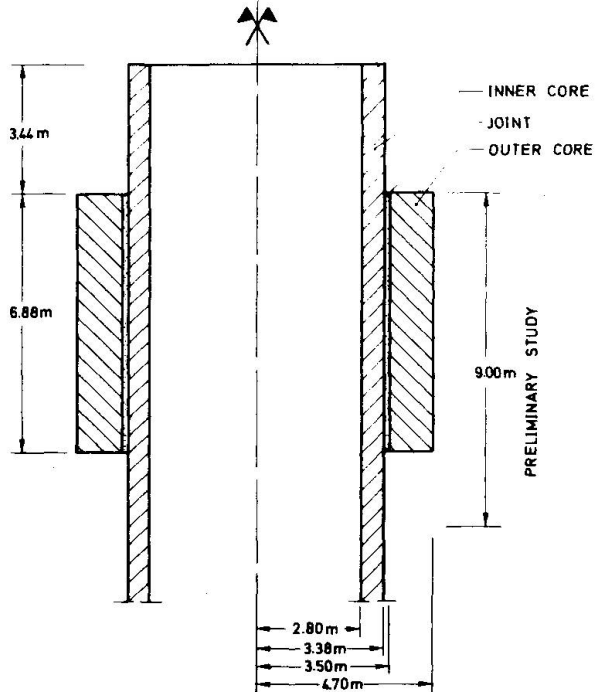

Fig. 3 Cross-section of tower D

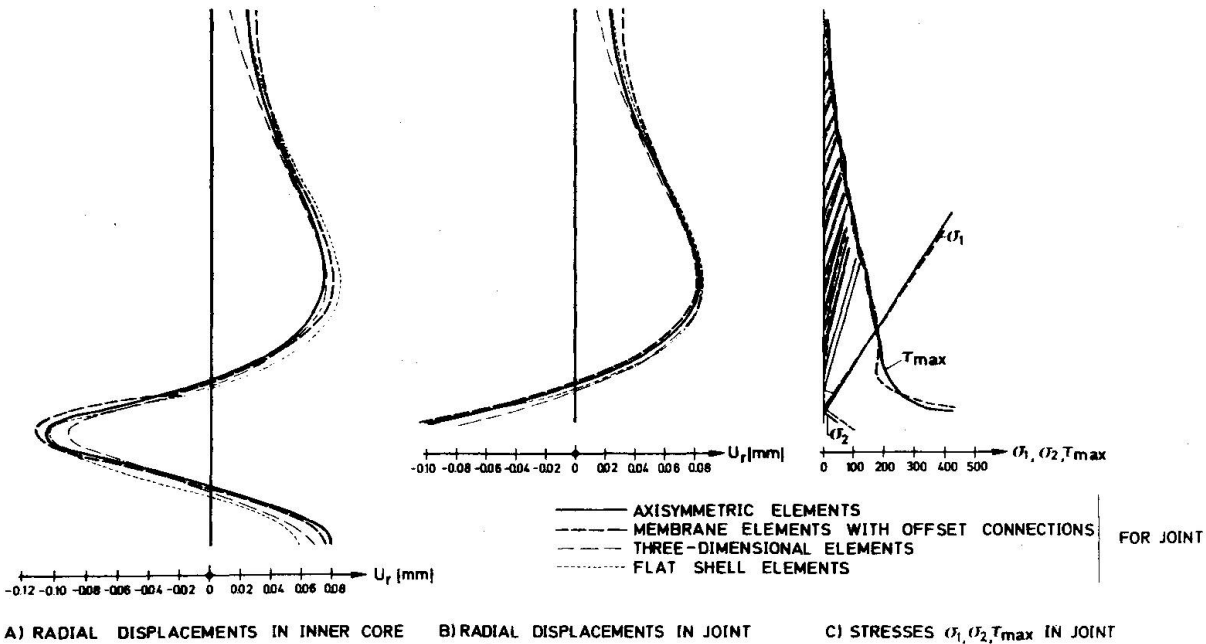
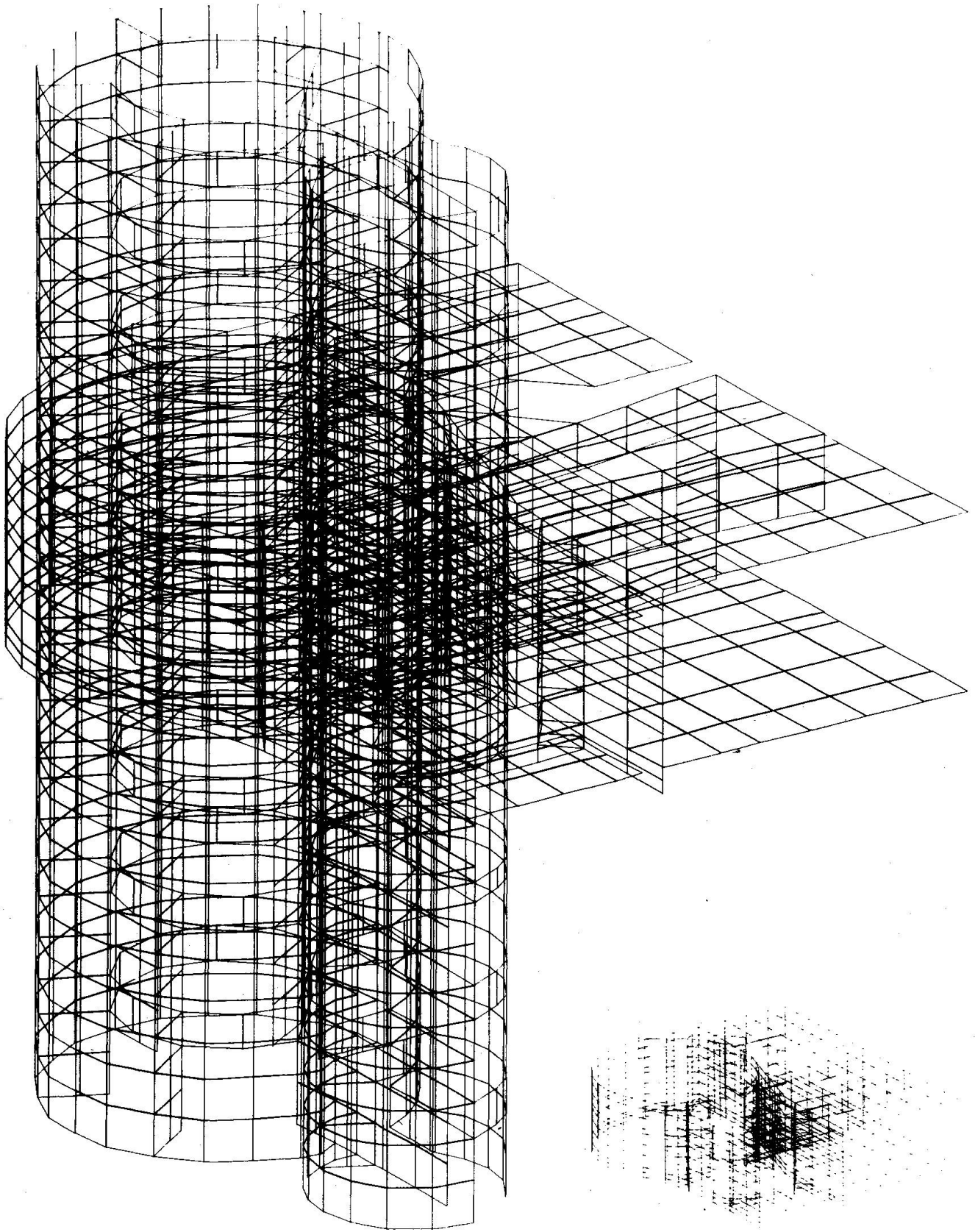

Fig. 4 Results for different models for the joint under axisymmetric loading

The performed analyses showed that the structure and especially the joint were statically sound under the service loads as well as under limit load conditions. In spite of this fact and due to other reasons it was decided, however, to use reinforced concrete also for the joint.



Full mesh

Detail

Fig. 5 Mesh of towers A1 and A2



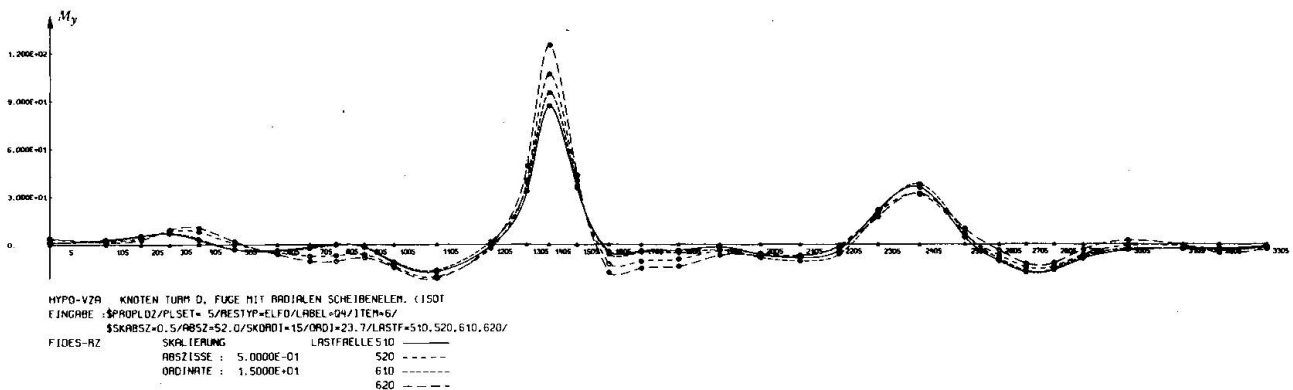

Fig. 6 Plot of bending moments  $M_y$  along vertical section of tower

### 3. REQUIREMENTS ON STRUCTURAL ENGINEERING PROGRAMS

The above case study illustrated the fact that many computer solutions are by no means off-the-shelf solutions and usually require consideration of several aspects of the problem. Fig. 7 shows the different phases of a typical structural analysis and their interaction. The most demanding phases are the setting up of the conceptual analysis model and the interpretation of the results. In the first one, the solution concept is worked out (statement of the problem, simplifications, required algorithms etc.) while considering all additional conditions such as available programs, available computer capacity, required accuracy, time frame and budget. From the interpretation of the results consequences for the real structure as well as for all phases of the solution are derived. The phase of preparing the numerical model is in close interaction with the conceptual model. Solving the problem for the numerical model and displaying the results allows the derivation of conclusions. Structural engineering computer programs can provide the means for the user, to accomplish the tasks of some of these phases very effectively. In the following hence the most important requirements on structural programs to permit effective use are discussed.

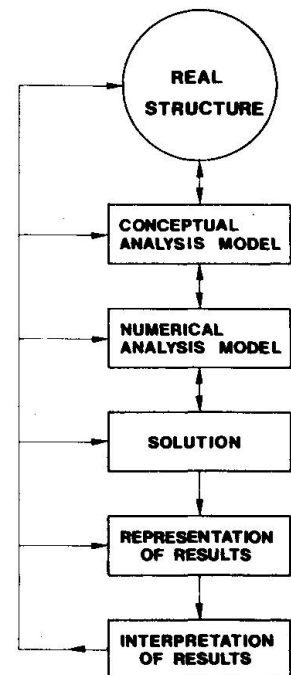

Fig. 7 Phases of solution

#### 3.1 Easy data preparation and verification

This requirement concerns the phase of setting up the numerical model. It means, that a program should offer data generators, extensive facilities for graphical displays and print options for important lists such as for instance element connection tables in finite element analyses. The program also has to perform comprehensive formal tests on the input data and has to furnish meaningful error messages. Due to the importance of easy preparation of the numerical data several preprocessor systems exclusively for this task for finite element models are under development or are already available. These systems allow the definition of the model in a unified input language or by means of interactive graphics,

they perform extensive checks and produce the formatted input cards for several FE-programs at the user's option.

### 3.2 Efficient and verified numerical procedures

The fast development of the computing facilities has led to very active development of new numerical methods. Big progress with respect to efficiency and reliability has been made over the past years in such fundamental tasks as decomposition, forward-backward substitution, eigenvalue extraction or integration of the coupled equations of motion. It is a requirement that a modern structural engineering program should have incorporated advanced numerical techniques. The numerical procedures have to be tested and verified. In the case of finite element programs new elements have to pass a series of tests before they are made available to the user. The requirement of verified procedures also means, that the program can print out fundamental characteristic magnitudes for the procedure such as residual forces, number of negative terms on the diagonal of the triangular factor, error bounds for eigenvalues and so on.

### 3.3 Generation and representation of results

It is essential, that a program can produce all the results necessary for the interpretation phase. Depending on the problem this can mean displacements, velocities, accelerations, reactions, forces and stresses, strains, strain energies, corner forces etc. It is also a basic requirement that the usually voluminous results of a structural engineering program can be displayed in a condensed way. Here the graphical means play an important role. It is also required, that results can be demanded in a selective way and that by means of a cheap restart more results can be obtained. There is a trend to separate the task of representing the results from the main program by means of postprocessors.

### 3.4 Intermediate results and user interaction

For programs for more advanced applications, such as nonlinear applications or dynamics, it is required that intermediate results can be produced at the user's option. The user has to be in the position to print intermediate matrices such as stiffness or damping matrices and also intermediate results as for instance after every load step in nonlinear analyses. These intermediate results can be essential also during the phase of finding the conceptual model if computer runs are made to verify the assumptions. User interaction is usually required to an increasing degree in large and/or complex problems. This includes capabilities of the program to restart after a machine failure by using saved intermediate results and also to restart for more load cases, eigenvalues, load or time steps.

### 3.5 Documentation

A basic requirement for all computer programs is thorough documentation. Here first of all the user's documentation has to comprise all information necessary to use the program. The limits of applicability have to be clearly stated. For programs for advanced applications also documentation of the methods and mathematical procedures, their applicability, their implementation and verification is required. It also means documentation of a collection of examples.



3.6 Maintenance, development, support

Computer programs have to be maintained. Error corrections have to be made and improvements have to be incorporated. Programs should be kept up to date with new technologies and new mathematical procedures. One final but basic requirement is the support of a program and its users. This means especially professional support of the user to apply the capabilities of the program adequately and assistance in the case of difficulties. This support can be provided by the developer or by specially trained professional people. For large structural engineering programs with a wide range of capabilities the quality of the support can become the decisive factor for effective or ineffective use.

4. REQUIREMENTS ON THE USER

Many technological achievements like the car or the telephone are used to-day without understanding the details of their functioning. It is the user, however, who bears the final responsibility of using these means adequately. To do so, certain new skills are required. In a comparable sense this situation exists also for usage of computer programs. In Fig. 8 the degree of automation for the different phases of a typical computer solution of a structural problem is qualitatively sketched. It is seen that the phases of setting up the conceptual model and of interpreting the results can very little be automated and are thus left to the user. Here as well as in the other phases only a knowledgeable user can master his tasks effectively. In the following hence the most important skills and requirements on a user of structural programs are discussed.

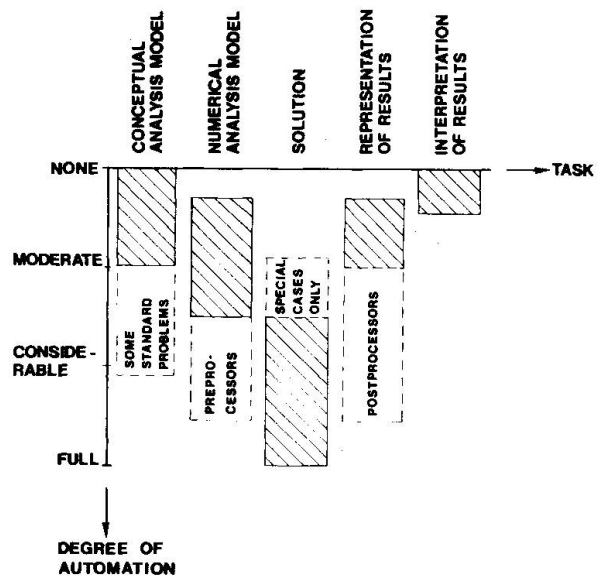

Fig. 8 Degree of automation

4.1 Understanding of the problem

In order to set up the conceptual model and to interpret the results effectively, the user has to understand his problem from an engineering point of view. He has to comprehend the basic behavior of the structure and the type of analysis that is required. The understanding of his problem enables the user to find the appropriate model, to perform plausibility checks and to distinguish unexpected results from erroneous results. This engineering insight into a problem can be gained by experience, by successive studies of the problem with increasing complexity and to a certain extent by formal training.

4.2 Understanding of the solution methods

It is seen from Fig. 8, that the solution for the numerical model is usually

highly automated. In spite of this, all solution algorithms have peculiarities and limitations which have to be known to the user in order to use them effectively. It is thus required that the user has a working knowledge of these methods from the applications point of view. This means understanding of the basic assumptions, properties and limitations of the methods. As many engineering problems lead to the same mathematical expressions the knowledge of their numerical solution methods also sometimes allows the solution of problems by analogy.

#### 4.3 Knowledge of the computational facilities

Before setting up a major analysis model the user is required to check on the computational facilities. The availability and capacity of the hardware has to be investigated. The available programs for the calculations in mind have to be evaluated and a selection has to be made. The different restrictions from hardware, software, budget, time frame etc. have to be considered at the very beginning of a major analysis and the solution concept has to be defined accordingly. Here close cooperation with specialists in different fields may be required.

#### 4.4 Critical attitude

The engineer, who is finally responsible for the calculations, is required to be critical towards the calculated results. He has to check the adequacy of the assumptions for the model, the solution path and the results. Only verified results can be used as a basis for decisions.

### 5. CONCLUSIONS

The highly competitive market of structural engineering computer programs has led to substantial improvements in the reliability, capabilities and easiness of use of such programs. Yet there still remains much to be done. It is proposed, that the evaluation and the quality control of programs is done to a still greater extent by the engineering community. This could be done by the professional societies which then would also organize the exchange of such information. It is also proposed that high emphasis is put on the development of general purpose data preparation and result evaluation programs. Here the capabilities of mini-computers for interactive work might prove to be of great value.

Many difficulties with electronic computations stem from the inadequate preparation of the user to his tasks. Here much remains to be done concerning the training of the engineers. More emphasis should be given to courses which develop the basic understanding of structural behaviour and also to courses on the principles of modern numerical methods. In spite of all sophistication in computers and programs it is and will still be the human mind which conceptually has to solve the problems before going on a computer. The critical and knowledgeable engineer, however, will be able to use these modern computational means to set up analysis models closer and closer to reality which will also permit him to solve his main task - to design structures - more effectively.

#### Acknowledgements

Most of the numerical analysis cited here was done by FIDES Rechenzentrum GmbH,

München under a contract with Dyckerhoff + Widmann AG and Held + Franke AG, both Munich, with the author as consultant for the electronic computations. The kind permission of Dyckerhoff + Widmann AG, and Held + Franke AG to cite this project and to show some results of the analysis is gratefully acknowledged.

### References

1. Argyris, J.H., Faust, G., Willam, K.J., Limit Load Analysis of Thick-Walled Concrete Structures - a Finite Element Approach to Fracture. Computer Methods in Applied Mechanics and Engineering, 8. 1976.
2. De Salvo, G., Swanson, J., ANSYS Engineering Analysis System User's Manual. Swanson Analysis Systems, Inc., Elizabeth, PA. 1975.
3. Fenves, S.J., Methods Appropriate to an Engineering Software Center. ASCE Annual National and Environmental Engineering Meeting, New York. 1973.
4. Fredriksson, B., Mackerle, J., Structural Mechanics Finite Element Computer Programs, Parts I and II. Linköping Institute of Technology, Dep. of Mechanical Engineering. 1975.
5. Gallagher, R.H., Trends and Directions in the Applications of Numerical Analysis. Numerical and Computer Methods in Structural Mechanics. Fenves, S., Perrone, N., Robinson, A., Schnobrich, W., Editors. Academic Press, New York and London. 1973.
6. Huré, D., Morysse, M., Comparative Methods for Analysis of Piping Systems Subjected to Seismic Motion. Nuclear Engineering and Design, 38. 1976.
7. Kohnke, P., ANSYS Engineering Analysis System Theoretical Manual. Swanson Analysis, Inc., Elizabeth PA. 1977.
8. MacNeal, R.H., Editor, The NASTRAN Theoretical Manual. NASA SP-221 (01). 1972.
9. McCormick, C.W., Editor, The MSC/NASTRAN User's Manual. The MacNeal-Schwendler Corp., Los Angeles. 1977.
10. Medearis, K., An Investigation of the Feasibility of Establishing a National Civil Engineering Software Center. ASCE, New York. 1973.
11. Pauli, K., Programmwünsche-Weisse Flecken, Hefte 1,2,3. Hauptverband der Deutschen Bauindustrie, Wiesbaden. 1975.
12. Pfaffinger D., Computer-Graphik als Hilfsmittel des Bauingenieurs. Schweizerische Bauzeitung, 92. Jahrgang, 3. 1974.
13. Pfaffinger D., Comparative Seismic Analysis. Proc. 3rd NASTRAN European User's Conference, Munich. 1976.
14. Pfaffinger D., Thielen G., Limit Load Analysis of a Concrete Structure. Proc. 5th NASTRAN European User's Conference, Munich. 1978.

15. Phillips, D., Zienkiewicz, O., Finite Element Non-Linear Analysis of Concrete Structures. Proc. Instn. Civ. Engineers, Part 2, Vol. 61. 1976.
16. Polónyi, S., Reyer, E., Zuverlässigkeitsbetrachtungen und Kontrollmöglichkeiten (Prüfung) zu praktischen Berechnungen mit der Finiten-Element-Methode. Die Bautechnik, 11. 1975.
17. Robinson, J., A Single Element Test. Computer Methods in Applied Mechanics and Engineering, 7. 1976.
18. ROST-Handbuch. FIDES Rechenzentrum, Publ.-Nr. 30, Zürich. 1970.
19. Stillman, R.B., Trends in Computer Software. Structural Mechanics Computer Programs, Pilkey, W., Saczalski, K., Schaeffer, H., Editors. University Press of Virginia, Charlottesville. 1974.
20. Svalbonas, V., Transient Dynamic and Inelastic Analysis of Shells of Revolution - a Survey of Programs. Nuclear Engineering and Design, 37. 1976.
21. The State-of-the-Art of Computer Graphics. Applications in Structural Engineering. Report of the Task Committee on Computer Graphics of the Committee on Electronic Computation, ASCE Structural Division. ASCE National Structural Engineering Meeting. 1973.

Leere Seite  
Blank page  
Page vide