

**Zeitschrift:** IABSE reports of the working commissions = Rapports des commissions de travail AIPC = IVBH Berichte der Arbeitskommissionen

**Band:** 34 (1981)

**Artikel:** Stress analysis of structural members taking complex materials behaviour into consideration

**Autor:** Roelfstra, P.E. / Wittmann, F.H.

**DOI:** <https://doi.org/10.5169/seals-26887>

### **Nutzungsbedingungen**

Die ETH-Bibliothek ist die Anbieterin der digitalisierten Zeitschriften. Sie besitzt keine Urheberrechte an den Zeitschriften und ist nicht verantwortlich für deren Inhalte. Die Rechte liegen in der Regel bei den Herausgebern beziehungsweise den externen Rechteinhabern. [Siehe Rechtliche Hinweise.](#)

### **Conditions d'utilisation**

L'ETH Library est le fournisseur des revues numérisées. Elle ne détient aucun droit d'auteur sur les revues et n'est pas responsable de leur contenu. En règle générale, les droits sont détenus par les éditeurs ou les détenteurs de droits externes. [Voir Informations légales.](#)

### **Terms of use**

The ETH Library is the provider of the digitised journals. It does not own any copyrights to the journals and is not responsible for their content. The rights usually lie with the publishers or the external rights holders. [See Legal notice.](#)

**Download PDF:** 30.03.2025

**ETH-Bibliothek Zürich, E-Periodica, <https://www.e-periodica.ch>**

## **Stress Analysis of Structural Members Taking Complex Materials Behaviour into Consideration**

Analyse des contraintes d'éléments structurels en tenant compte du comportement complexe des matériaux

Spannungsanalyse von Bauteilen unter Berücksichtigung des komplexen Materialverhaltens

**P.E. ROELFSTRA**

Research engineer

Laboratory for Building Materials, Swiss Federal Institute of Technology,  
Lausanne, Switzerland

**F.H. WITTMANN**

Prof. Dr.

### **SUMMARY**

In structural analysis it is essential to introduce realistic materials laws. In this contribution creep and shrinkage of concrete are calculated on the basis of a rather general materials model. In addition heat and moisture diffusion are taken into consideration. Concrete need not be considered as a homogeneous material. The actual heterogeneous macrostructure can be simulated. The materials laws derived in this report are used to analyse a conventional cross-section of a prestressed concrete bridge.

### **RÉSUMÉ**

Dans l'analyse des structures, il est essentiel d'introduire des lois réalistes pour décrire le comportement des matériaux. Dans cette contribution, le retrait et le fluage du béton sont calculés sur la base d'une modélisation assez générale des matériaux. De plus, la diffusion de chaleur et d'humidité est également prise en considération. Le béton ne peut pas être considéré comme un matériau homogène. La macrostructure hétérogène est simulée sur ordinateur. On utilise les lois obtenues pour analyser la section transversale conventionnelle d'un pont en béton précontraint.

### **ZUSAMMENFASSUNG**

Bei der Berechnung von Betonkonstruktionen ist es besonders wichtig realitätsnahe Materialgesetze zu verwenden. In diesem Beitrag werden Kriechen und Schwinden auf der Basis eines allgemeinen Gefügemodells formuliert. Zusätzlich werden Wärme- und Feuchtigkeitsdiffusion berücksichtigt. Beton muss nicht notwendigerweise als ein homogenes Material betrachtet werden; das heterogene Gefüge kann vielmehr im Grossrechner generiert werden. Die hier abgeleiteten Materialgesetze werden beispielhaft zur Berechnung eines Querschnittes einer üblichen vorgespannten Betonbrücke verwendet.



## 1. INTRODUCTION

Recently in many countries serious defects have been observed on prestressed and normally reinforced bridges. These difficulties can be traced back to a number of reasons such as aggressive climatic conditions caused by a dense industrialisation and corrosion problems caused by the application of de-icing salts. There remains, however, another purely mechanical reason. By this we mean the use of non-appropriate or over-simplified materials laws in structural analysis and partly also the sheer lack of knowledge on materials properties.

This obvious deficiency is contrasted by sophisticated modern computer facilities. In a number of reports the potential of computerized structural analysis has been demonstrated in a convincing way (see f.e. /1,2/). Until now the application of these elegant methods is, however, seriously limited because there exists no comparable advanced approach on the materials science side.

The essential aim of this report is to help to fill this gap. Therefore we tried to simulate materials behaviour under varying conditions on the basis of the physical and chemical processes involved /3,4/. It is shown how these model laws can be introduced in structural analysis. As an example we choose arbitrarily a conventional cross section of a prestressed concrete bridge. Our approach is outlined in particular by means of the analysis of one characteristic corner of the structure.

This contribution clearly points out the urgent need for a close link between materials science and structural engineering. The common effort of these two different disciplines is nowadays often called concrete mechanics.

## 2. SIMULATION OF TIME-DEPENDENT DEFORMATION

### 2.1 Model for Creep and Shrinkage

In recent years much progress has been made in materials science in describing the time-dependent behaviour of hardened cement paste with models based on real mechanisms. One of these models by which good results have been obtained is the Munich-model /5/. By means of this model it is possible to describe the main influence on time-dependent deformation of hardened cement paste such as temperature and humidity.

This model describes quantitatively the unrestrained shrinkage. The unrestrained shrinkage or unrestrained swelling is the immediate hygral relative volume change of an infinite small volume element of hardened cement paste if the water content is changed. Klug /6/ and Feldman /7/ have determined experimentally the relationship between unrestrained shrinkage and the relative humidity. It turned out that unrestrained shrinkage  $\epsilon_U$  can be described satisfactorily as function of relative humidity  $H$  by a linear relationship if the extreme regions are excluded :

$$\epsilon_U = aH + b \quad (1)$$

It is important to notice that unrestrained shrinkage is not time-dependent.

In the Munich-model creep is described as a rate process. The rate theory provides a solid theoretical basis for a rather general approach to study creep processes of materials.

The rate of creep of loaded hardened cement paste is then given by the following equation :

$$\frac{\partial \epsilon}{\partial t} = C e^{-\frac{Q}{RT}} \sinh \frac{V}{RT} \sigma \quad (2)$$

In this equation the symbols have the following meaning :

- Q = activation energie;
- V = activation volume;
- R = gas constant;
- T = temperature;
- $\sigma$  = stress;
- C = a quantity proportional to the density of creepcenters in a unit volume.

Q and V do not depend on the duration of the applied stress. The time-dependence of the rate of creep is given by quantity C. For constant stress, humidity and temperature the change of C as function of time can be written as :

$$C = C_1 t^{-m} \quad (3)$$

This assumption leads to the well known creep formulae :

$$\epsilon = at^n \sinh b\sigma \quad (4)$$

$C_1$  is dependent on the type of concrete and the age of loading. A reasonable assumption leads to the well-known double power law.

## 2.2. Diffusion Processes

### 2.2.1. Moisture movement

Pihlajavaara /8/ and Bazant /9/ showed that the diffusion equation for drying of hardened cement paste can be written as :

$$\dot{H} - \text{div} (D_H \text{ grad } H) = 0 \quad (5)$$

In this equation the symbols have the following meaning :

- H = pore humidity;
- $D_H$  = hygral diffusion coefficient.

$D_H$  depends on the pore humidity H because the pore system and the transport mechanisms change when drying proceeds. The drying process is thus nonlinear. So far very little is known on the exact relationship between  $D_H$  and H. The calculations described in this report are carried out by assuming a dependence of  $D_H$  as indicated by Bazant /9/.

### 2.2.2 Heat of hydration

The general equation governing the temperature distribution in a real solid can be written as :

$$\alpha_p \dot{\theta} - \text{div} (K \text{ grad } \theta) - \dot{S} = 0 \quad (6)$$



$\alpha$  = specific heat  
 $\rho$  = density  
 $K$  = conductivity  
 $\theta$  = temperature C  
 $\dot{S}$  = rate of liberation of heat of hydration

This problem can be solved numerically if the boundary conditions are given and all the materials parameters are known.

In the formulae (1) to (6) the coefficients are materials parameters and thus depend on water/cement-ratio, degree of hydration and type of cement apart from other influences. Some of these parameters are not known well enough. There is an urgent need for further experimental work.

### 2.3 Influence of Heterogeneous Structure of Concrete

So far we have considered concrete to be a homogeneous material. In order to be able to study the influence of parameters such as grain size and grain geometry or cement content it is necessary to take the real macrostructure of concrete into consideration. This can be done by generating random structures in a computer. In Figure 1 two runs of the structure generation program are shown as a typical example.

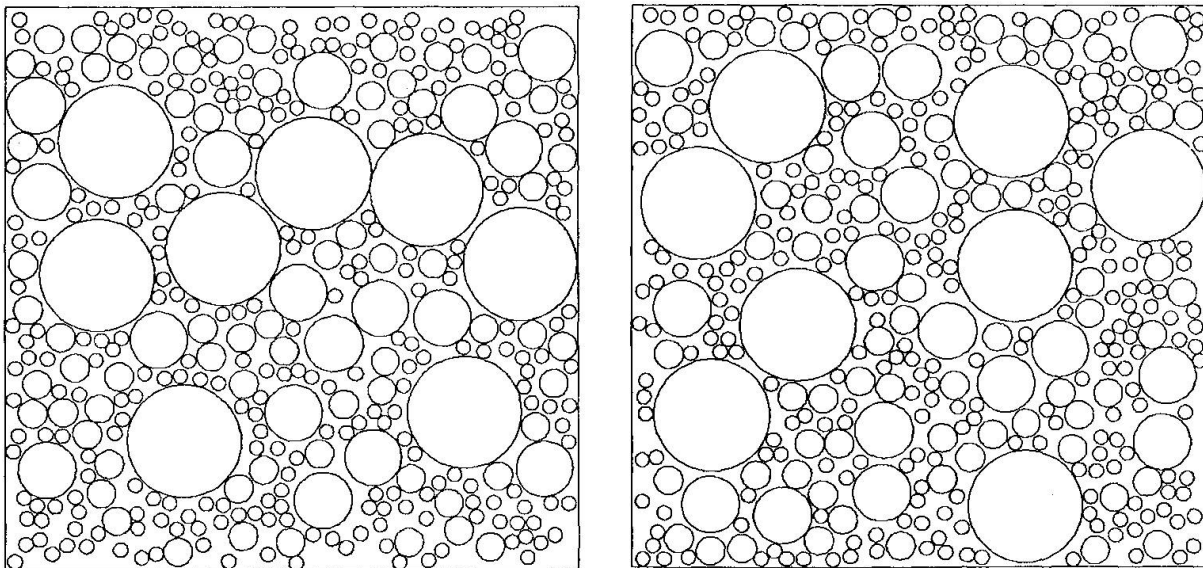

Figure 1 : Two computer generated random structures of concrete.

In this example all aggregates are chosen to be circular. This is, however, not a necessary condition and arbitrary geometries can be generated as well. Any granulometry and arbitrary shape factors can be simulated.

Once the diffusion coefficient of the mortar is known, the behaviour of the composite material can be predicted. The method of finite element analysis has proved to be successful in this connection.

### 3. ANALYSIS OF REAL STRUCTURES BY APPLYING BASIC MATERIALS LAWS

The materials laws as described in section 2 will now be used to analyse a real

structure. As an example a bridge has been chosen. Figure 2 shows a side-view and two cross-sections of a serial lanced prestressed concrete bridge.

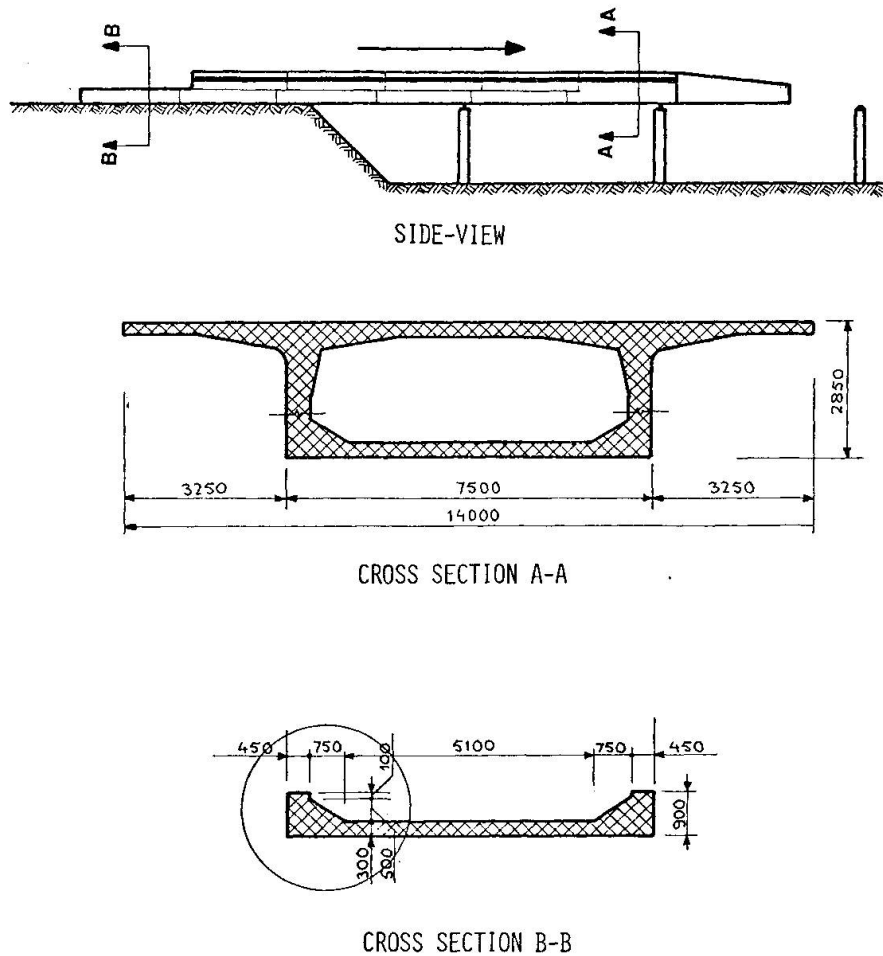

**Figure 2 :** Side view and cross sections of a typical serial lanced prestressed concrete bridge.

The floor and the two corners of the box-girder (cross-section B-B) are usually concreted one week before the upper-section is concreted. First of the temperature distribution in cross-section B-B due to heat of hydration is calculated. The assumption has been made that the flow of heat is two-dimensional in this cross-section. It is also assumed that the flow of heat through surfaces with shuttering is 5 times smaller than through boundaries without shuttering. The temperature of the fresh concrete was supposed to be 18 C.

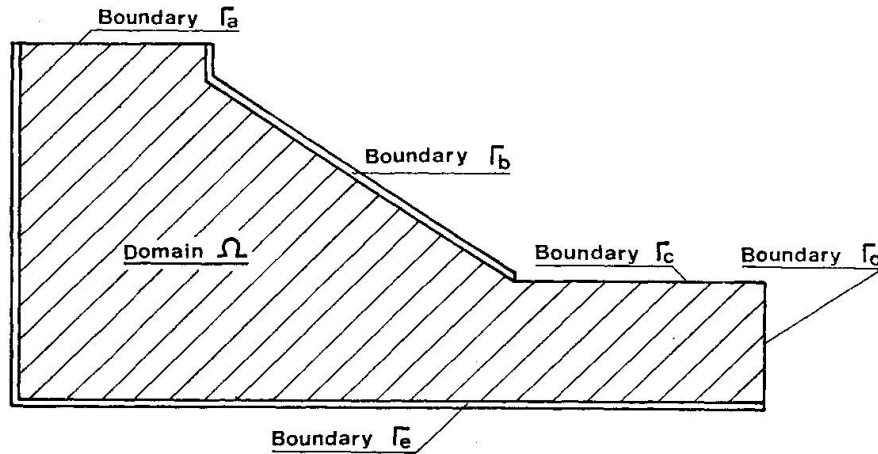

Differential Equation in Domain  $\Omega$  :

$$\alpha \rho \dot{\Theta} - \text{div}(K \text{grad} \Theta) - \dot{S} = 0$$

$$\alpha = \text{specific heat} \quad 800 \quad \frac{\text{J}}{\text{kg} \text{ } ^\circ\text{C}}$$

$$\rho = \text{density} \quad 2500 \quad \frac{\text{kg}}{\text{m}^3}$$

$$K = \text{conductivity} \quad 8000 \quad \frac{\text{J}}{\text{m} \text{ } ^\circ\text{C} \text{ h}}$$

$\Theta = \text{temperature } ^\circ\text{C}$

$\dot{S} = \text{rate of liberation of heat of hydration} =$

$$162000 \times 2^{0.1(\Theta(t)-20)} e^{-0.009 \int_0^t 2^{0.1(\Theta(\tau)-20)} d\tau} \quad \frac{\text{J}}{\text{m}^3 \text{ h}}$$

Boundary Conditions : on  $\Gamma_a$  and  $\Gamma_c$  :

$$q_n = 1000000 (\Theta - 20) \quad \frac{\text{J}}{\text{m}^2 \text{ h}}$$

$$\text{on } \Gamma_b : \quad q_n = 200000 (\Theta - 20) \quad \frac{\text{J}}{\text{m}^2 \text{ h}}$$

$$\text{on } \Gamma_e : \quad q_n = 200000 (\Theta - 15) \quad \frac{\text{J}}{\text{m}^2 \text{ h}}$$

$$\text{on } \Gamma_d : \quad q_n = 0 \quad \frac{\text{J}}{\text{m}^2 \text{ h}}$$

Initial Condition :  $\Theta(x, y, 0) = 18 \text{ } ^\circ\text{C}$

**Figure 3** : Differential equation, boundary, and initial conditions for temperature development.

In figure 3 the mathematical "translation" of this problem is indicated.

Figure 4 shows how domain  $\Omega$  is subdivided into smaller domains, representing the finite elements.

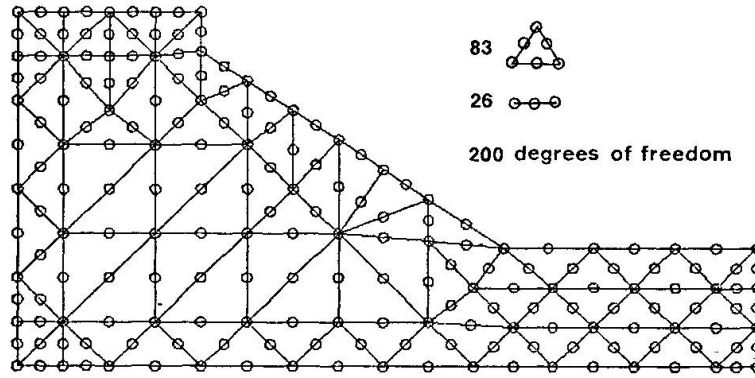

Figure 4 : Finite element idealization.

For the analysis 83 triangle elements with 6 nodes and 26 membrane elements with 3 nodes have been used. In Figure 5 the calculated temperature distribution at 3 different times after concreting are drawn by means of isotherms.

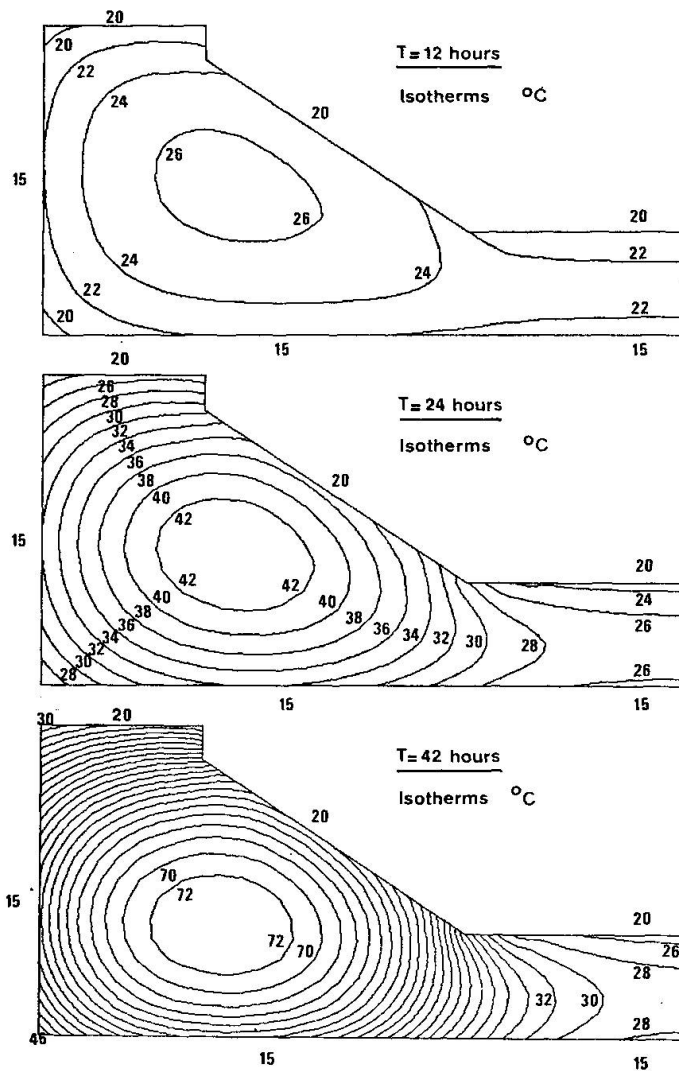

Figure 5 : The calculated temperature distributions at three different times of hydration.





42 hours after concreting the temperature in the core of the corner is about 72 C and the temperature gradients in the directions of the boundaries have reached their maximum. In this situation concrete has become rigid and when the temperature goes down again due to diffusion and the gradients have disappeared this will result in initial stresses which can introduce cracking and which influence total deformation.

Next the drying process of this cross section is simulated. The same finite element idealization has been used. The relative humidity inside the box-girder and of the surrounding air are supposed to be 80 and 70 % respectively. In figure 6 the applied differential equation, the boundary, and the initial conditions are indicated.

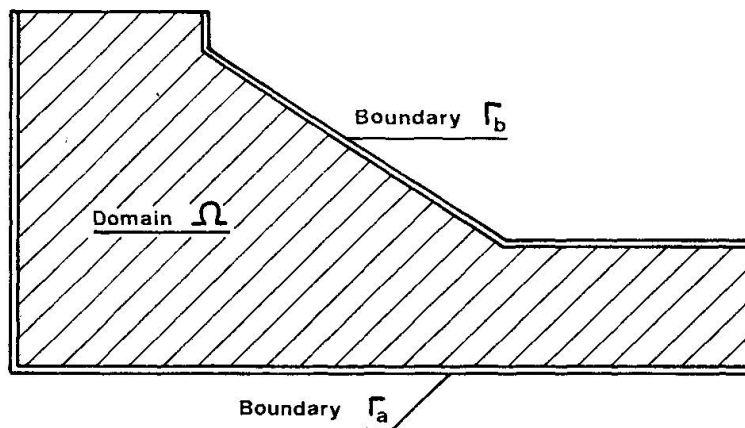

Differential Equation in Domain  $\Omega$  :

$$\dot{H} - \text{div}(D_h \text{grad} H) = 0$$

With :

$$D_h = 2 \left[ 0.05 + \frac{0.95}{1 + \left( \frac{100 - H}{25} \right)^4} \right] \frac{\text{mm}^2}{h}$$

On boundary  $\Gamma_a$  :

$$q_n = 10(H - 70) \frac{\text{mm}}{h}$$

On boundary  $\Gamma_b$  :

$$q_n = 10(H - 80) \frac{\text{mm}}{h}$$

Initial Condition :

$$H(x, y, 0) = 100 \quad \text{in domain } \Omega$$

Figure 6 : Differential equation, boundary and initial conditions for drying.

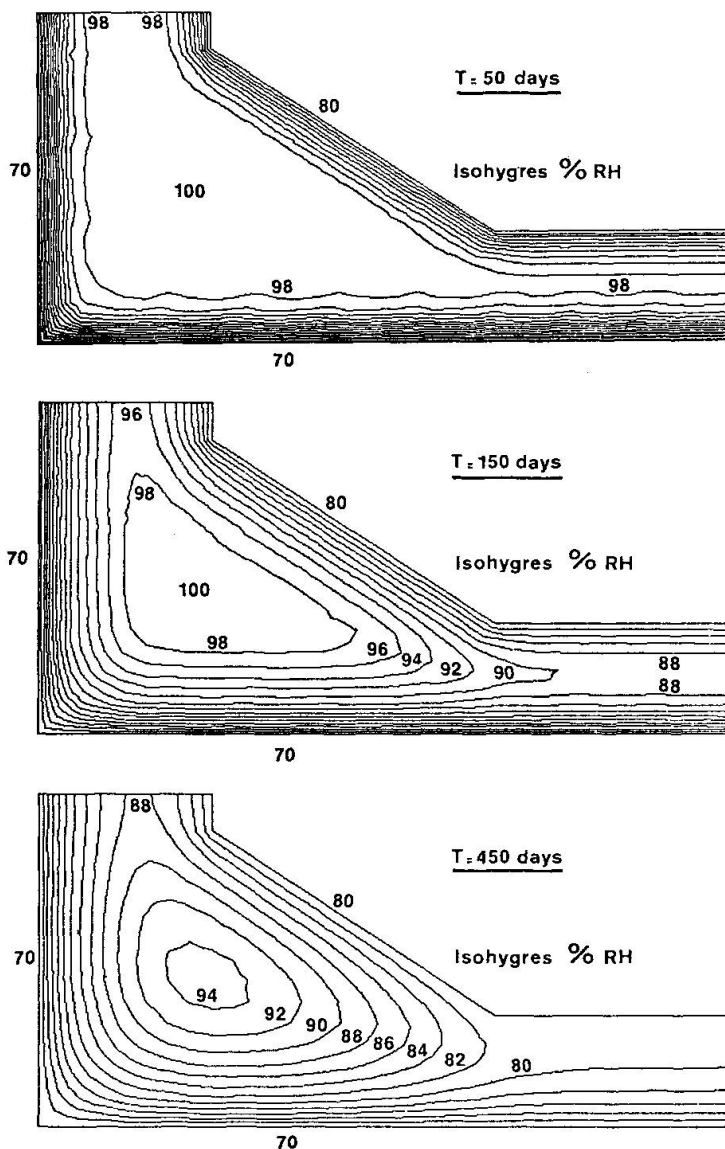

Figure 7 : The calculated moisture distribution at given times after demoulding.

In figure 7 the calculated moisture distribution at three different times after demoulding (duration of drying) are drawn by means of iso-hygres (lines of constant pore humidities).

After 50 days the main part of the corner is still wet. Near the surface there is a big gradient of humidity. This gradient results in tensile stresses which can overcome the tensile strength and thus introduce small cracks (tensile softening).

After 450 days the smaller parts of the cross-section have almost reached an equilibrium while the core of the corner just has started to dry.

This complex moisture distribution during drying will introduce so-called "drying induced bending moments" which again will influence the total deformation of the structure.

In figure 8 it is indicated how the calculated moisture and temperature distributions can be used in a routine analysis. By means of the derived materials laws these distributions can be translated into initial strains which have to be superimposed to the global state of stress. In this way it is possible to take into consideration the influence of moisture and temperature gradients on the overall response in structural analysis in a realistic way and based on actual materials behaviour.

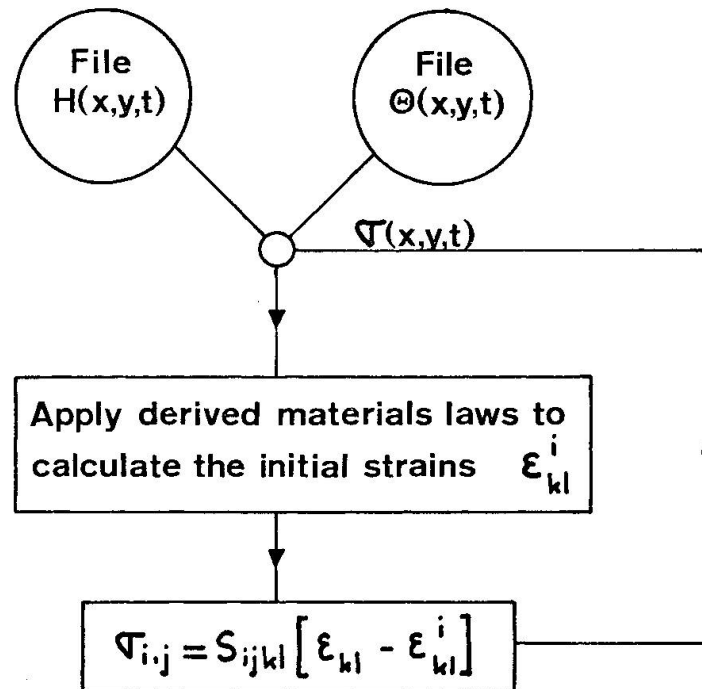

Initial strains: shrinkage  
 creep  
 tensile softening  
 thermal strains

Figure 8 : Flow-chart for a routine analysis.

#### 4. CONCLUSIONS

There exists a huge gap between structural analysis and materials science. It is possible nowadays to formulate materials properties in a complex and realistic way. By means of finite element analysis it is possible to describe the behaviour of composite materials such as concrete on the basis of elementary processes within the different components. Arbitrary structural members can be analyzed by using computer generated materials laws.

In this contribution an approach is outlined in which the materials parameters used in computerized structural analysis are derived by using numerical methods in materials science. This general concept will be further developed.

It is obvious that the method outlined in this contribution is not meant to be applied in every routine analysis. In all these cases where a detailed analysis is justified and needed, however, this approach can serve as a powerful tool. In a more general way this complex analysis enables us to point out and quantify the risk for mechanical damage in critical parts of a construction.

#### 5. REFERENCES

- /1/ Argyris, J.H., Warnhe, E.P. and Willam, K.J., "Berechnungen von Temperatur- und Feuchtefeldern in Massivbauten nach der Methode der finiten Elemente", Deutscher Ausschuss für Stahlbeton, Schriftenreihe, Heft 278 (1977).
- /2/ Anderson, C.A., "Numerical creep of structures", International Symposium on Fundamental Research on Creep and Shrinkage of Concrete, Lausanne, Switzerland (1980, to be published).
- /3/ Wittmann, F.H. and Roelfstra, P.E., "Total deformation of loaded drying concrete", Cement and Concrete Research, Vol. 10, 601-610 (1980).
- /4/ Roelfstra, P.E. and Wittmann, F.H., "Een rekenmodel ter bepaling van de totale tijdsafhankelijke vervorming van uitdrogend beton", Cement 6, 348-351 (1980).
- /5/ Wittmann, F.H., "Grundlagen eines Modells zur Beschreibung charakteristischer Eigenschaften des Betons", Deutscher Ausschuss für Stahlbeton, Schriftenreihe, Heft 290 (1977).
- /6/ Klug, P., "Kriechen, Relaxation und Schwinden von Zementstein", Dissertation, TU München (1973).
- /7/ Feldman, R.F., Fifth International Symposium on the Chemistry of Cement, Tokyo, Japan (1968).
- /8/ Pihlajavaara, S.E., "On the main features and methods of investigation of drying and related phenomena in concrete", State Inst. for Techn. Research, Helsinki, Finland, Ph.d.Thesis, Publ. No 100 (1965).
- /9/ Bazant, Z.P. and Najjar, L.J., "Nonlinear waterdiffusion in nonsaturated concrete", Mat. et Constr. 5, 3-20 (1972).

Leere Seite  
Blank page  
Page vide