

**Zeitschrift:** IABSE reports = Rapports AIPC = IVBH Berichte  
**Band:** 41 (1983)

**Rubrik:** Theme B: Navigational aspects

### **Nutzungsbedingungen**

Die ETH-Bibliothek ist die Anbieterin der digitalisierten Zeitschriften. Sie besitzt keine Urheberrechte an den Zeitschriften und ist nicht verantwortlich für deren Inhalte. Die Rechte liegen in der Regel bei den Herausgebern beziehungsweise den externen Rechteinhabern. [Siehe Rechtliche Hinweise.](#)

### **Conditions d'utilisation**

L'ETH Library est le fournisseur des revues numérisées. Elle ne détient aucun droit d'auteur sur les revues et n'est pas responsable de leur contenu. En règle générale, les droits sont détenus par les éditeurs ou les détenteurs de droits externes. [Voir Informations légales.](#)

### **Terms of use**

The ETH Library is the provider of the digitised journals. It does not own any copyrights to the journals and is not responsible for their content. The rights usually lie with the publishers or the external rights holders. [See Legal notice.](#)

**Download PDF:** 17.03.2025

**ETH-Bibliothek Zürich, E-Periodica, <https://www.e-periodica.ch>**



## **Theme B**

**Navigational Aspects**  
Aspects de navigation  
Navigationsaspekte

Leere Seite  
Blank page  
Page vide

## Marine Traffic Flows with Reference to Fixed Offshore Structures

Circulation maritime et structures fixes en pleine mer

Seeverkehr und befestigte Bauten im offenen Meer

**Elisabeth GOODWIN**  
Head of Department  
Polytechnic of North London  
London, UK

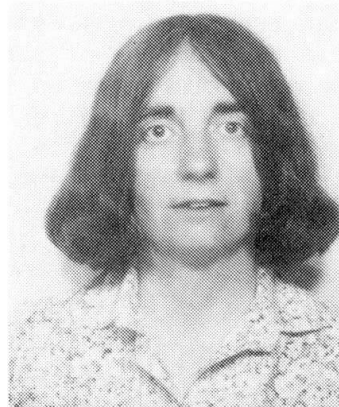

Elisabeth Goodwin studied Mathematics at the University of Nottingham followed by Statistics at the London School of Economics. She gained her PhD for a study of ship domains in 1975 and since then has been a coordinator of the Marine Traffic Research Unit based jointly at the City of London Polytechnic and the Polytechnic of North London.

### SUMMARY

This paper gives an overview of various aspects of marine traffic flows. The acquisition of data is discussed, followed by an account of various useful parameters which can be measured or evaluated in a study of marine traffic flows.

### RÉSUMÉ

Cette étude présente une vue générale de quelques aspects de mouvement de la circulation maritime. On discute comment les données sont acquises, et ceci est suivi d'une explication de quelques paramètres utiles qui peuvent être mesurés ou évalués dans une étude de mouvement de la circulation maritime.

### ZUSAMMENFASSUNG

Dieses Referat bietet einen Überblick über verschiedene Aspekte von Bewegungen des Schiffsverkehrs. Das Sammeln der Daten wird erörtert, und darauf folgt ein Bericht über verschiedene nützliche Parameter, die bei einer Untersuchung von Bewegungen des Seeverkehrs gemessen oder ausgewertet werden können.





## 1. INTRODUCTION

The study of marine traffic flows is still a relatively new area of concern. The work in Europe on this topic began seriously about the beginning of the 1970s although the Japanese had been pioneers in the work a few years before. For many centuries the principle of the freedom of the sea and in particular the freedom of navigation was recognised universally but various developments have caused people to question it closely. The increasing size of ships especially those used to transport cargoes such as oil, chemicals and liquid natural gas is one factor since various incidents have led to a growing awareness of the human and ecological consequences of even a minor accident at sea. Another aspect has been the continual economic demands for optimal efficient use of sea transport. However one of the most important factors has been the increasing tendency for structures to be built in the sea. The expansion in offshore resource exploration has resulted in considerable numbers of offshore structures being built all over the world and in European waters especially. Often these structures are in areas such as the North Sea where the available navigable sea-room was already restricted especially for the modern deeper-draught ships. Advances in engineering have resulted in bridges being built or planned in areas often of high shipping density with the effect again of reducing the available navigable sea-room. Single structures are being erected often for communication purposes. The presence of any structure in the sea is a potential hazard to shipping navigating in its vicinity and hence it is of importance to those responsible for placing the structure, those responsible for the safe navigation of vessels and society in general that the risks of accidents should be minimised. It has therefore become widely recognised that since conditions at sea are changing good information is needed on the behaviour of marine traffic under different circumstances. Until about ten years ago in Europe very little was known on marine traffic flows but now the position has changed considerably and it can now be hoped that any decisions affecting marine traffic navigation may be made causing the minimum of disruption to all parties concerned. This paper is concerned with the development of the study of marine traffic flows referring especially to the question of flows past fixed offshore structures.

## 2. ACQUISITION OF MARINE TRAFFIC FLOW DATA

### 2.1. General Considerations

The first stage in any traffic flow investigation must be the collection of suitable data. The primary considerations concerning the acquisition of this marine traffic flow data must be firstly the purpose for which the data are required, secondly the cost of acquiring it and thirdly the time scale over which it is required. In many areas little is known even about the daily volume of traffic passing through the region and if information only on a macro level such as this is required then relatively simple methods of data acquisition can be used. At the opposite extreme data are required on the exact positions of individual ships as they pass through an area and for this sort of information on a micro level complex methods of data recording are required.

### 2.2. General Traffic Density Surveys

Lloyd's Intelligence Service will supply a rough indication of the density of various types of merchant ship traffic passing through an area which is based on reported ship movements. A recent example of this for the Norwegian fixed offshore platforms in the North Sea is given in a paper by Skjong and Laheld [1]. No figures are however given for fishing vessels or traffic servicing an area such as oil rig supply ships, and so these figures must be obtained from other sources.

Another method used in a recent paper by Lewison [2] was to use the archive of reports from voluntary weather reporting ships. These ships regularly give their positions and meteorological reports which are compiled into a large data file held by one of nine meteorological offices round the world. The UK office for example holds data for the area  $40^{\circ}$ - $70^{\circ}$ N,  $20^{\circ}$ W -  $10^{\circ}$ E and it is possible to obtain the numbers of reports in different areas. There are widely differing opinions as to how representative the sample obtained this way is. For instance, there will probably be an underrepresentation of fishing vessels and there may also be inconsistencies in reporting so that some ships report more frequently than others. It is felt that particularly in heavy traffic density areas there may be a decrease in reporting because the ships' officers are too busy concentrating on the problems of navigating. However Lewison argues that the picture obtained gives very good values for relative traffic densities. It is thus possible to estimate the traffic density in a previously unsurveyed area based on the traffic density in another area for which better information is available.

A more direct approach for ascertaining traffic densities in any area is the use of aircraft to fly over the designated area. This method has been used frequently by the National Maritime Institute either using specially chartered commercial aircraft or planes of the RAF on training flights. Two typical examples of this approach are given in the reports of studies undertaken to estimate the risk of collision between ships and offshore structures for the Forties Field [3] and the Western approaches to the English Channel [4]. The NMI were able to arrange for the RAF to route several training flights over the particular region needed for the study. Photographs of the radar were taken during the flight and then the positions of vessels observed were plotted on charts and hence density distributions can be obtained. This method gives more direct information on location of ships within the given area although information on complete ship tracks is not usually available.

A fourth approach is that used by the Netherlands Maritime Institute [5] when they did a survey of ship routes in the North Sea and Dover Strait in 1977. Questionnaires were filled in by ships' masters as they entered and left each port around the North Sea and Dover Strait over a certain period of time. From this information a variety of ships' routes throughout the area were defined and a likely daily traffic volume assigned to each. Ships' officers and pilots who frequented the routes were asked to describe the likely course that a vessel on the route would take and as a result it was possible to plot the likely courses on a large chart of the area. It was then possible to locate points of convergence of routes and hence points of potential high traffic density. Typical speeds on routes were also estimated.

All these three methods are fairly expensive to use but most important of all provide only general background information on likely traffic densities. For instance in the fourth method which perhaps gives the most detailed information no knowledge is gained about the behaviour of traffic on the routes such as the lateral separation of vessels. They are perhaps useful for giving an indication of the likely overall traffic density in an area of interest.

### 2.3. Surveys of Marine Traffic Behaviour

Goodwin and Kemp in 1977 conducted a reasonably low cost survey of marine traffic in the Southern North Sea, an account of which has previously been published [6]. The purpose of this survey was to investigate the use ships made of available sea room and thus to establish whether ships tended to keep to a self-imposed routing structure when passing through a particular area and if so how wide were the routes. Other questions of interest might be the distribution of ships across the routes and the speeds throughout the area.



The survey was conducted from the m.v. 'Sir John Cass', research vessel of the City of London Polytechnic. The ship is mainly used for radar training in the Thames and has three radar screens for this purpose. It was thus possible to use one for survey work without hindering the navigation of the ship in any way. Ships' tracks were plotted directly from the radar PPI onto transparent sheets placed over a reflection plotter on the radar display itself. Direct plotting has the advantage that less subsequent processing of the data is needed and a further advantage is that any close encounter situation can be sorted out as it arises and lessens the chance of tracking ambiguities. However the method is only really suitable in areas of relatively light traffic density and when there is sufficient manpower available. This particular survey at the Sunk was conducted for a total of 20 hours over two days and in this period 94 ships giving an average of nearly 5 per hour were observed. The method can also be useful if the closest passing distance to a fixed structure is required. The area surveyed by Goodwin and Kemp contained two fixed objects, an old war time fort, the Roughs Tower and the Sunk lightvessel. The table below taken from a paper on collision risks for fixed off-shore structures by the same authors shows for ships passing within two nautical miles of each object the percentage having closest passing distances within each range.

Table 1 Closest passing distances for ships passing Roughs Tower and Sunk Lightvessel.

Closest Passing Distance (nautical miles)	Roughs Tower %	Sunk Lightvessel %
0 - < .25	16	25
.25 - < .5	5	20
.5 - < .75	16	16
.75 - < 1	26	13
1 - < 1.25	14	3
1.25 - < 1.5	16	9
1.5 - < 1.75	0	3
1.75 - < 2	7	11
Number of ships	43	56

The nature of the area was such that there were more routes passing the Sunk lightvessel than the Roughs Tower and additionally some ships needed to take on a pilot from the pilot cutter which cruised near the lightvessel. However the figures did suggest that there is a tendency for ships to pass closer to objects which are navigation marks than ones which are not, which in turn could affect the collision rate adversely for structures which are navigation marks.

The survey described above used direct plotting of ships' tracks for recording information. However in areas of higher traffic density or situations where there is less manpower available then the next simplest alternative is photography of the P.P.I. An advantage of the method is that all the targets in an area are captured simultaneously on a photograph whereas if the targets are plotted manually there is a spread of time as they are plotted in turn. The main disadvantage is that the photographs then have to be analysed to obtain ships' tracks and problems can arise in sorting out close quarter situations. Photography or the direct output of the information from an ARPA might help in this. Several researchers have used this method for different studies among them Goodwin [8] and Coldwell [9] both of whom took photographs manually at 3 minute intervals. This enabled visual watch to be kept simultaneously for ship identification and general background information such as changes in visibility. Goodwin used a stationary ship based radar and Coldwell a shore based radar. Experience with moving ship based radar for a particular area has been that interpretation of other ships' tracks in the area is not easy over a period of time. Kwik and Stecher [10] have done some



work from the bridge of a ship on a voyage from N.W. Europe to the Persian Gulf using an automatic movie camera to record the radar display. Their main results have been concerned with the movement of other ships relative to their own ship rather than relative to fixed objects. In the NMI study in the Forties field [3] photographs were taken of the radar on board one of the support vessels, to obtain a detailed picture of the traffic pattern around the installations in the oil field.

The Japanese who were the undoubted pioneers in the marine traffic survey area have used some interesting methods of time lapse photography to obtain ships tracks [11]. They have also used purely visual observation for surveys but this is only possible when the geography of the area permits overview of narrow waterways. This method is well suited for counting the number of ships crossing a given datum line and the ships can be identified in many instances by name as well as by type and length. However in poor visibility which is often one of the most critical conditions for marine traffic identification and even counting can become almost impossible. It is also difficult to estimate the range of passing from the observation point and speed is another parameter which cannot be estimated easily.

An example of another approach to detailed real-life marine traffic flow information is the completely automatic data acquisition system based on Digiplot used in the Hook of Holland Roads Survey [12]. The radar information is fed directly into a computer for processing, but there were often problems of tracking individual ships when ships pass close to each other particularly if they manoeuvre at the same time. Identification of ships is another problem. The positions of all ships in the survey area were recorded in the Rotterdam survey at 15 second intervals but even with this data frequency considerable work had to be done to sort out the individual tracks in the high traffic density in this area. There are likely to be more advances in the automatic acquisition of data but there are considerable costs attached at present in terms of both the hardware and software needed.

The preceding discussion has attempted to cover most of the major approaches to real-life marine traffic surveys which have been used in recent years when information about the behaviour of ships travelling through a given area is required. Although there have been some advances recently a more detailed account of the relative advantages and disadvantages of the different methods for real-life traffic surveys was given by Kemp and Holmes in a paper published in 1977 [13].

Real-life traffic surveys give authentic information but they have various disadvantages as well.

- They are expensive no matter which data collection method is used. The expense may be limited if the data are collected from a shore based station which perhaps only collects data as a secondary function. For instance the Channel Navigation Information Service [14] based near Dover produces a continuous record of marine traffic movements through the Dover Strait but there is still a need for subsequent processing. Many areas however can only be surveyed from a ship present in the area.
- Real-life surveys can be very time consuming. In the work done by the Marine Traffic Research Unit in London using the m.v. 'Sir John Cass' for data collection, a considerable proportion of time was spent in getting the ship to and from the appropriate spot. Additionally there is no guarantee that all the allotted time for a survey of this sort will produce useful results. If one were trying to study situations under which particular types of manoeuvres were made one might have to wait several hours between occurrences. There is also the very real risk that bad weather could cause abandonment of the survey anyway.





- There may be situations under which the collection of results could be at the worst hazardous and even at the best create problems because the survey ship is itself creating another obstacle which may affect the behaviour of other ships.
- Extraneous variation is another problem. It is not possible to control the majority of variables in a situation so that those which are of interest may be influenced by changes in those which are not. For example changes in weather conditions may make one day's survey results incompatible with those from another day.
- It is often not possible to monitor all the variables in which one is interested. Thus identification of all ships in the survey area may be difficult and hence it is impossible to get full statistics on type or size of ship.

#### 2.4. Data from Marine Radar Simulators

An alternative method of data collection is to observe the performance of navigators on marine radar simulators. This is very suitable as a means of studying the behaviour of mariners under different traffic flow problems such as navigation through an area which contains a bridge or fixed structures. Most nautical colleges have marine radar simulators for training mariners for navigation in fog when there is no chance of a visual lookout so considerable reliance has to be put on interpretation of the radar picture. Different situations can be replicated on the radar screen and it provides a valuable means of training mariners. The recent development of ship handling simulators with optical or television presentation of the view from the ship's bridge in addition to radar and other instrumental simulation increases the possibilities of research and training but at present there are not many available and it is quite a complicated task to change the scenario the mariner is faced with.

Changes of scenario on a radar simulator are comparatively more straightforward and several research projects have been carried out this way. Goodwin [8] in 1975 published a study on ship domains which will be discussed later in this paper, the data for which were collected from real-life surveys and from observations of the marine radar simulator at the City of London Polytechnic. The exercises which navigators do on this simulator are all of the discovery type, so that no briefing is given to the mariners before they undertake the exercise and all discussion is carried on afterwards. Thus mariners are not repeating actions they have been told to do only fifteen minutes earlier but are having to rely on their own sea-experience. This helps in ensuring fidelity which is the main worry over using the simulator. The navigator must be aware that he is in a simulated situation rather than in a real-life one and as a result may react in a different fashion. Ideally if one is using a simulator to give practice in a particular task then all features of the real situation which influence performances of that task should be represented. This includes features which may be detrimental to performance as well as those which assist it. A radar simulator may be made realistic in so far as the radar display may be exactly the same as those used on board ship but there is still a question as to whether this is sufficient or not. The simulation of a bridge at sea is one of the most difficult situations to achieve with a satisfactory amount of realism since there is not only the physical layout of the bridge which is needed but also the movement of the ship. Even the smell of salt may affect performance! In addition to these physical features the psychological features of stress and anxiety are difficult to simulate in any situation. The main stresses that arise are firstly those due to operating in a potentially dangerous environment, secondly the threat of hazards or sanctions if a wrong decision is made and thirdly time stresses. Since little is known about the effects of these stresses most researchers have concentrated on the validation of simulator results with those obtained in real-life surveys. The ship



domain results mentioned earlier suggested reasonable correspondence between the two data sources and this result was echoed in a study by Holmes [15] on the distances at which navigators first initiated manoeuvres. However in both of these studies the real-life data were collected in good visibility. A paper by Curtis and Barratt [16] in 1981 compared data from a radar display of the Dover Strait under thick fog conditions with data from a radar training simulator. They chose to compare the parameter of passing-track separation for ships in overtaking situations and again on this parameter reasonable agreement was found.

In addition to overcoming many of the disadvantages of real-life surveys suggested above there is one major advantage of using marine radar simulators which should be stressed. This is that standard situations can be produced in which all the variables of interest can be controlled and measured to within very close limits. These situations can then be replicated as often as required and hence it can be a very efficient means of data collection.

### 2.5. Mathematical Models

Another useful way of examining marine traffic problems is by the development of mathematical models. They can be extremely useful if one wishes to consider the effect of changing different parameters in a situation and one requires a reasonably quick answer. Models may be either analytical or digital depending on the degree of sophistication required. One of the earliest of these was built by Draper and Bennett [17] (1972) and was concerned with traffic flow in the Dover Strait under different routing systems. If one is interested in considering possible changes then there must be an objective measure for the end result of any changes. In this study the encounter rate between ships was taken as such a measure, an encounter being recorded when two ships passed within half a nautical mile of each other. All mathematical models however need information on marine traffic flows and it is not always possible to assume that results on the behaviour of ships in one area can be transposed to apply for another area. There is also the problem that once a model is altered to evaluate the effects of a change in traffic patterns, it has to be assumed that all other parameters stay constant. However in real-life this may not be true.

The modelling approach and the radar simulator can both be used however to examine experimental suggestions, whereas it is a very difficult and time consuming business to experiment at sea itself.

Degre and Lefevre [18] have built a computer simulation model for traffic in the English Channel and the results from this have been used as a basis for discussions for further routing schemes in the English Channel. Another large scale model which has been used as a basis for determining optimal traffic organisation schemes in the Hook of Holland Roads has been built by the Netherlands Maritime Institute in conjunction with the Royal Shell Laboratories Amsterdam and has been described in a paper by Spaargaren Tresfon [19]. The objective criterion used in this model for distinguishing between different alternative traffic schemes is described in a paper by Van der Tak and Spaans [20]. The criterion they develop gives recognition to such elements as traffic density, course and speed distribution of the traffic and the danger classes of the ships participating in the traffic, this latter being a special feature of this particular measure. Thus it is possible to assess the effect of keeping certain ships separate from the main traffic flow.

At Plymouth Polytechnic researchers there are building computer models which will simulate the manoeuvres of a ship with respect to land such as coastlines and narrow channels. An account of this model is given in a series of papers by Davis, Dove and Stockel [21], [22] and it clearly has applications when considering flows past fixed structures, or under bridges.



## 2.6. Questionnaire Methods

For the sake of completeness brief mention should be made of another means of obtaining information on the behaviour of marine traffic and that is by the use of questionnaires. They obviously provide a cheap method of collecting factual data but there may be problems in practice which can lead to biased results unless care is taken. Limited experiments at the City of London Polytechnic suggested that questionnaire replies on matters concerning the performance of navigators at sea tend to reflect what navigators would do in idealised situations and often bear little relationship to what is done in practice. However Davis, Dove and Stockel [21] in the work mentioned above used questionnaires for determining from mariners likely closest points of approach under different situations as an input for their model. However it was necessary to validate the results from real-life studies performed by other people so great care had to be taken with the results. Questionnaires are perhaps more suitable for obtaining factual information such as equipment on board or routing patterns as determined by the Netherlands Maritime Institute in 1977 [5]. The main problem here is ensuring a reasonable rate of return of the questionnaires and that bias does not creep in because the non-response is all from one type of ship say.

## 3. USEFUL PARAMETERS OF MARINE TRAFFIC FLOWS

### 3.1. Typical Parameters

The previous section has attempted to describe the major methods used for data acquisition and at the same time has described many of the parameters which are of interest. Some of the more important ones are general traffic density, size and type of ships, speed distribution, arrival and departure distributions from an area, routing patterns and lateral distributions across routes, and manoeuvre behaviour between two ships or one ship and a fixed obstacle. As mentioned in the section on modelling the study of an area is usually concerned with the measurement of risk to shipping existing in the area and this is perhaps the most important secondary parameter to be estimated from the study. The second part of this paper will therefore be concerned with this measurement of risk.

### 3.2. Encounter Rates

Most of the work in marine traffic flows has been concerned with the measurement of collision risk between two moving vessels. A collision is usually the result of a variety of circumstances and it is often the combination of several factors in the final stages of the event that result in the accident. Much work is going on into the determination of these factors notably by authors such as Kemp [23], Cockcroft [24] Drager [25]. Some of the factors are essentially human factors which are very difficult to monitor and yet others can be characterised as mechanical breakdowns. Although a collision with a fixed structure involves one moving ship only it is clear that many of the basic principles of investigation and analysis for collisions between ships will be useful in the former case.

It has long been considered that a reduction in the collision rate might be helped if a reduction in the encounter rate for ships could be achieved. This has long been a principle in the air in the maintenance of air separation standards, typical papers on this being those by Reich in 1964 [26] & [27]. Lewison [28] in 1978 investigated the relationship between encounter rate and collision rate for marine traffic in the Dover Strait, but there are always problems in making inferences based on numbers of collisions because they are relatively so rare. The numbers of encounters in an area do obviously give

an indication of the average number of potentially complicated incidents a navigator is likely to experience in any particular area.

An encounter may be said to have occurred when two ships come within a specified distance of each other. However if the measure is to be meaningful as well as objective then the choice of specified distance is very important. One approach is to use a fairly arbitrary encounter distance such as 0.5 n.miles as taken by Barratt [29] (1973) in his work on encounter rates in the Dover Strait. An encounter between two ships under this definition is said to have occurred if a second ship enters a circle of radius 0.5 n.miles centred on the first ship. A different choice of radius such as 0.4 n.miles would produce different results. This may not matter too much if one is comparing the situation in a given area under different traffic organisational schemes but is not very satisfactory if one is looking at comparisons between areas. The major disadvantage is however that the choice is not based specifically on a navigator's own behaviour and if at a later stage it is hoped to persuade navigators to accept decisions based on measures of encounter rate then realism is important. The second approach therefore for the choice of encounter distance is to base it on ship domain theory.

### 3.3. Ship Domain Theory

A ship domain may be thought of as the effective area around a ship which a navigator would like to keep free with respect to other ships and stationary objects. This particular definition was proposed by Goodwin [8] (1975) and was developed from some initial work of Fujii and Tanaka [11] in Japan. The work by Goodwin has been extensively used in open sea situations but in 1982 Coldwell [9] extended the theory to narrow channel situations.

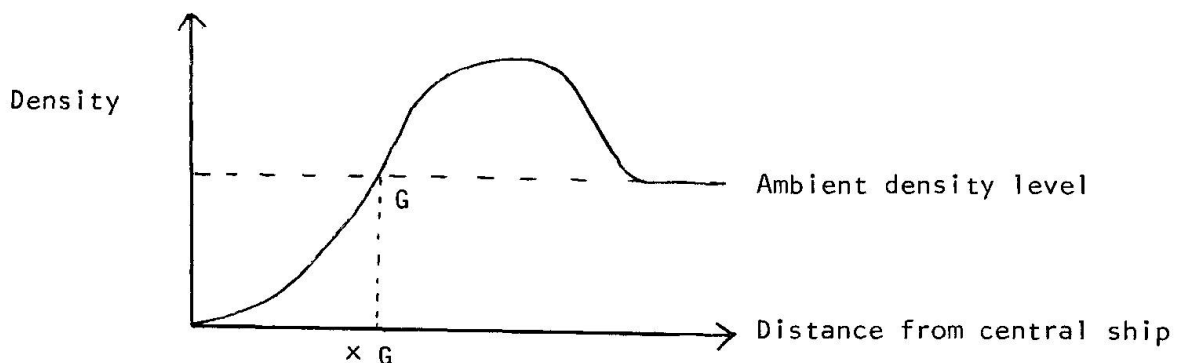

Fig. 1 shows a typical curve obtained if one were to plot the density of shipping around a central ship against the distance from the central ship. In the immediate vicinity of the central ship there are hardly any if any other ships, but as the distance increases from the central ship the density rises and then falls again until the overall density level of the area is reached. This is because ships take action if necessary to avoid coming too close to another ship. In practice one would not obtain the diagram illustrated in Fig. 1 at any one point in time but it can be built up by superimposing a succession of time points and also a succession of different ships. Authors vary as to the definition of the domain boundary but Goodwin has taken point  $G$  in the diagram, the point at which the density curve first reaches the ambient density level. It was possible to establish a straightforward objective method of locating the domain boundary and results were obtained for a number of different factors that it was felt might influence the size and shape of the domain such as speed, size of ships, traffic density etc. Data sets from both the marine radar simulator and real-life surveys in the Southern North Sea described earlier in this paper were used to determine



the results and these are given in Table 2.

Table 2 : Domain boundaries in Nautical Miles for different Sea Areas by Sector

Sea Area	Sector 1	Sector 2	Sector 3
Simulator data : Dover Strait	0.8	0.8	0.1
Simulator data : Gibraltar Strait	1.5	1.4	0.6
Simulator data : Open Ocean	2.4	2.4	0.9
Survey data : S.North Sea	0.9	0.7	0.5
Survey data : Hook of Holland Roads	0.3	0.3	0.3
Survey data : S.North Sea, buoys	Circle radius 0.1 n.mile.		

At sea the responsibility for collision avoidance depends on the relative bearing of two ships, hence the domain boundary was evaluated separately for different sectors. Taking the direction of motion of the central ship and measuring an angle  $\theta$  clockwise from this line then Sector 1 is defined as  $0 \leq \theta \leq 112.5$  (starboard bow), Sector 2 as  $247.5 \leq \theta < 360^\circ$  (port bow) and Sector 3 as  $112.5 < \theta < 247.5$  (astern). The Hook of Holland Roads results also given were evaluated in a separate study reported by Goodwin in 1978 [30] but were based on the data set described by Van den Hoed [12], already mentioned.

It is also possible to define a domain around a stationary object such as a buoy or fixed structure. In Fig. 1 the stationary object would be placed in the position of the central ship and tracks of ships with respect to it analysed. The survey in the Southern North Sea suggested that a circular area of radius 0.1 n.miles around a buoy is the area of clear water which navigators of a typical ship like to keep free. As a buoy has no motion of its own it is not surprising that the results are much smaller than for two ship encounters. The domain of a fixed structure is likely to be larger than that for a buoy, but may also depend probably on traffic density where the domain for a buoy has been shown to be fairly constant in different traffic areas. Fujii [31] 1977 has also postulated the existence of a hard core domain which represents the lowest limits to which a ship domain can be compressed. Evidence for this in further work by Goodwin suggests that the circular area of 0.3 n.miles found in the Hook of Holland Roads may represent average dimensions for a hard core domain for typical shipping in North West European Waters.

Abdelgalil [32] has approached the definition of a domain from the hydrodynamic effects of being close to other ships or structures and this is obviously another useful approach.

Having established the size and shape of a domain it is possible to use it the basis of a definition of an encounter. The navigator would consider himself to be in an encounter situation if there was another ship in his domain or if his ship encroached the domain of a fixed structure.

The use of a domain as a basis for encounter rates has been adopted in the various models described earlier by Degre and Lefevre [18] and Davis, Dove and Stockel [21], [22]. In the work by Van der Tak and Spaans instead of using average domain sizes for an area, different domains for different classes of ship have been calculated. This might also be a useful approach in work on fixed structures as size of ship is very important in potential impacts, but also the overall consequences of an accident involving an LNG carrier or passenger ship are far greater than one involving say a general cargo ship. The economic consequences of accidents to different types of ships is being studied at present by Giriakis, another member of the Marine Traffic Research Unit and analyses of this will be available soon.

### 3.4. Weighted Encounter Indices

Various authors are working on suitable indices to establish the level of danger in any area. Goodwin [30] in 1978 developed an Index of Orderliness which counted future encounters as well as actual encounters with a decrease in weighting depending on the period ahead for the potential encounters.

The maritime risk criterion number of Van der Tak and Spaans [20] has already been mentioned. Another approach whereby the number of actual encroachments of the domain were related to the number of potential encroachments was described in a paper by Goodwin & Loh [33] (1981). Lamb, working under the auspices of the Marine Traffic Research Unit is developing this work much further and has defined an index based on the manoeuvres needed to avoid a collision.

Another approach is that of Lewison [2] who has developed a Fog and Collision Risk Index using data from voluntary reporting ships as described earlier. The weighting of encounter rates by external factors such as visibility is obviously another interesting idea. This has been used in a study of the Forties Field by the National Maritime Institute [3].

All of these measures have been developed for the ship-ship collision situation to provide comparisons between different areas. It would be fairly straightforward to adopt them for the ship-fixed structure collision situation and thus enable relative risks for existing and planned structures to be evaluated.

### 3.5. Related Work

As a concluding section it is perhaps worth summarising briefly some of the alternative approaches to obtaining estimates of collision risks for fixed structures which have been used by some of the authors mentioned throughout this paper as a development of the work on marine traffic flows. Lewison [34] (1978) gives four methods in a paper on the North Sea Offshore Installations. These are (i) use of domain infringement, (ii) comparison with ship collision rates, (iii) infringements of safety zone around installation and (iv) comparison with collision rate with other fixed objects. Goodwin and Kemp [7] (1980) have also used similar methods to Lewison's (i) and (iv) but have used another method based on the probability of groundings. Barratt [4] (1981) has used the final three of Lewison's methods for estimating potential collision risk in the English Channel and the Western Approaches.

## 4. CONCLUSIONS

This paper is intended as an introduction to some of the navigational aspects of ship collisions with fixed structures. There are however many navigational aspects which are outside the scope of this particular paper, such as the provision of equipment on the bridge of the ship.

The paper falls into two main sections. Firstly an attempt has been made to discuss the variety of methods which have developed over the last ten years for the collection of data on marine traffic flows. It has not been possible to give a completely comprehensive account but the intention has been to illustrate the work of some of the main research groups in this area. The second part is concerned with the analysis of these data and again the intention has been to illustrate some of the ideas which have been discussed over the past few years which could be used to investigate further the problem of ship collision with bridges and offshore structures.



## REFERENCES

1. SKJONG, R and LAHELD, P., Probability for ship collisions Conference on Norwegian Petroleum Directorate's guidelines for safety evaluations of offshore platform concepts. Lillehammer Norway 1982.
2. LEWISON G.R.G., The estimation of collision risk for marine traffic in U.K. waters. *Journal of Navigation* 33,3. 1980.
3. BATCHELOR, K.S., CHALK, R.F., and LEWISON G.R.G., Survey of shipping in the Forties field 1978., NMI R52., 1979.
4. BARRATT, M.J., Collision risk estimates in the English Channel and Western Approaches. NMI R115, 1981.
5. Survey of ship routes in the North Sea and the Dover Strait. Netherlands Maritime Institute 1977.
6. GOODWIN, E.M. and KEMP, J.F., A survey of marine traffic in the Southern North Sea. *Journal of Navigation* 30,3. 1977.
7. GOODWIN, E.M., and KEMP, J.F., Collision risks for fixed off-shore structures, *Journal of Navigation* 33,3. 1980.
8. GOODWIN, E.M., A statistical study of ship domains. *Journal of Navigation* 28,3, 1975.
9. COLDWELL, T.G., A marine traffic study in the Humber seaway. CNAA PhD. thesis. City of London Polytechnic. 1982.
10. KWIK, K.H. and STECHER, W., Sea traffic recordings from the English Channel up to the Persian Gulf. Marine Traffic Systems Symposium The Hague 1976.
11. FUJII, Y., and TANAKA, K., Traffic capacity, *Journal of Navigation* 24,4 1971.
12. VAN DEN HOED, W.C., The use of a shipborne automatic radar plotter for recording marine traffic. Marine Traffic Systems Symposium, The Hague 1976.
13. KEMP, J.F., and HOLMES, J., Marine traffic survey methods : data collection and processing in Mathematical aspects of marine traffic ed Hollingdale S.H., Academic Press. 1977.
14. EMDEN, R.K.N., Traffic Separation-what next? *Journal of Navigation* 31,2. 1978.
15. HOLMES, J.D., A statistical study of factors affecting navigation decision-making. *Journal of Navigation* 33,2. 1980.
16. CURTIS, R.G., and BARRATT M.J., The validation of radar and simulator results. *Journal of Navigation* 34,2. 1981.
17. DRAPER, J., and BENNETT, C., Modelling encounter rates in marine traffic flows with particular application to the Dover Strait. *Journal of Navigation* 25,4. 1972.
18. DEGRE, T., and LEFEVRE, X., A simulation model of marine traffic in the Dover Strait. Marine Traffic Services Symposium Liverpool 1978.
19. SPAARGAREN K., and TRESFON R., Observation related port approach traffic simulation OR PATS. Marine Traffic Services Symposium Liverpool 1978.
20. VAN DER TAK, C., and SPAANS, J.A., A model for calculating a maritime risk criterion number. *Journal of Navigation* 30,2. 1977.
21. DAVIS, P.V., DOVE, M.J., and STOCKEL, C.T., A computer simulation of marine traffic using domains and areas. *Journal of Navigation* 33,2 1980.



22. DAVIS, P.V., DOVE, M.J., and STOCKEL, C.T., A computer simulation of multi-ship encounters. *Journal of Navigation* 35,2. 1982.
23. KEMP, J.F., Factors in the prevention of collisions at sea, CNA A PhD thesis, City of London Polytechnic, 1974.
24. COCKCROFT, A.N., The circumstances of sea collisions, *Journal of Navigation* 35,1 1982.
25. DRAGER, K.H., Course relationships of collisions and groundings. Det Norske Veritas Report No.81-0097 1981.
26. REICH, P.G., A theory of safe separation standards for air traffic control. RAE Technical report No. 64041. 1964.
27. REICH, P.G., An analysis of planned aircraft proximity and its relation to collision risk with special reference to the North Atlantic Region. RAE Technical report No. 64042 1964.
28. LEWISON, G.R.G., The risk of a ship encounter leading to a collision. *Journal of Navigation* 31,3 1978.
29. BARRATT, M.J., Encounter rates in a marine traffic separation scheme. *Journal of Navigation* 26,4 1973.
30. GOODWIN, E.M., Marine encounter rates. *Journal of Navigation* 31,3 1978.
31. FUJII, Y., et al. The behaviour of ships in limited waters. Permanent International Association of Navigation Congresses Leningrad 1977.
32. ABDEL GALIL, E.M., Shipping casualties and ships domains. Marine Traffic Services Symposium Liverpool 1978.
33. GOODWIN, E.M., and LOH, A.B., Establishment of a danger criterion for marine traffic flows. Symposium of vessel traffic services Bremen 1981.
34. LEWISON, G.R.G., The risk of ship/platform encounters in UK waters NMI R 39 OT-R-7728 1978.

Leere Seite  
Blank page  
Page vide

**Offshore Structures and Navigation Risk Management**  
Constructions offshore et gestion des risques de navigation  
Offshore-Bauten und Bewältigung von Navigationsrisiken

**Joseph J. PUGLISI**  
Managing Director, CAORF  
U.S. Maritime Administration  
Kings Point, NY, USA

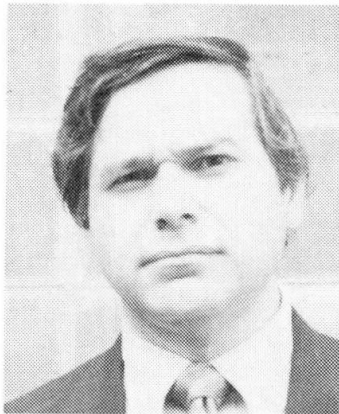

Joseph J. Puglisi, born in 1944, received his Masters Degree in Electronic Engineering and Computer Science from New York University and completed post graduate work in a Doctoral Program from Brooklyn Polytechnic Institute. For 12 years since 1970, he has directed projects in computer simulation, electronic navigation and communications at CAORF and the National Maritime Research Center, Kings Point, New York.

**Justus R. RIEK**  
Mrg. of Res. and Experim.  
CAORF  
Kings Point, NY, USA

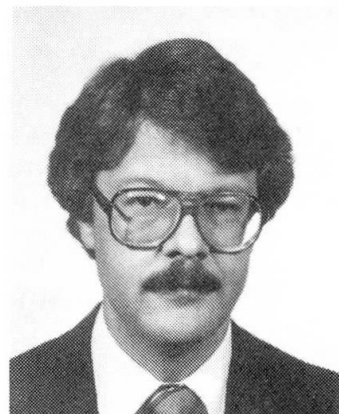

Dr. Riek, born in 1943, graduated from the University of North Carolina at Chapel Hill and spent 4 years in the U.S. Air Force as a meteorologist. He received his Ph.D. in Computer Science from Syracuse University in 1974 and joined CAORF. He is currently in charge of all research and operations activities.

#### **SUMMARY**

As oil drilling activities intensify in the coastal waters of the world, the potential for interference with merchant vessel traffic increases. The U.S. Maritime Administration, Office of Research and Development, has developed a comprehensive guide to marine risk management which is described briefly. Finally, a description is given of a specific risk management project, utilizing the Computer Aided Operations Research Facility (CAORF), to investigate the interactive effects of ship traffic and oil drilling activities of the Santa Barbara Channel in California.

#### **RÉSUMÉ**

Avec l'intensification des activités de forage de puits de pétrole dans les mers littorales dans le monde entier s'accroît la possibilité d'interférence avec le trafic de la flotte commerciale. L'administration américaine de la marine marchande a élaboré une instruction détaillée sur la gestion de risques de navigation: celle-ci est brièvement décrite. Un projet spécial de gestion de risques, à l'aide de l'ordinateur, est présenté pour le cas du forage de puits de pétrole dans le canal Santa Barbara en Californie.

#### **ZUSAMMENFASSUNG**

Gleichzeitig mit der Intensivierung der Oelbohrungsaktivitäten in den Küstengewässern der ganzen Welt, nimmt die Möglichkeit eines Eingriffes in den Handelsverkehr zu. Die Schifffahrt-Verwaltung der USA, hat eine umfassende Anleitung zur Bewältigung der Navigationsrisiken ausgearbeitet, welche kurz beschrieben wird. Abschliessend folgt eine Beschreibung eines besonderen Projekts zur Bewältigung von Risiken, in dem der Computer dafür verwendet worden ist, die Auswirkungen der Oelbohrungsaktivitäten auf den Schiffsverkehr des Santa Barbara Kanals in Kalifornien zu untersuchen.





## 1. INTRODUCTION

Political and economic forces continue to place pressure on society to permit development of offshore energy resources. There is no longer any real question about whether to permit such development, but only how much and under what conditions. Questions about energy development raise obvious questions of risk acceptance. Thus, the search for oil/gas in the oceans of the world is becoming very much concerned with risk management.

In recognition of this fact, the U.S. Maritime Administration has developed a general strategy for dealing with risk in a marine environment. This paper will discuss some of the more salient aspects of risk management, and give a brief description of the Maritime Administration approach. Finally, we shall present the more important results of a risk management project conducted for the state of California which studied the interactive effects of offshore drilling activities and merchant ship traffic, utilizing the CAORF simulator.

## 2. MARITIME RISK MANAGEMENT

As technology has advanced in sophistication and magnitude of consequences, people have become more interested in formal risk management. The public has taken a greater interest in those activities (eg. the LNG terminal) which are likely to affect their quality of life. Government, responsive to the demands of an aroused public, has begun to require that more comprehensive planning (eg. Environmental Impact Statements) take place in order to insure that tragic "surprises" do not occur. Private industry, with ships costing \$100 million, is keenly interested in protecting that investment from all forms of risk. Everyone is interested in risk management. Encouraged by legislation in the form of Port Safety and Tank Vessel Safety Act of 1978, the National Maritime Research Center has moved to formalize this interest in the area of maritime risk [1].

The Port Safety and Tank Vessel Safety Act of 1978 directly addresses the requirements for a comprehensive management and mitigation program for marine hazards and risks. There are, however, strong guidelines as to what should constitute the basic tools to be employed in such a risk management program. Since human error accounts for a large percentage of marine accidents, the U.S. Coast Guard has not seen fit to rely on mathematical models for rule making. In considering the merits of probabilistic safety analysis, the U.S. Coast Guard is on public record that such an approach is not a sufficient basis for the specification of maritime safety procedures. Given the strong deterministic requirements of the above Act, it was natural for an agency such as the Maritime Administration to specify a set of guidelines for the conduct of risk management using as its primary analytical tool, the Computer Aided Operations Research Facility (CAORF).

CAORF is a sophisticated ship simulator which has become increasingly involved in marine transportation risk management relating to energy development. Intensive application of simulation techniques to investigate the human element in shipping has provided answers to questions involving LNG terminal siting, offshore energy development, tanker safety, and the modification of shipping patterns in response to port/terminal development. These investigations have developed reliable information in support of Environmental Impact Statements and helped define safe operating plans for energy-related terminals and ships.

It is important that simulation of the total environment surrounding the deck watch officer occur. Thus far, numerical modeling of the complex interactions between man-ship-environment using digital simulation has proved inadequate. From a mathematical point of view, human performance modeling with its complex feedback control loops has proved to be an intractable problem, producing incomplete and often erroneous results. While other forms of study may provide valuable insight into various restricted aspects of problems and solutions, the ultimate test of validity (short of the real world) is the simulation of problems in a realistic and controlled environment in which all important variables can be systematically manipulated to observe the effect upon human performance.

### 2.1 Maritime Risk Management Procedures

It is important to point out that the word "risk" is used here in a somewhat restricted sense. Risk management refers to the identification and mitigation of risks of physical damage to life, property or the environment which may occur as a result of marine casualty or the cumulative result of normal marine operations. Because the definition of what is "valued" can vary both as a function circumstance and point of view, it is the responsibility of various user agencies to translate the risks of such physical damage into "dollar values" or a degradation of the "quality of life." Even if such translation into objective utility is

not entirely practical, the performance of these risk identification and mitigation efforts are useful in a relative sense, to order different situations/consequences as to relative risks and relative costs/benefits.

### 2.1.1 Approach

Despite the breadth and number of different aspects in a comprehensive maritime risk management program, a structured approach can be defined and may be applied in whole or in part to any marine project. Such projects may range from the establishment of a new route for shipment of a particular cargo to the construction of an entire port facility. Situations requiring risk management measures may vary from the effect of a single offshore oil drilling platform to the establishment of a Vessel Traffic Service in a busy harbor. In accordance with the basic concepts of risk management, all risks can be categorized into the three basic groups of risks to people, risks to equipment and risks to the environment. The overall risk management program approach involves three steps:

- (1) Definition of applicable risk areas – in this step, the identification and categorization of potential risk areas associated with a maritime project leads directly to a structure for the risk management program required.
- (2) Application of appropriate risk analysis techniques – for each risk area, appropriate risk analysis approaches are applied for the purpose of quantifying the risks and investigating appropriate risk mitigation measures. Techniques other than CAORF simulation are used as a form of supplemental analysis.
- (3) Determination of applicable risk mitigation measures – this consists of the definition of vessel or facility design factors, hardware added, or procedures specified for the management or mitigation of the associated risks.

We shall discuss each of these three steps in more detail.

### 2.1.2 Risk Categories and Program Structure

The identification and categorization of risk areas associated with any project are the initial steps which must be taken for the purpose of establishing a risk management program. One simply creates a comprehensive list and then decides which are to be retained and which are to be discarded. In many cases, the establishment of an Advisory Group to oversee the progress of the risk management project is an effective step. The Advisory Group should be made up of representatives of all the different groups which have an interest in the program. The Group can be especially helpful in the beginning by participating in the categorization of areas of risk and establishing the program structure. Such participation by a representative Group will help insure the completeness of the risks to be studied and will minimize the disruption which may occur later on if special interests attempt to modify the scope of the project underway. By involving people at the beginning and allowing them to help shape the program, acceptance of the risk mitigating measures will be facilitated. When the final recommendations are made, there will be no "surprises" on the part of regulatory agencies, public groups or commercial interests. The Advisory Group can also provide a forum in which communication between different special interest groups can resolve disagreements which might otherwise threaten the ultimate goals of the risk management program.

To get one started, the following very general risk categorization is recommended. The final list of categories will, of course, be a function of the specific project under consideration and the resources to accomplish the study.

- I. Risks to life
  - A. Project personnel
    1. Shipboard
    2. Facility operating or related support
  - B. Public
    1. Residents
    2. Traffic or other transient
    3. Visitor or recreational
      - a. Land (beaches)
      - b. Boating (pleasure/fishing)
- II. Risks to property
  - A. Ownship
    1. Internal
    2. Interaction with other vessels
  - B. Other vessels (project related vessels)





- C. Terminal
  - 1. Onshore components
  - 2. Offshore components
- D. Other facilities
  - 1. Public
  - 2. Industrial
- III. Risks to marine environment
  - A. Terrestrial – damage from casualty
  - B. Oceanographic
    - 1. Oil spill
    - 2. Chemical release
    - 3. Creation of navigation hazard
  - C. Atmospheric
    - 1. Emissions
    - 2. Chemical release
  - D. Long term environmental impact
    - 1. Normal operations
    - 2. Casualty occurrence

Finally, this first step of the risk program development should also include

- a review/evaluation of existing agency authorities, legislation and regulation
- a study of available and in-place mitigation measures and resources for prevention and containment of potential casualties
- an evaluation of existing contingency and response plans/procedures.

### 2.1.3 Analysis Approaches and Methodologies

In examining and quantifying the various types of risks in a maritime risk management program, a number of types of analysis are necessary. To carry out these types of analysis, various analytical techniques may be applied. Six basic types of analysis which are applicable in a comprehensive maritime risk management program are briefly described below. Further information on each may be found in [1].

#### (1) Personnel and Public Risk Exposure Analysis.

The object of this analysis is to define the type and levels of risks to which maritime project personnel and the general public are exposed due to the presence or operation of the maritime project. It requires a description of the vessel, facility or operation in the preliminary design stage, a description of operating procedures and a description of planned safety/containment features. The primary output from this type of analysis will be

- contingency procedures
- safety/emergency equipment
- monitoring, detection or warning systems
- vessel or facility design factors such as fire prevention, retarding or fighting systems, escape routes, etc.

#### (2) Simulation Analysis.

Simulation is generally performed in one of two ways – a) using fast-time digital computers solving hydrodynamic equations of motion to drive ship models under the control of various types of auto-pilots b) using the CAORF simulator to conduct elaborate investigations into the relevant aspects of human performance. Fast-time simulation may be useful for the study of less critical problems in which a high degree of fidelity is not required, or as a screening device to perform a preliminary assessment of risk inherent in problem situations before placing those most critical on the CAORF simulator for a more comprehensive investigation.

#### (3) Casualty Analysis.

The object of this type of analysis is to investigate the cause and effect relationship in a set of casualty scenarios postulated as feasible in the marine operation under consideration. For ship operations the initial types of vessel casualties ordinarily postulated are

- internal system failure
- fire/explosion
- grounding
- ramming
- collision



Generally conducted in the form of a fault-tree analysis, the chief output of this analysis is the development of a broad spectrum of potential casualties together with their probable cause and effects. See [2] for an elaborate example of such a procedure in a maritime setting.

(4) **Safeguard Analysis.**

This deals with human deliberate actions to damage or destroy important marine assets. Its primary objectives are to

- evaluate susceptibility to sabotage
- estimate consequences
- recommend countermeasures

Most maritime projects already in existence will not have been designed to cope with any well organized threat. Maximum protection to such facilities may be limited to added hardware or procedures since the basic design factors are already in place. The key to the procedure is “threat definition.” New facilities of a critical nature can be “hardened” during the design phase to minimize the risk due to identified threats. The analysis will depend upon the nature and criticality of the maritime project under consideration. Some of the more obvious mitigation measures will likely include

- physical barriers
- area and underwater surveillance devices
- specialized communication systems
- security escorts for ships
- traffic control
- damage control equipment
- personnel screening
- visitor clearance and control
- guard training/use of weapons

(5) **Salvage Analysis.**

Salvage analysis proceeds from the delineation of one or more casualty scenarios. The object of the scenario definition and analysis is to identify potential casualty outcomes and the associated requirements for contingency planning, salvage actions, equipment, personnel and their training.

(6) **Environmental Effects Analysis.**

The purpose of this analysis is to quantify the effects of maritime operations on the terrestrial, oceanographic and atmospheric environment in both the short-term and long-term.

#### **2.1.4 Mitigation Measures**

The essential product of any maritime risk management program is to create a list of mitigation measures to be applied as appropriate to eliminate or minimize physical hazards. All candidate measures will fall into one of the three categories of design, hardware or procedures. While the specific measures resulting are likely to be a function of the nature of the project evaluated, the types of risks considered and the nature of the analyses applied, a general listing of likely mitigating measures can be given. These would include

- requirements for specific navigation, communication and safety equipment
- control of vessel movement
- determination of port, port access and vessel operating procedures
- designation of fairways and traffic separation schemes
- definition of hazardous cargo handling procedures
- establishment of safety zones
- establishment of pilotage, manning and training standards
- regulation of vessel design factors

### **3. SANTA BARBARA CHANNEL RISK MANAGEMENT PROGRAM**

Oil and gas reserves are known to exist under the Santa Barbara Channel off the coast of southern California. This risk management program was conducted to determine means to minimize risks to facilities and the environment resulting from offshore oil and gas recovery activities. Since the entire project is described in detail in [3], we shall present only a brief description of many of the more routine aspects of the investigation.

#### **3.1 Advisory Groups**

An Advisory Group was formed to guide the work on the project. It included representatives from the U.S. Coast Guard, local shipping associations, oil companies, environmental groups and project personnel from CAORF and the California Coastal Commission for whom the program was being conducted. The par-



icipation by the Coast Guard was deemed particularly important in view of the probable regulatory implications of program recommendations. With the Coast Guard in the Group, the facilitation of rule making was thought to be enhanced.

### **3.2 Background Data**

Worldwide and nationwide vessel and offshore oil development casualty data were assembled. The data indicate that vessel to vessel collisions, ramming of offshore structures and on-board vessel casualties are the primary risk areas. Worldwide, vessel groundings are a problem, but the nature of the Santa Barbara Channel minimizes the probability of this risk. Of all collisions, rammings and groundings, 78 percent have occurred either at night or under conditions of limited visibility. Human error, due to inattention or to circumstances requiring decision and action out of the ordinary, was found to be the cause of the vast majority of casualties.

Finally, environmental data for the channel were assembled to permit selection of realistic wind, current and visibility conditions in the course of subsequent analysis.

### **3.3 Vessel Traffic and Oil/Gas Development Projections**

To establish the likely levels of both vessel traffic and offshore drilling activities, projections were completed in both areas. Based upon west coast port activity and commodity flow projections as well as probable growth in ship sizes, vessel traffic through the channel has been projected from the current total of 25 ships per day to a nominal of 29 and a maximum of 43 ships per day by the year 2000. Thus, one of the basic assumptions under which this study was conducted is that there will be no dramatic increase in the flow of merchant ship traffic through the Santa Barbara Channel during the next 10-20 years.

Using information from the Department of the Interior Lease Sales and the state-of-the-art in oil drilling, areas and densities of likely drilling, construction and production have been projected through the year 2000. By that time, the nominal number of new platforms in production in the channel will be 29, with the maximum number projected at 47. Due to the locations of potential oil reserves, there are numerous desirable locations for exploratory drilling and production platforms near or within the Traffic Separation Scheme.

### **3.4 Potentially Applicable Risk Management Measures**

There are a number of risk mitigation measures currently in effect in the Santa Barbara Channel. Primary among these is the passive Vessel Traffic Separation Scheme (VTSS). U.S. Coast Guard surveys have shown that compliance with the voluntary VTSS is virtually 100 percent for merchant ships transiting the Channel. Numerous other risk mitigation measures are possible, ranging from additional safety fairways to a positive vessel traffic position monitoring system and active Vessel Traffic Service (VTS) by the U.S. Coast Guard. However, it was one of the basic assumptions of this study that the VTSS would remain in its present location with no modifications to its existing geometry.

A detailed discussion of existing and potentially applicable risk management measures is contained in [3]. It is from this spectrum of choices that the recommended Channel risk management measures have been selected. In particular, constraints are recommended on the placement of temporary or permanent structures proximate to paths of vessel traffic.

### **3.5 Generation of Risk Exposure Scenarios**

Based on the oil-related development and vessel traffic projections described above, a number of situations were developed representing conditions of vessel/structure exposure to hazard. These situations formed the basis for the analytical and simulation experimental work carried out, and are:

1. Drilling rigs (or ships) in or near the Traffic Separation Scheme (TSS).
2. Production platforms near the TSS.
3. Production platforms or drilling rigs in the separation zone.
4. Platforms/rigs near the TSS dogleg.
5. Platforms/rigs near the safety fairway/TSS intersection(s).
6. Platforms/rigs at northern end of TSS.
7. Vessel navigation accuracy while transiting the Channel.
8. Supply boat, crew boat, barge traffic in all areas.

These situations were synthesized into a number of scenarios, which were then subjected to analysis and simulation.

### 3.6 CAORF Simulation

A total of thirteen (13) conditions was developed to examine the responses of the mariner (through his navigation of the vessel) to a variety of platform and drill ship siting configurations, and with regard to potential traffic encounters in the Santa Barbara Channel. The scenarios occurred in a part of the Santa Barbara Channel approximately 15 miles in length, between the mainland and the channel islands, and centered about Port Hueneme, California.

The data base was divided into two segments, one starting 4.5 miles south of the Port Hueneme Access Fairway, extending to the turn axis of the TSS on a course of  $300^{\circ}$ T along the northbound traffic lane (Segment A). The second segment (Segment B) started at the turn axis and extended along the  $285^{\circ}$ T leg of the northbound traffic lane to a point 5 miles beyond the turn axis (Figure 1).

A total of four conditions were presented in Segment A and nine in Segment B. One condition in each segment (A1 and B1) served as a baseline run to assess individual trackkeeping performance in the absence of the interactive traffic vessels or obstructions near the northbound traffic lane.

Mariner responses to various small vessel traffic in and about the traffic lanes and interactive ship traffic at the lane's intersection with the access fairway at Port Hueneme were the subject of Segment A runs under three conditions (Figure 2). In addition to the traffic, two scenarios included the presence of fixed platform in the separation Zone near the fairway intersection, the position of which was known by the subject and plotted on the chart. Segment A scenarios were run in daylight with a three mile visibility range.

The nine conditions in Segment B were all run in daylight with restricted visibility (0.5 mile). The visibility conditions imposed are not uncommon for the area. Eight of the nine conditions in the B Segment investigated the response of ship masters to different configurations for stationary drill vessels alone and in conjunction with fixed platforms, near to or straddling the traffic lanes (Figure 3). A worst case condition was investigated where visibility was poor and subjects had no foreknowledge of drilling vessel and platform positions. Because of the imposed visibility condition, the vessel's radar was heavily relied upon. In order to prevent subjects from taking a complacent attitude after a few runs to the stationary targets representing platforms and drilling rigs, a number of additional vessels were included in each scenario so that no immediately discernable pattern would be displayed on the radar PPI. A variety of chaff vessels including other ship traffic, fishing boats, and support craft such as crew boats, supply boats, tugs and barges, etc., performed different maneuvers so that plotting of all echoes became necessary in order to distinguish slowly maneuvering vessels from stationary targets.

Wind, current and visibility conditions were comparable to actual local conditions during late Summer/early Fall. Wind was input as westerly at 15 knots and the current was about 0.5 knot setting  $090^{\circ}$ T. The reduced visibility conditions differed by scenario segment and were described previously.

The two vessel types simulated for ownship were an 80,000 DWT tanker and a 12,000 GRT containership, to be operated by 10 tanker and 10 containership masters in each category respectively.

The CAORF bridge contained the same equipment regardless of the ship type simulated. A full array of control and monitoring equipment as well as navigation aids was made available to the test subjects. In particular, two functioning radars were available for navigation and collision avoidance problem solving. These equipments were strongly relied upon in the reduced visibility conditions which were imposed.

All conditions which were presented required the master to be conning the vessel due to the reduced visibility and the presence of traffic, particularly the increased density of vessel traffic in the approaches to Port Hueneme. The master in each case was assisted on the bridge by the Watch Officer, a qualified and licensed second or third mate. A helmsman was provided and steering was in the manual mode. While the Watch Officer performed duties assigned by the master, he was instructed not to volunteer any information unless it pertained to the assigned duty (such as the master requiring him to call out range and bearing to all radar contacts). The master was required to make all decisions based on the information available and without consultation with the Watch Officer.

The same conditions were presented to both groups of masters in a random order. To compensate for differences in speed between the tanker and the container vessel, (15.5 knots for the tanker and 19.3 knots for the containership) start positions and timing of the programmed interactive traffic vessels (no more than two vessels in any condition) were adjusted.

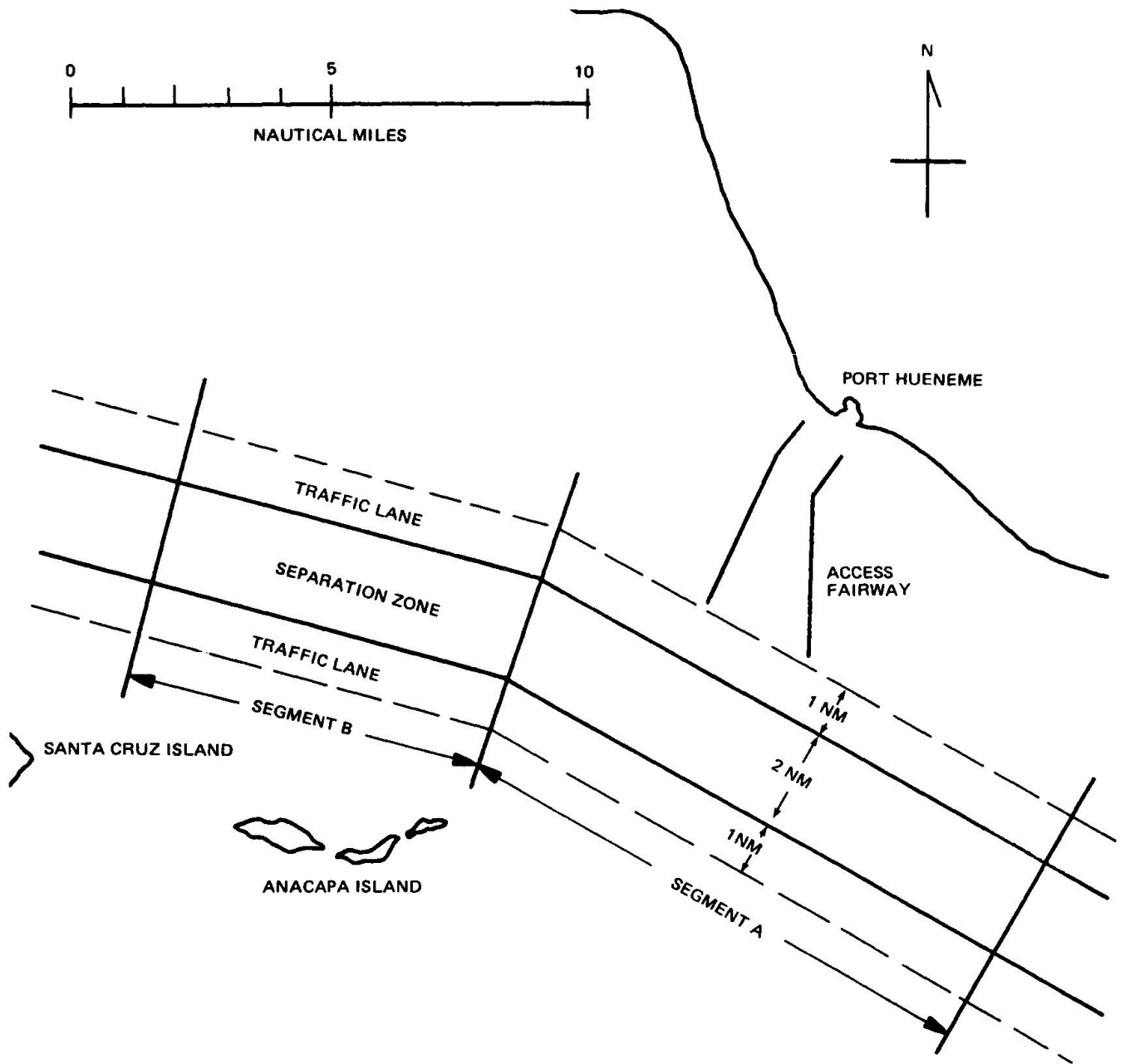

Figure 1. The Santa Barbara Channel Traffic Separation Scheme Showing Segments A and B Used to Develop Various Simulation Scenarios

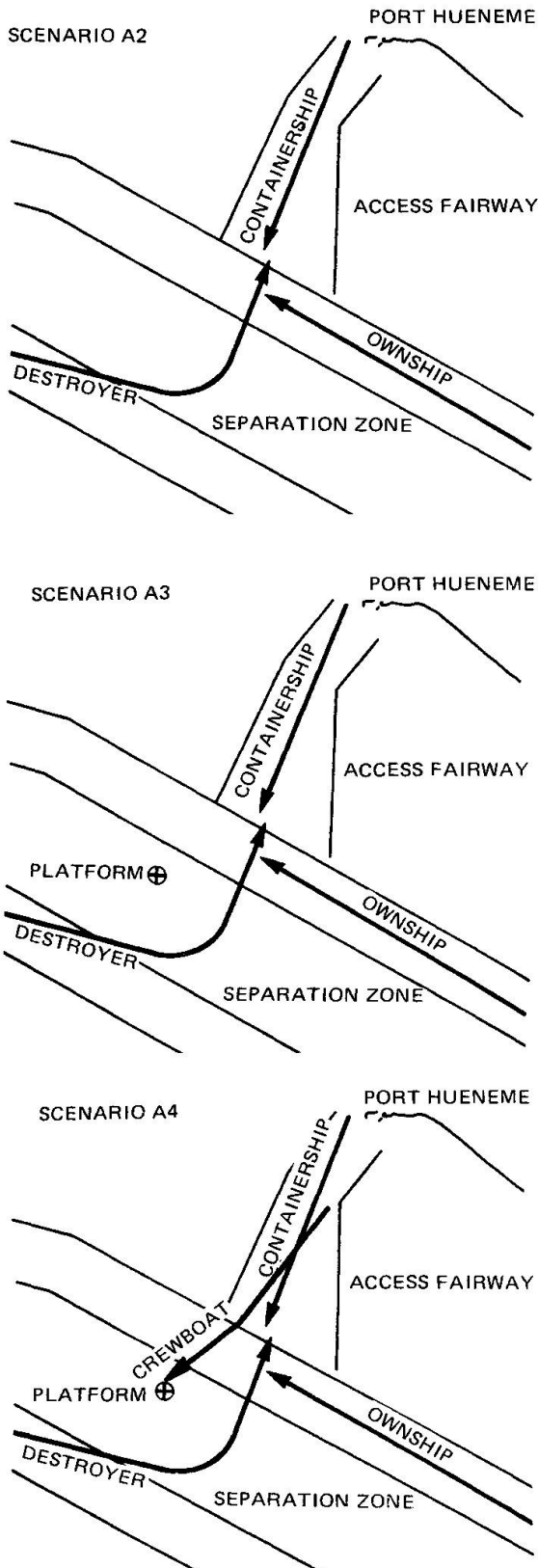

Figure 2. Segment A Scenarios Showing Three/Platform Configurations About the Traffic Lanes and Access Fairway. Chaff Traffic Not Detected.

### 3.7 Results and Recommendations

The man-in-the-loop simulation conducted involved two generic problems to be encountered in the Santa Barbara Channel. They were:

- The effects on merchant ship traffic of stationary drill rigs and platforms near the edge of the traffic lane.
- The effects on merchant ship traffic of other crossing traffic in the vicinity of a safety fairway intersecting the traffic lane.

#### Stationary Drill Ships/Rigs Near the Traffic Lane

The experiments conducted with a single stationary drill ship near the edge of the traffic lane indicated that ship masters definitely reacted to the presence of the drill ship (Tables 1 and 2). The evasive maneuvers of test subjects ranged from small maneuvers to maneuvers out of the traffic lane on the side opposite the stationary drill ship. In general, maneuvers were smaller with the drill ship set back 500 meters from the edge of the traffic lane than with the drill ship located at the edge of the traffic lane.

Additional experiments were conducted with the drill ship and a platform located opposite one another at the edges of the traffic lane, forming a "gate." Faced with the prospect of either leaving the traffic lane to go around the gate, or navigating through the gate, most masters remained in the lane and sailed through the gate. Navigation performance as well as post-experimental debriefings indicate, however, that many did so with reluctance.

Subsequent experimental runs were made in which the opposing rig of the above gated configuration was moved down the lane a distance of 1 and 2 nautical miles to form staggered gates. The responses of the test subjects were more variable in these situations than in either of the single drill ship or gated configurations, especially on the part of the tanker masters. Several test subjects left the lane completely to avoid the situation and there was a significant difference between the containership and tanker master performance. Containership masters tended to sail down the center of the lane with little or no deviation. Tanker masters were more likely to perform a slalom type of maneuver, moving right away from the drill ship and then to the left away from the subsequent rig. This slalom maneuver was more pronounced in the tanker master group with the 2 mile staggered configuration.



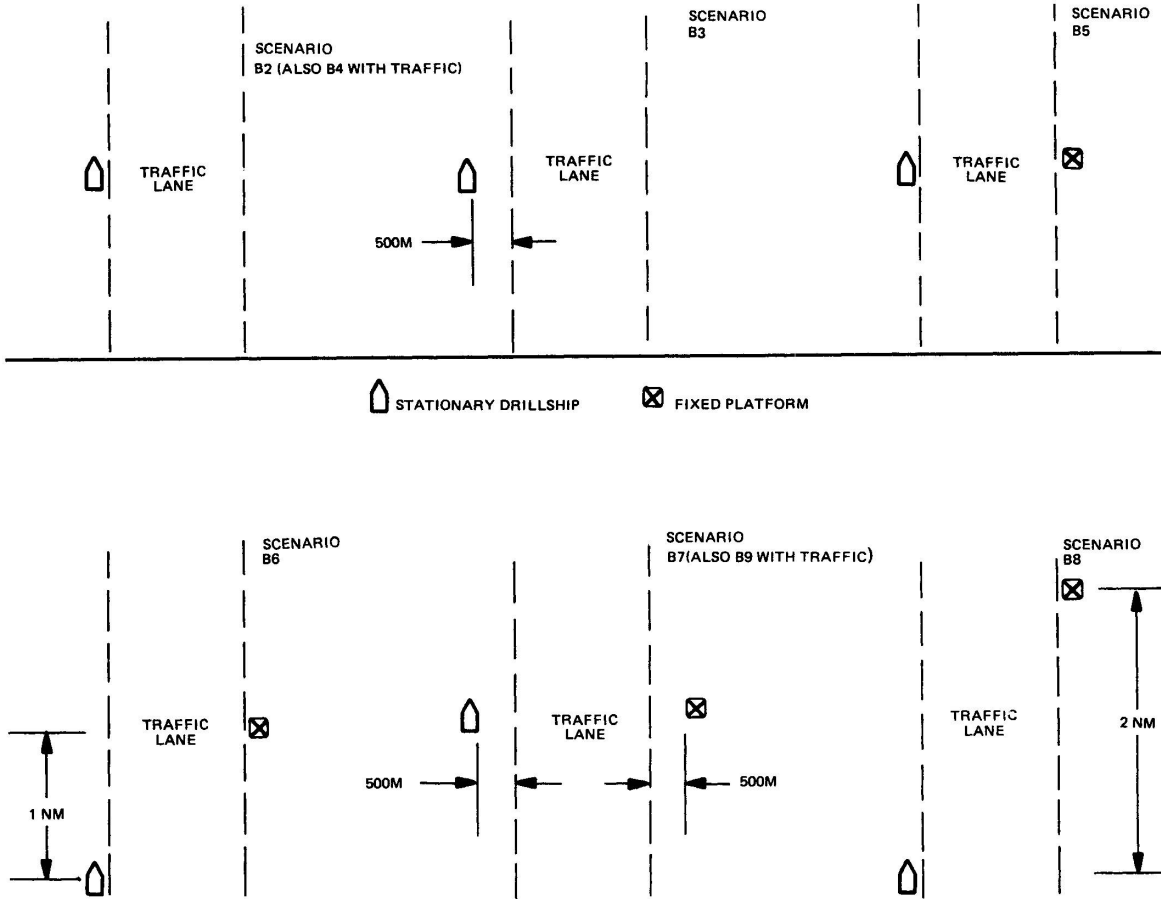

Figure 3. Segment B Scenarios Showing Various Drill Ship/Platform Configurations About the Traffic Lane (Dashed Lines)

**TABLE 1. TEST SUBJECT MANEUVERING RESPONSES IN SCENARIOS B1, B2, B3, AND B4**

Group	B1				B2				B3				B4			
	R	RS	R/RS	MCS	R	RS	R/RS	MCS	R	RS	R/RS	MCS	R	RS	R/RS	MCS
Tanker	0	1	0	9	5	0	3	2	3	2	1	4	6	0	3	1
Containership	0	0	1	9	8	0	0	2	3	1	0	6	7	0	3	0
Total	0	1	1	18	13	0	3	4	6	3	1	10	13	0	6	1

R = Right turn.

RS = Speed reduction.

R/RS = Right turn in conjunction with speed reduction.

MCS = Maintain course and speed.

#### AVERAGE MAXIMUM DEVIATION FOR SCENARIOS B2, B3, AND B4

	Tanker Masters				Containership Masters				All Masters			
	B1	B2	B3	B4	B1	B2	B3	B4	B1	B2	B3	B4
Average Maximum Deviation (n.m.)	0.04	0.25	0.16	0.30	0.04	0.34	0.14	0.36	0.04	0.30	0.15	0.33
Standard Deviation (n.m.)	0.04	0.18	0.21	0.25	0.05	0.33	0.15	0.13	0.04	0.26	0.18	0.20

#### Cross Traffic Encounters at Fairway Intersections

This part of the simulation experiment presented the test subjects with vessel traffic of a crossing nature, encountered while ownship was navigated within the lanes of a Traffic Separation Scheme (TSS). The problem simulated for the mariners took place at an intersection of a Port Access Fairway with the traffic lanes at Port Hueneme, California.

Conditions which co-existed with the traffic encounter problem included the presence or absence of a fixed structure within the TSS (a production platform), and varying levels of small craft such as resource recovery support vessels.









The results of these simulation runs showed a variety of responses to the crossing traffic problem which are independent of the restriction/workload conditions. More tanker masters than containership masters departed the traffic lanes in executing their avoidance maneuvers and reduction of speed was a prominent characteristic of the former group (Figure 4). Although these out-of-lane deviations were made with little hesitation in order to comply with the collision regulations, the higher frequency of occurrence within the tanker group is consistent with the maneuvering characteristics inherent in large tankers versus the capabilities of the fine-lined, high speed containership. The tendency among the tanker masters to reduce speed initially indicates a more conservative reaction to the traffic problem.

The siting of a stationary object in the Separation Zone, either alone or in conjunction with additional small vessel traffic, did not appear to influence the maneuvering decisions. These conditions were apparently assigned a priority which was secondary to the maneuvering requirements with respect to the capital ships present. Likewise the subjects' individual criteria for acceptable passing distances to other vessels, and their perceived obligations under the International Regulations for Preventing Collisions at Sea (COLREGS '72) in a crossing situation, took precedence over the exhibited desire to remain within the confines of the traffic lanes.



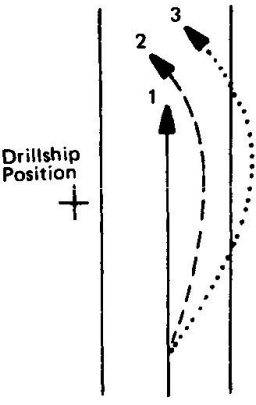

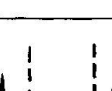
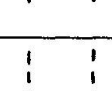
**TABLE 2. COMPARISON OF THE PERFORMANCE CHARACTERISTICS EXHIBITED BY SUBJECTS IN RESPONSE TO EACH OF THE CONFIGURATIONS PRESENTED IN SEGMENT B SCENARIOS**

Drill Ship/Platform Configurations	Scenario	Subject Group	Performance Characteristic (No. of Subjects)			Subjects per Group	SUBJECT GROUP CODE  T = Tanker  C = Containership
							
	B2	T	2	7	1	10	 <p>Comparison of the performance characteristics exhibited by subjects in response to each of the configurations presented in Segment B Scenarios.</p>
		C	2	6	2	10	
	B3	T	6	3	1	10	
		C	7	3	—	10	
	B5	T	5	1	—	6	
		C	6	—	—	6	
	B7	T	5	—	1	6	
		C	6	—	—	6	
	B6	T	2	2	2	6	
		C	6	—	—	6	
	B8	T	1	4	1	6	
		C	5	—	1	6	

### Recommendations

1) No structures, whether of a permanent or temporary nature, should be permitted to be situated in the traffic lane of a TSS nor within a Safety Fairway. This should include stationary drill ships and drilling rigs engaged in exploratory operations. In particular, the idea of moving the traffic lanes on a temporary basis to accommodate such drilling activities is not recommended. The logistics involved in effectively communicating such a lane change to the worldwide marine community are substantial, and it is unlikely that complete dissemination of information could occur in any short period of time. The negative implications for safety are obvious.

2) Permanent structures should not be sited within 500 meters of the boundary of a Traffic Separation Scheme lane in order to maintain the integrity of the established lane-width. The erection of two structures on opposite sides of a traffic lane so as to form a "gated" configuration should not be permitted if either structure would be sited within 1000 meters of the closest lane boundary. If a permanent structure is positioned within 1000 meters of the nearest lane boundary (but not closer than 500 meters in any case) no structure should be permitted to be erected on the opposite side of the traffic lane within 1000 meters of the opposite boundary for a distance of at least two nautical miles in either direction along the lane from the initial structure.

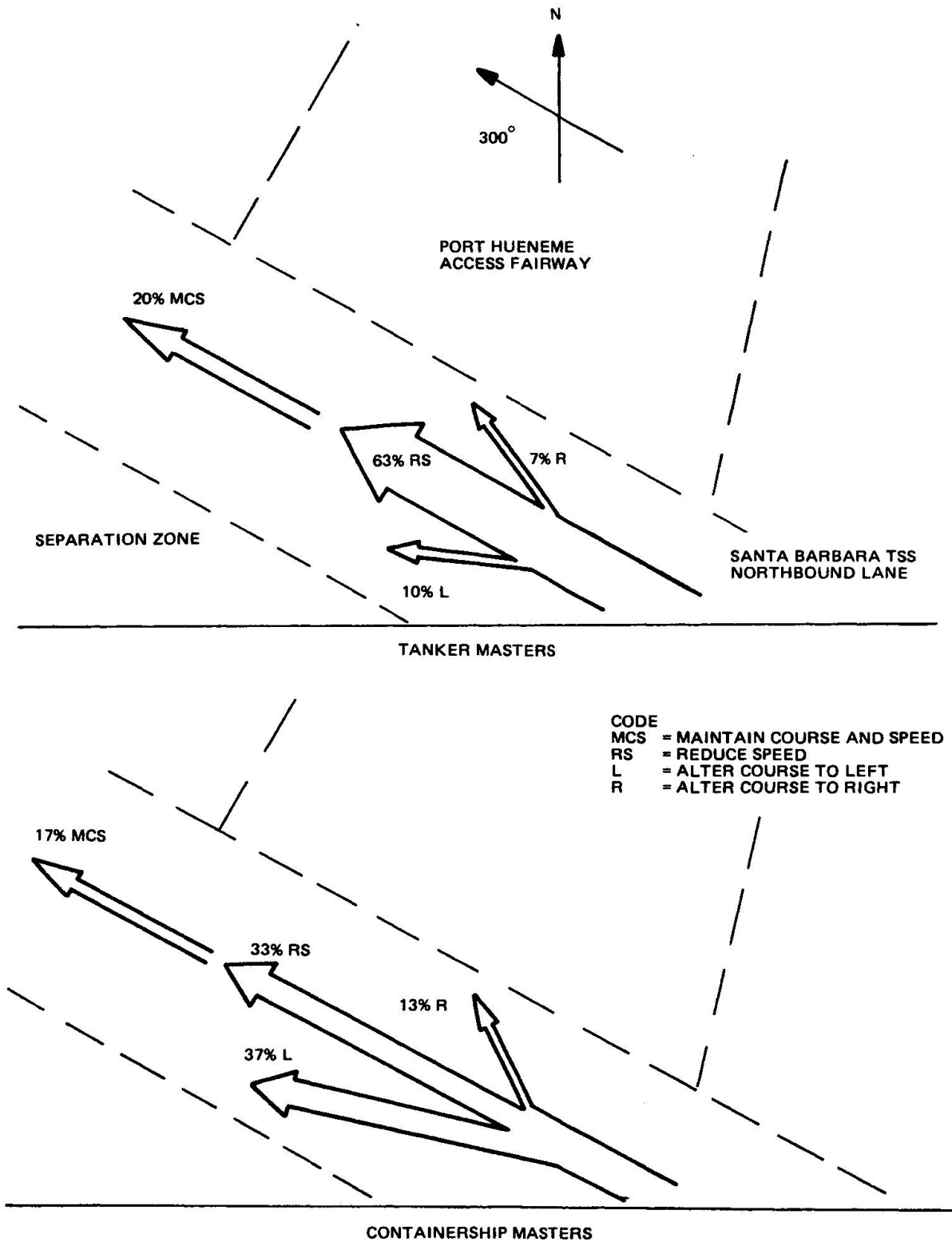

Figure 4. Graphic Presentation of the Distribution of Initial Commands in Response to the Collision Avoidance Problem in Scenarios A2 - A4



- 3) The presence of even temporary structures (e.g., drill ships, drilling rigs, or other resource recovery-related obstacles) within 500 meters of the traffic lane poses some threat. While the mitigation measures can be devised to reduce this threat, there is not adequate information at this time to conclude that it would be reduced to an acceptable level.
- 4) No temporary or permanent obstructions, including platforms, drilling rigs, and drill ships should be permitted to be erected or to operate within the extension of an intersecting Safety Fairway through the TSS traffic lanes or Separation Zone, nor within 1000 meters of the traffic lane boundaries and extension boundaries at the intersection.
- 5) A marshalling or designated waiting area should be defined during the construction of pipelines or erection of any structure where tug/barge units or other support craft involved in the operation will impact the users of the traffic lanes. Such marshalling areas should be situated well clear of the Traffic Separation Scheme, Safety Fairways, and normal approach routes utilized by tankers enroute to coastal terminals, and will serve to consolidate slow moving small craft away from the shipping routes. It will also minimize the number of points at which the traffic lanes would be crossed by these craft enroute to the construction site.

## REFERENCES

1. Maritime Risk Management Procedures, National Maritime Research Center, 1979.
2. FARAGER, W.E. et al., Deepwater Ports Approach/Exit Hazard and Risk Assessment, United States Coast Guard Report No. CG-D-6-79, 1979.
3. Santa Barbara Channel Risk Management Program, National Maritime Research Center, Report No. CAORF 24-8015-01, 1981.

## Safety of Bridges and Offshore Structures - the Role of Ship Simulation

Sécurité des ponts et des constructions offshore - rôle de la simulation navale

Sicherheit bei Brücken und Offshore-Bauten - die Bedeutung der Schiffsimulation

**John S. GARDENIER**  
Operations Research Analyst  
U. S. Coast Guard  
Washington, DC, USA



John S. Gardenier, born in 1937. Bachelor of Arts, Yale University. Master of Science and Doctor of Business Administration, The George Washington University. Eleven years in ship safety research.

### SUMMARY

Bridge safety is not solely structural safety. There is an inherent variability in the operation of ships. This variability precludes absolute assurance that a bridge or other structure will not be damaged by a ship if such damage is physically possible. Some of the variability is inherent in human performance; other parts of it relate to environmental conditions and the availability and adequacy of information. In any event, it is only the human beings directing ship movements who can preclude out-of-tolerance variance. For this reason, all efforts at ship operational safety, including those of bridge and structural engineers, should be oriented to the point of view of the human pilot or master who will direct the ship. Simulation and simulators can help in that process.

### RÉSUMÉ

La sécurité des ponts n'est pas seulement une question de sécurité structurelle. Le mouvement des navires représente un risque inévitable. Ce risque exclue la garantie absolue qu'un pont ou autre structure ne sera pas endommagé par un navire si un tel dommage est physiquement possible. Une partie de ce risque est due au facteur humain, d'autres parties sont causées par l'environnement et par les sources d'information. En tous cas, seuls les êtres humains qui dirigent les mouvements du navire peuvent exclure un risque intolérable. Dans ce but, tous les efforts y compris ceux des ingénieurs de ponts et de structures, pour tendre à la sécurité des mouvements de navire, doivent être orientés vers le point de vue du pilote humain ou le capitaine du navire. La simulation peut contribuer à cet effort.

### ZUSAMMENFASSUNG

Brückensicherheit ist nicht nur eine Frage der Sicherheit des Bauwerks. Der Schiffahrt wohnt eine ständige Veränderlichkeit inne. Dieses Risiko bildet keine absolute Gewähr dafür aus, dass eine Brücke oder ein anderes Bauwerk von einem Schiff nicht beschädigt wird, wenn eine solche Beschädigung physisch möglich ist. Ein Teil des Risikos ist auf menschliche Faktoren zurückzuführen, andere Teile rühren von umweltmässigen Faktoren sowie von der informationsquellen her. Unter allen Umständen sind nur die Leute, die Schiffe steuern, instande, ein nicht annehmbares Risiko auszuschliessen. Alle Bestrebungen zur Erhöhung der Schiffahrtssicherheit einschliesslich der der Brückenbauingenieure, müssen deshalb auf die Ansicht des menschlichen Pilots oder des Schiffführers, der das Schiff steuern wird, ausgerichtet werden. Simulation kann bei diesem Prozess behilflich sein.



## 1. INTRODUCTION

Throughout the world, there are hundreds of thousands of bridges to carry rail, highway, or foot traffic over navigable waterways. In many cases, the bridges seem to be armored massive bastions compared to the frail shells of craft which glide beneath them. One would not expect a straying gondola to damage the Bridge of Sighs in Venice.

Increasingly, however, ships tend themselves to be ponderous behemoths of masses and momentums against which virtually no bridge can stand. If we assume that these huge ships will continue to "attack" bridges, adding sufficient armored mass to the bridge structure itself seems an impossible defense. It would be better to provide a neutral "buffer zone". This means restricting bridge supports and low spans to locations where the surrounding waters are so shallow that any stray ship of sufficient mass to damage the bridge would be summarily halted hard aground before it could reach the structure.

In cases where this is infeasible, it is necessary for bridges to negotiate with ships. Bridges could defend themselves better by provoking ships less. Especially provocative is the practice of locating bridges near sharp bends in the navigation channels. Placing two or more bridges close to each other, with narrow openings, with openings misaligned relative to patterns of current flow, and requiring a lift span rather than providing for a high fixed span are all somewhat provocative. To combine several of these provocations in a single location is to invite "attack".

Bridges may also invite a "jostling" by haughtily ignoring ships rather than speaking politely to them. It is "courteous" for a bridge to "speak" using day markers and lights or radar reflectors to mark the channel location.

Bridges can strengthen their diplomatic status further by allying themselves with allies of the ship, especially channels/basins of adequate width and depth and good aids to navigation. If a ship gets out of control upstream due in part to overly confined waters and poor information, both the ship and bridge may be helpless as the natural flows bring them together.

Even the most courteous and diplomatic bridge cannot effectively limit the degree of variability in the passage of ships beneath it. Only the human beings controlling the ships can do that. It may well be that the best way for us to avoid bruising steel and concrete realities is through creative and imaginative use of structured unrealities.

## 2. SHIP ACCIDENTS WITH BRIDGES

### 2.1 Some Specific Accidents With Bridges

#### 2.1.1 AFRICAN NEPTUNE - Sidney Lanier Bridge[1]

Shortly after leaving the State Docks in Brunswick, Georgia, on the evening of 7 November 1972, the AFRICAN NEPTUNE struck the Sidney Lanier Bridge 350 feet south of the channel centerline. Three sections of the bridge and ten vehicles fell into the river, killing ten persons and injuring eleven. The bridge was closed for about six months. Repair costs were approximately US\$1.3 million. The National Transportation Safety Board determined that the probable cause was (1) the failure of the third mate to apply the correct rudder in response to two helm orders; (2) the failure of the third mate, master and pilot to discover the first error and (3) their delay in detecting and correcting the second error.[1]



### 2.1.2 MARINE FLORIDIAN - Benjamin Harrison Memorial Bridge

On 24 February 1977, the SS MARINE FLORIDIAN experienced a steering system failure about 500 meters from the Benjamin Harrison highway bridge. The resulting collision collapsed the northern tower span. On 6 March 1977, the span, including the northern main tower of the bridge collapsed onto the vessel and into the river. Total damage to the bridge and the vessel was estimated to be US\$8.5 million. The National Transportation Safety Board determined that the probable cause was inadequate maintenance and inspection of a manual transfer switch in the electrical circuit, which opened by gravity and interrupted power to the steering motor. Contributing causes were the operation of the vessel at a speed higher than necessary for a safe passage, failure of the steering alarm to function, and not having any person on watch in the steering engine room, which precluded prompt activation of the alternate steering engine.[2]

### 2.1.3 Motor Vessel STUD - Southern Pacific Railroad Bridge over the Atchafalaya River near Berwick Bay, Louisiana.

On 1 April 1978, a four-barge tow with the Motor Vessel STUD collided with the eastern fixed span of the Berwick Bay railroad bridge and knocked the span from its supporting piers into the river. Damage to the STUD, a push towboat, was estimated at US\$4,000. Bridge damage was US\$1.4 million, including the cost of replacing the bridge span and rerouting rail traffic for eight days. The National Transportation Safety Board determined that the probable cause of the accident was the failure of the master to align his tow properly. Contributing factors were inadequate criteria for commencing high water limitations in the Berwick Bay Vessel Traffic Service area, inadequate horsepower of the STUD relative to the length of its tow and the maneuvering conditions, and the master's lack of timely information concerning the river stage and velocity.[3]

### 2.1.4 SUMMIT VENTURE - Sunshine Skyway Bridge, Tampa Bay, Florida

On 9 May 1980, the SUMMIT VENTURE struck and destroyed a support pier of the Sunshine Skyway Bridge over Tampa Bay, Florida. About 395 meters of bridge deck and superstructure fell into the bay from a height of about 46 meters. Thirty-five people died as several vehicles plunged into the bay. Repair costs were estimated at about US\$30 million for the bridge and US\$1 million for the SUMMIT VENTURE. The National Transportation Safety Board determined that the probable causes of this accident were a line of intense thunderstorms which overtook the vessel as it approached the bridge and the pilot's failure to abandon the transit despite losing his visual and radar references for the channel and bridge in the heavy rain. Contributing to the loss of life was the lack of a structural pier protection system which could have absorbed some of the impact force or redirected the vessel. Also contributing to the loss of life was the lack of a motorist warning system.[4]

## 2.2 Generic Causes of Bridge Collisions

### 2.2.1 Bridge Collision Studies

In the mid-1970's, a study was conducted of bridge collisions in the United States.[5] The larger number of these accidents involve push towboats and barges on our river and inland waterway system. Generally, these vessels make more bridge passages per day of operation than do large ships. As a result, there are more reported bridge accidents involving these vessels from which to establish causal patterns. These patterns can be applied to situations involving larger ships by assessing the relevance of specific factors to particular vessels, bridges and local traffic.





The primary cause of towboat accidents with bridges is loss of control on the approach to the bridge. In seventy-three percent of the towboat cases studied, the loss of control was due to a current-induced rotation and delayed operator correction. The forces that cause rotation increase linearly as the angle of rotation increases. In many scenarios a critical angle of rotation can be reached where recovery is impossible. One of the reasons delaying operator correction is the difficulty of perceiving the onset of rotation, especially at night. Most current caused accidents occur at night and to loaded vessels, some of which seem to be underpowered. Most wind caused accidents occur in daylight, to vessels in ballast, and are due to unique conditions at specific bridges. The major ways to reduce these accidents are to improve the navigability of the bridge approaches, to improve the quality and timeliness of information to the vessel operator (see section 5.3.2), and to assure adequate power availability for loaded vessels. In the case of some ship passages, assisting tugboats may be necessary.

### 2.2.2 Human and Physical Factors in Vessel Accidents

Regarding the human factors involved, we conducted studies from 1976 through 1979 to identify shiphandling tasks and any deficiencies in task performance contributing to accidents.[6,7,8] Most vessel accidents occur to highly competent and experienced personnel who are in good physical and mental condition. There are, of course, exceptions where accidents are caused by personnel who are excessively fatigued, ill, incompetent or affected by drugs, alcohol, medication, or emotional stress. Similarly, the majority of vessels involved in the accidents experienced no failure of their control mechanisms, although steering and propulsion failures do cause a minority of the accidents. Only about twenty percent of these accidents are due to tangible equipment or operator failings.

The dominant characteristics of vessel collisions with bridges are geometric and environmental. Geometric factors are primarily the placement of bridges near bends in the navigation channel, the relative sizes of the vessels and the bridge spans, and the adequacy of line-of-sight information (visual and radar). Environmental factors of note are following currents, cross currents, current speed, cross winds, wind speed, and factors reducing visibility or radar performance. Operational factors include traffic or other obstacles near or in the bridge approach channel, reserve power available with or without tugs, and the timing of drawbridge operations.

We lack good data on the relative frequency of ship passages through drawbridges as contrasted with fixed span bridges. Thus, the relative risks are not known. It was observed, however, that over half of harbor bridge rammings were at drawbridges. The involvement of a moving span does introduce added risk factors over fixed spans. Apart from possible problems of timing the bridge opening and possible failure of the bridge mechanism, there are serious risks of communication problems between bridge and vessel personnel.

### 2.2.3 Possibilities for Improving Bridge Navigability

Critical shiphandling requirements in general are summarized in Figure 1. from a variety of studies. These were selected in the process of identifying skills that might be usefully improved through ship simulator training. Many of these same factors, however, can also be addressed by local port authorities or by other authorities at their request. Examples are placement and design of rail or highway bridges (avoiding drawbridges and locations near river bends), improving aids to navigation to make them more useful and reliable, widening or deepening channels, and establishing special local rules or procedures regarding traffic, speed and use of tugboats.



		ORI [8,9]	TAEG [11]	NTSB [12]	SHIPPING COMPANY ANALYSIS [13]	T & L WORKING GROUP	DET NORSE VERITAS [14]	MTRB [15]
RESTRICTED WATERS NAVIGATION MANAGEMENT	VESSEL TO VESSEL COMMS	●	◐	●	○	○	○	◐
	SHIPHANDLING					●	◐	
	- SAFE SPEED	◐		●				
	- MAINTAINING POSITION	●						
	- COMPENSATING FOR EXTERNAL FORCES		◐					
	PILOT/MASTER RELATIONSHIP	◐	◐	●	●	●		●
	BRIDGE PROCEDURES			●	●	○	◐	●
	- LATE DETECTION	●						
	- FAILURE TO MONITOR OTHER VESSEL	◐						
	- FAILURE TO ESTABLISH NAVIGATION POSITION	◐						
	- FAILURE TO TAKE ADEQUATE FIXES		◐					
	BRIDGE ORGANIZATION			◐	●			○
	- VESSEL MANNING						●	
	RULES-OF-THE-ROAD		○	●		●	◐	○
	EMERGENCY SHIPHANDLING					●		
	NAVIGATION				◐		◐	○
	- FAILURE TO ESTABLISH NAVIGATION POSITION	◐						
	- FAILURE TO TAKE ADEQUATE FIXES	◐						

● DENOTES HIGH CRITICALITY STRESSED  
 ◐ DENOTES MEDIUM CRITICALITY NOTED  
 ○ DENOTES IMPLIED CRITICALITY INTERPRETED

Figure 1. Summary of Critical Shiphandling Skills





The U. S. Coast Guard, among other functions, has a Bridge Administration Program "to ensure safe and reasonably unobstructive navigation through or under bridges spanning the navigable waters of the United States, while meeting the needs of other transportation modes and protecting the human environment." [9] This program includes bridge lighting for navigation, regulation of drawbridge operations, approval of new or replacement bridge locations and plans, and removal or alteration of existing bridges at public expense if it is determined that a bridge obstructs navigation in an unreasonable way as a result of changes in the needs of navigation. [10]

### 3. OFFSHORE STRUCTURE RISKS

#### 3.1 TEXACO NORTH DAKOTA Collision with Artificial Island EI-361-A

##### 3.1.1 Accident Report Summary

About 0430 on 21 August 1980 the TEXACO NORTH DAKOTA collided with a partially constructed artificial island for oil production. See Figure 2. The forward cargo tanks were ruptured resulting in a fire that destroyed the forward part of the cargo tank area and the midships house. The fire burned for several days before it was extinguished by a professional firefighting team. The salvaged vessel was later declared a constructive total loss. The damage to the artificial island was at least US\$11 million and possibly more than US\$12.6 million. The owner decided not to repair the structure. The National Transportation Safety Board determined that the probable cause of the accident was the failure of the system which provided information about the location of hazards to navigation do so in this case, the failure of the ship's master to acquaint himself with the latest marine information before navigating near offshore structures on the outer continental shelf. A contributing factor was the failure of the marine construction company to maintain the aids to navigation on the offshore structure. [16]

##### 3.1.2 Aids to Navigation

Navigation lights were installed on the partially constructed oil rig on 24 July 1980. The lights had not operated after Hurricane Allen passed through the area 8-11 August 1980. The platform builder requested an inspection and servicing of these lights on 13 August. On or after 22 August, the service contractor replied that the inspection had not been made due to the large numbers of service requests received.

##### 3.1.3 Advisory Information

Information regarding the aids on the platform was published in a Local Notice to Mariners on 1 August 1980 but not in a Weekly Notice until 30 August. The vessel sailed on 4 August 1980, not having either notice. It was not clear whether local notices were ever used by the ship, although weekly notices were used regularly. From 8-22 August 1980, the U. S. Coast Guard Eighth District broadcast a generic warning about storm damage to warning lights on rigs. It was not clear to the safety board whether such broadcast warnings were recorded or heeded aboard the ship.

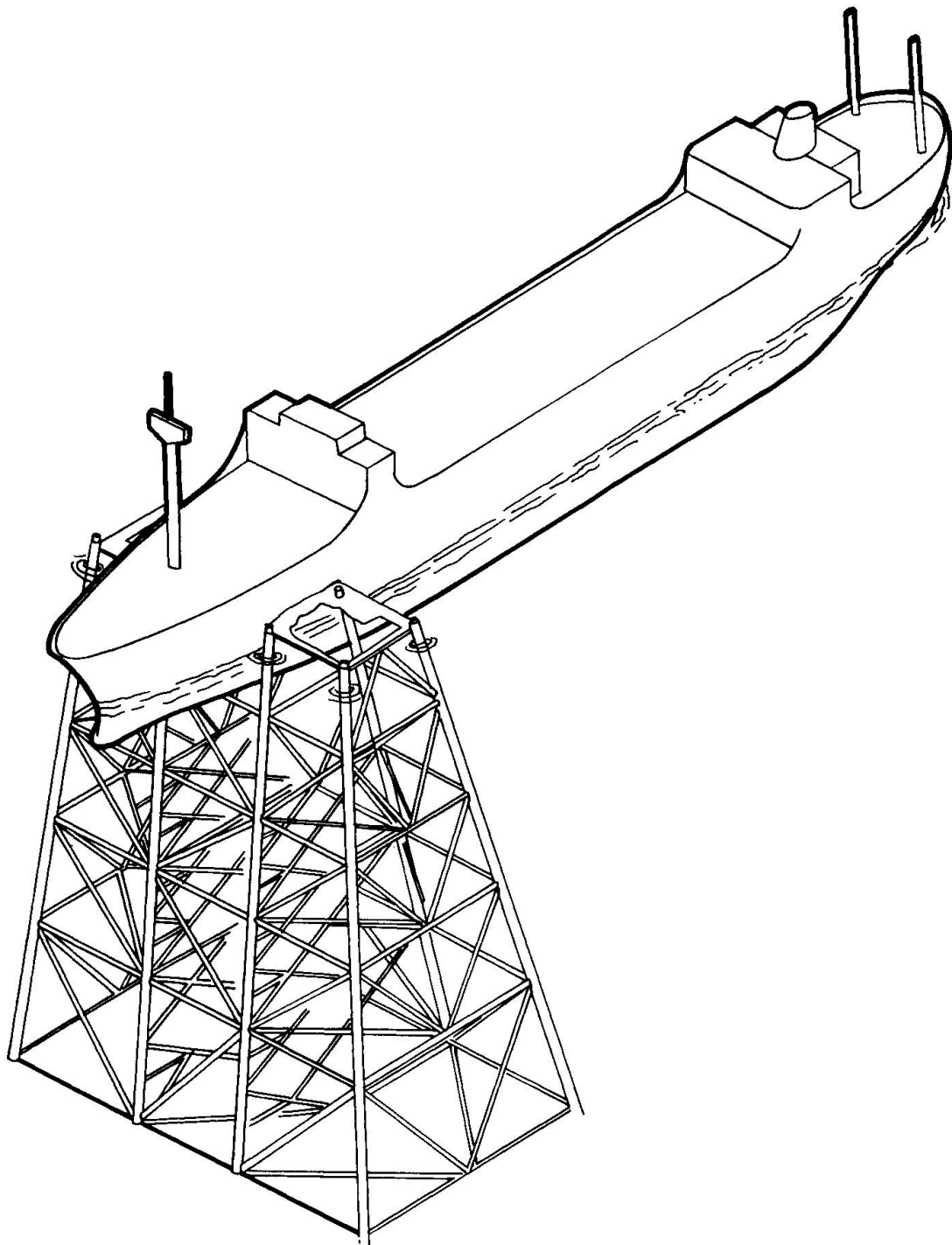

Figure 2.-Sketch showing TEXACO NORTH DAKOTA impaled on well jacket.



### 3.1.4 Waterway Information

To provide vessels with reasonably safe shipping lanes along the Gulf Coast, a system of Shipping Safety Fairways were established. The fairways are unmarked and are approximately two miles wide. Oil well or other fixed structures are not permitted within these fairways although several have been erected on the edges of fairways. Mariners are advised by the Coast Pilot to take advantage of the safe passageways made available by these fairways, but their use is not mandatory. Many vessels continue to use courses outside the fairways, opting to "run the rigs" based on their local knowledge. Testimony before the safety board revealed that the fairways are mostly used by foreign vessels.

### 3.1.5 Information Bearing on Rig Detectability

The ship lookout capability consisted of two radars and seamen's visual lookout. Of these, one radar was turned off. The operative radar had a three degree blind sector slightly left of due ahead. The watch officer was aware of the blind sector. Although it seems likely that the island was in the ship radar's blind sector just preceding the collision, it is also true that the tubular steel structure of the artificial island presents only one fourth the echo strength of a plane or a corner radar reflector. Visually, it was a clear, dark morning. The lookout was placed on the port bridge wing although he might have been stationed at the bow of the 172 meter ship. He warned the watch officer of the island too late to avoid the collision.

## 3.2 General Considerations in the Risk of Ship Collisions with Offshore Structures

### 3.2.1 Risk Analysis Approaches

The term risk analysis often refers to a probability distribution of adverse deviations from some safe or desired norm. In the case of ship operations, the safe norm is usually taken to be a nominal representative trackline. Models may then be postulated which assume an inverse relationship between the magnitude of track deviation and the probability of the deviation being that large. Alternatively, data on historical accidents are modeled in relation to data or projections regarding some "exposure" variable such as ship trips, volume of cargo carried, or simply time. Given estimates of risk, decision-makers are supposed to decide whether the risks are "acceptable." While such calculations have some intuitive appeal, inherent fallacies of such approaches led this author to present an argument against this whole risk assessment/acceptance approach at the 1982 Annual Meeting of the American Association for the Advancement of Science.[17] A written version, entitled "The Technological Risk Acceptance Myth," is in preparation. For the matter at hand, the following considerations are sufficient:

-There is seldom a single representative trackline for vessels in any waterway. In fact, the intended track may vary substantially with wind, current, water depth, ship size, ship type, visibility, and a number of other factors including arbitrary choices by the ship master or pilot.

-Given that an environmental, human or mechanical cause for deviation from some intended track occurs, is there any empirical, physical or logical principle which constrains its magnitude to be more often small than large (within the physical limits, of course)? The best hope would be that constant vigilance results in prompt detection of any deviation and that excellent passage planning has provided a ready correction for any contingency. While these goals should certainly be pursued, available evidence indicates that such goals have not been reached in shipping or in most other fields of endeavor.[18]

### 3.2.2 Hazard Analysis Approaches

In a study of the risks and hazards of navigational approaches to the then-planned (now operational) Louisiana Offshore Oil Port (LOOP) in the Gulf of Mexico, relatively little of the effort was devoted to risk analysis. The major reason was that the computation of risk normally provides little or no information on how best to manage that risk. A credible statistical estimate that the risk (of oil spills in this case) is significant constitutes sufficient reason to refocus analysis on the most suitable and feasible ways to manage that risk. That, in turn, usually involves a qualitative analysis of the specific nature of the hazards.

To understand offshore navigational dangers, several analytic approaches were taken. First, general trade routes of the vessels were laid out. Recorded hazards were compiled from published references: charts, Sailing Directions and Coast Pilots. Analysts rode vessels in appropriate coastal passages and visited a similar monobuoy port. Discussions with ships officers, pilots and port authorities were productive. All available accident data for the area of interest were compiled and analyzed. A series of "fault trees" (logical hazard diagrams) were constructed. Finally, all sources of data were combined into a hazard classification scheme.[19] The many hazards could be grouped into two major areas: human factors and severe weather, plus two less major hazards: fixed structures and floating debris. A variety of issues concerning offshore fixed structures and human factors in ship operations were subsequently investigated in a real time ship simulator study discussed in section 5.2.3 of this paper.

## 4. TOWARD A HUMAN-ORIENTED CONCEPT OF SHIP SAFETY

### 4.1 The Engineering Disciplinary Approach

There have been numerous observations that, while accident data stress human factors, safety research has tended to focus on engineering solutions in specific disciplines: structural, nuclear, naval architecture, electronics and others. In the ship safety area, this process has been noted quite pointedly by the National Academy of Sciences, as well as by the current author and other individuals.[20,21] Partly as a result of this process, the hardware system tends to become somewhat more reliable than the human system. A great many accidents are then seen as being due to "human error", largely because no "mechanical failure" is observed. This is certainly the case in ship operations.

### 4.2 The Systems Safety Approach

The more modern approach has been to expand the focus to a "systems safety" approach. In this concept a variety of engineering disciplines are integrated into (hardware) "systems engineering," which is then combined with consideration of operational factors, such as material (or fluid or energy or information) flows, queues, and bottlenecks.[22]

"Human engineering" may or may not be integrated into the system. "Human engineering" considerations, if any, usually include design and layout of dials, displays and controls; anthropometric (body measurement) considerations of body position, reach and required strength; and task analytic issues regarding the layout of work spaces, allocation of tasks to people, skill requirements and training needs. More recently, issues of work-rest cycles, environmental stress (noise, vibration, temperature) and teamwork have been included.



#### 4.3 A Statistical Quality Control Approach

None of these approaches have really addressed the human situation in a manner that would satisfy statistician W. Edwards Deming, one of the fathers of modern industrial quality control and one of the men given special credit for the economic revitalization of Japan after World War II. Dr. Deming has observed that only about fifteen percent of industrial accidents or system failures or product deficiencies are attributable to tangible specific failures of either people or machines. In those cases where the tangible failures occur, it is clear that equipment was poorly designed or maintained or that an individual was unsuited to the job or had received clearly inadequate training or supervision.[23]

Of far greater significance, however, most failures occur because of random variance which is inherent to the functional system itself and should not be blamed on any individual. Nonetheless, there is usually some individual who was "on watch" or who "made the mistake" and therefore can be found to be "at fault." It does seem a little strange to some of us, however, that in many cases such people are not found to be the incompetents but rather operators whose work records and attitudes have been highly regarded by their peers and their supervisors. That does not surprise Dr. Deming at all. In fact, it appears to confirm his concept of the nature of quality and alternatively of failure in the workplace.

In Dr. Deming's concept, variability is inherent in human performance, in the performance of specific pieces of equipment, in the environment and in all engineered systems. Accidents, system failures, and product defects can be eliminated only by narrowing the variability to acceptable tolerances throughout the system and by making the system tolerant of those that remain. It can never be assumed that we understand a complex system function well enough to prescribe or to deduce the tolerance of variability or the means of reducing it. The variability bounds must be determined empirically using certain types of statistical methods.[24,25] Establishing means of reducing the inherent system variability is a highly creative and eclectic process.

The possibility of achieving the accident free (or failure free) system rests on the prior condition of having a managerial framework which utilizes its human (and hardware) resources well. That managerial framework must include clear long range goals, credible commitment to quality of product or service, a receptivity to ideas and inputs from many different sources including its own workers, a working atmosphere which is free of fear, and several other factors. These are difficult, but achievable within the setting of a single industrial corporation.

#### 4.4 A Human-Oriented Approach to Maritime Safety

Maritime safety does not occur within the purview of a single organization. Furthermore, it does not seem either necessary nor feasible to create some monolithic institution to have effective control of all the equipment and people who affect maritime safety even in a specific location. How, then, can society gain effective control of maritime safety so as, for example, to preclude ship collisions with bridges and offshore structures?

The generic question was recently addressed by a committee of maritime executives, labor representatives, researchers, policy analysts, and risk/decision analysts under the auspices of the U. S. National Academy of Sciences.[26] It concluded, in effect, that the only people who can directly prevent ship accidents are: first, ship masters (and mates and pilots) and, second, shoreside ship operations executives and staff. The only way in which anyone else can do any good is by influencing these groups with regard to either their motivation for safety or else their capability to achieve safety!





The point may be understood either in a trivial sense (everybody knows these groups control ship movements) or else in a much more subtle and profound sense. To suggest more clearly the profound sense, it can be stated (although probably not without controversy) that the structural engineer has two functions regarding prevention of ship collisions with bridges and other structures:

-To so design the structures that they are in no danger from ships, and, to the extent this is infeasible -

-To so design the structure and its environs that ship operators are optimally motivated toward, and capable of, passing it safely every time.

The second point includes recognizing, for example, that shipping economics frequently demands large vessels, two way traffic, and minimal delays. Bridges or other structures which accommodate these inherent motivations outside the constraints of prior and independent physical aspects of the local waterway, are necessarily safer (all other factors being equal) than similar structures which do not. Where vessel traffic is hindered beyond some norm, ship operating managers are motivated to encourage some compensating measure on the part of masters or pilots. Even independently of shoreside management, the ingrained professionalism of the skilled mariner includes a certain amount of boldness in the expeditious accomplishment of his duties. This leads to some taking of calculated risks, and those risks, when the other variabilities happen to be unfavorable, lead to accidents.

Even if the second guideline (above) to structural engineers is accepted in the intended spirit, of course, there are many other groups that influence ship safety both favorably and unfavorably: international, national, and local governmental authorities; those who maintain waterways and off-ship navigational installations and services; ship builders and repairers, ship classification societies, and insurers; ship equipment designers and servicers; maritime trade unions and schools; and professional groups or societies in ship design, ship operations, ship ergonomics, ship economics, port design and management, and marine traffic engineering.

## 5. SIMULATION AND SIMULATORS

### 5.1 The Real and The Unreal

#### 5.1.1 Physical Reality

At the beginning of this paper, it was suggested that the best means of protecting steel and concrete realities might be the use of structured unrealities. The paradox is intended with all seriousness. A key thesis throughout this paper has been that several kinds of realities are crucial to the prevention of structural damage by ships. Only one kind of reality concerns the physics of structures, ship movements and momentums, impacts, plasticities and elasticities. This may be called the physical reality.

#### 5.1.2 The Reality of Uncertainty

At least as important analytically is the reality of random variability, of uncertainty in ship passages near structures. The major failing of risk analysis has been to treat this variability at too high a level of summarization and to prescribe quite unrealistic properties to the oversimplified models. What is needed is much less deductive prescription and much more inductive description so that we can learn more about the real nature of the uncertainty in ship operations. In short, we need to admit that we are even uncertain about the types and bounds of the uncertainty of ship operations.





### 5.1.3 Human Reality

An important part of the variability of ship operations is human variability. There are very basic scientific elements of human variability which relate to the design and function of the central nervous system, the psychology of learning and or memory, and to individual and social behavioral patterns conditioned by evolution, by current society and by individually influential persons and events. This, too, is reality. Of more direct interest is human performance and variability within the specific context of ship operations in restricted waters. Here the human must function as an imperfect controller of an inherently variable system, using variable control processes with time lags and measurement errors, in an environment of informational uncertainty. Both the training and the motivation of the personnel are influenced by a large number of factors, some of which rest in the organization and management of their companies, unions, or pilot associations. Other factors rest in specifics of operational scenarios. For example, does the design of a bridge and the approach to it suggest any concern or appreciation for the demands placed on the people who are somehow expected to get the ship safely by under all conditions of wind, current, visibility, equipment failure, and errors by other people? Such thoughts on the human condition also reflect reality.

### 5.1.4 The Desirable Unreality of Simulation

Simulations are never fully realistic. Reality is too complex to be modeled. More importantly, we create models in order to escape the full complexity of reality. In a similar vein, we do laboratory experiments by carefully eliminating many variables and attempting to control carefully all but one of those in the experiment (the dependent variable). When we do empirical research, we do not gather data on the full complexity of our subject, but only on specific items of interest which seem amenable to analysis. In fact, that is the essence of analysis - seeking out limited aspects of a problem and examining their interrelationships more precisely than we can do in the real world.

Simulations do represent selected aspects of reality; good simulations do this very well. They can help us to explore various components of ship operations variability under controlled conditions and in safety. Thus, although we see mercifully few instances of real major ship collisions with bridges each year, we can study many thousands of simulated passages and/or collisions per year by simulation.

## 5.2. Ship Simulation Studies

### 5.2.1. General

There have been hundreds of ship simulation studies conducted.[27] Some of them address dangers of capsizing [27], maritime traffic [28,29], economically efficient fleet deployment [30], port design [31] and inland waterway design [32]. Some have been fast time models, their logical control totally embedded within the computer and its programming. Some have been real time models, interfacing with human beings who make some of the control decisions and moves during each simulation "run". Some have modeled ship movements as they would occur under natural forces given the initial control settings; some have incorporated track-following autopilots; others have been optimal control models, capable of determining the "best" track feasible to maximize some specified performance criteria [33]. Some have been used for research; others for training or management. Many of these models could in some sense be used to improve bridge and offshore structural safety. This paper addresses mainly research by the U. S. Coast Guard Office of Research and Development. Hopefully, you will have independent access to a very large amount of excellent simulation elsewhere in the U. S., Europe, and Japan, as well as in a growing number of other maritime regions.



### 5.2.2. Towboat Simulations

Although various ship motion models have existed for a number of years, their sophistication and capability have been growing especially rapidly in the last few years. Not so many years ago, the computer models correctly described only the motions of a very few ship types for which extensive model testing had been accomplished and then only for movements in deep water (six or more times the vessel's draft) and only for forward movement. Because most ship accidents occur in shallow and restricted waters, this was a largely unsatisfactory capability.

With respect to bridge-vessel collisions, this was especially unsatisfactory due to the larger number of pushtow-bridge collisions than of ship-bridge collisions in the United States. Yet pushtows operate often at quite low speeds, at wide drift angles, in water that is very shallow relative to their depth and often with engines backing while the vessel is moving forward. Such conditions demanded a different approach to modeling than had been common in the case of larger ships.

The first real capability was described in a research report of May 1978.[34] It was immediately followed by an application study on bridge collision incidents. This was a pure physical process model, which directed the towboat as dictated by natural forces and the control settings. It occasionally displayed its current control settings to the simulation operator and asked if different settings were desired before it continued the passage.[35]

The problem with this early simulation was that it left all the real work of simulator experimentation to the operator while allowing him relatively little control or assistance. Within a year, analog-digital converters, controls and displays had been added to create a real time simulator with which an operator could interact more effectively to explore the physical consequences of alternative control strategies.[36]

In order to support fast time simulation research more effectively, numerous hydrodynamicists have developed autopilots (track-following controller programs). The simulation described above has been utilized both as a fast-time, autopilot-controlled simulation and as a real time, human-controlled simulator to investigate the serious problems of passing the Berwick Bay bridges.[37] Additional research is being conducted on the Berwick Bay bridge problem. Refinements of that same simulation capability are now being developed to analyze low water shiphandling problems on the upper Mississippi River.

### 5.2.3 Tanker and Other Vessel Simulations

It was also found that the slow speed, backing and shallow water capabilities of this model were useful in the analysis of large tanker maneuvers within offshore deep water ports.[38] The combination of fast time and real time simulation capabilities of this and other simulation facilities can support a large variety of bridge and other structural design studies.

The simulations discussed above are mainly oriented to the controllability of the vessel. In some cases, masters or pilots help assess vessel controllability under various conditions, but these people are not themselves the focus of the studies.



### 5.3 Simulators and Shiphandling Behavior

#### 5.3.1 Distinguishing Characteristics

As contrasted with vessel controllability studies, shiphandling behavioral simulations have two distinguishing characteristics:

-the simulators always have people in the simulator control loop

-the simulators require a sizeable and fairly accurate perspective view to provide suitable cues to the human controller because that individual's perceptual skills are involved in the overall operation just as much as shiphandling knowledge and professional judgment.

These features tend to be important to research studies because the precise methods used by mariners in the conduct of their passages has not been completely, or even largely, documented. It is, therefore, impossible to include all of the appropriate assessments and decision criteria in the logic of any automatic controller.

Key types of behavioral simulator studies have addressed appropriate designs and equipment for ships bridges, the training of vessel crews and pilots, and crucial features of ports in terms of their ease of navigation in a human, "user-friendly" sense (over and above the basic vessel controllability in a given waterway.)[39,40]

#### 5.3.2 Research Into the Selection and Placement of Aids to Navigation

One of the widely applicable lines of research being pursued in the United States is development of guidelines for off-ship aids to navigation. These include buoys, lights, daymarks, ranges, radar beacons and other means to help the mariner to evaluate vessel position, orientation and velocity in the waterway. For centuries, various such devices have been placed by unaided professional judgment. Until recently, it has not been possible to bolster those judgments with scientifically determined guidelines and rationales.

Recent and ongoing simulator studies are now determining the behavioral effects of alternative types, numbers and placements of aids. It has definitely been determined that some placements can narrow the range of track deviations within a given waterway.[41] Presumably, the pragmatically more effective patterns of aids to navigation provide more complete, timely or reliable information to the mariner than do alternative patterns. Reports on the progress of this research will be issued steadily.

#### 5.3.3 Mariner Training Studies

Another general area in which behavioral simulator studies are making progress is in mariner training. Very distinct and practical gains have been assessed in the training of ship crew teams[42], ship engineers[42,43], and ship pilots[44,45].

This author, with Dr. Thomas J. Hammell and others, has been particularly involved in research into what aspects of simulators, simulator instructors and training technology are most effective in improving mariner performance[46,47]. Two reports are now nearly complete which establish guidelines for the design and conduct of mariner simulator training for both senior mariners and cadets (mariner students). Additional studies in this series are also planned.



### 5.3.4 Simulators and Navigation Near Offshore Structures

With respect to possible collisions of ships with offshore structures, we have studied navigational approaches to an offshore oil port[48, 49]. One of the noteworthy findings in that research is shown in Figure 3. This is a display of the tracklines selected by current, professional large tanker masters, given a common starting point and simple instructions to proceed safely to the offshore port. The black squares on the chart represent oil rig locations. The parallel lines mark "safety fairways" as described in section 3.1.4 of this paper. Noting the wide variations in navigational strategy employed by these masters and the wide track variance apparent in the majority strategy reinforces the emphasis on uncertainty of ship operations. Any "risk analysis" of this problem which might have laid out a single, representative track and then computed theoretical deviations from that track would have been wide of the mark indeed!

All of the transits depicted were made safely, although one master did comment in retrospect that he had come a little too close to the rigs. All participants agreed that the simulated vessel in this study handled like its real world counterpart. All stated that they had been able to adapt to the simulator so that their responses to the conditions presented were the same as they could be at sea. As a result of this research, recommendations were made regarding port procedures, nautical chart design, and shipboard equipment.

## 6. CONCLUSIONS

-Vessel operational safety is crucial to preventing ship collisions with bridges and offshore structures.

-Although risk analyses are desirable, it is likely that existing methods underestimate the varieties and magnitudes of uncertainty in ship operations.

-As between physical, systems safety, and human-oriented concepts of vessel operational safety, there are strong reasons to favor the latter. (All of these approaches are nonetheless relevant to safety.)

-Given that vessel operational safety is relevant, a variety of fast time and real time simulation methods can aid in needed assessments of vessel controllability.

-Perspective view vessel simulators can be applied to research and training in a variety of ways which can aid in the human-oriented approach to vessel operational safety.

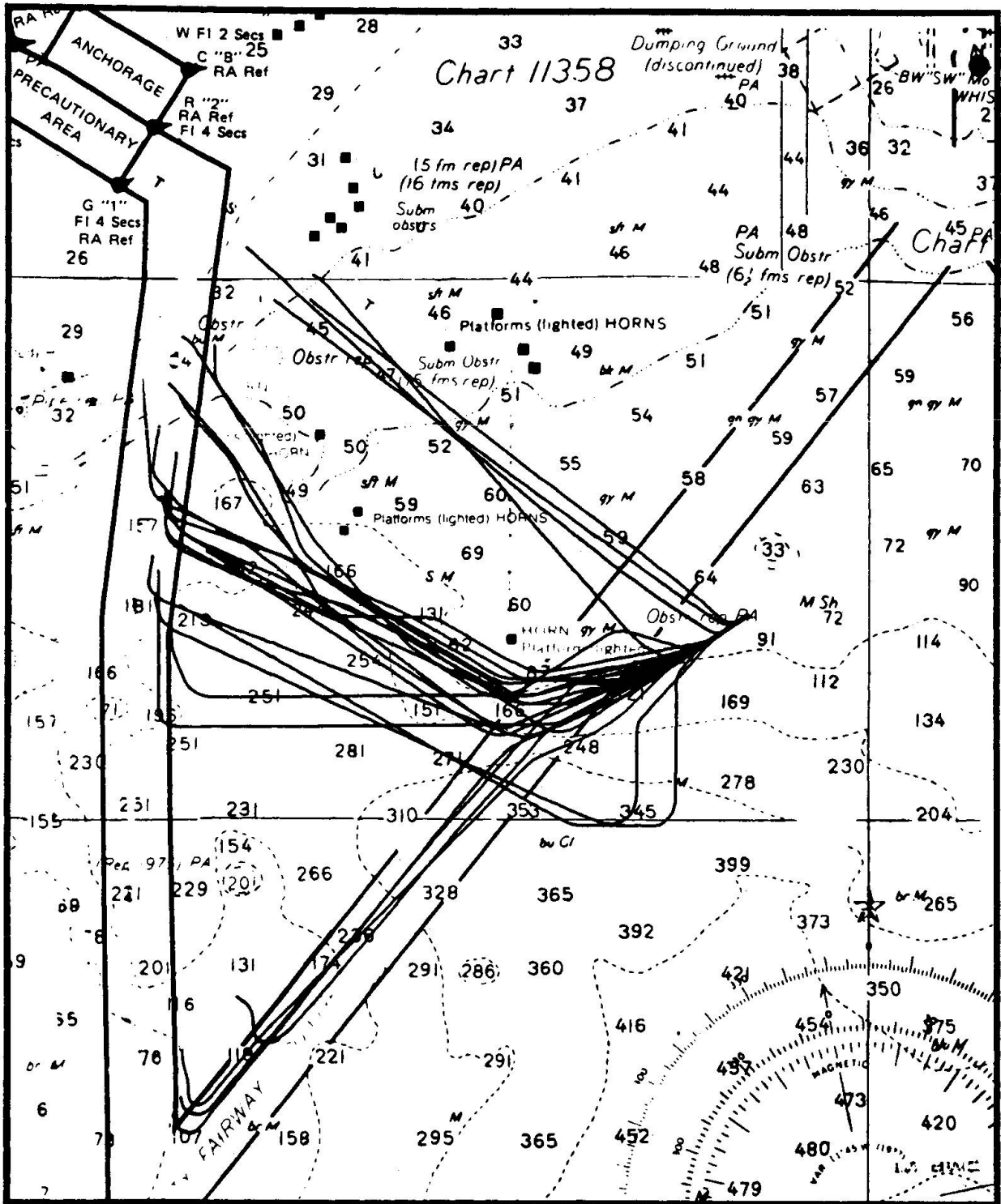

FIGURE 3. INDIVIDUAL SHIP TRACKS DURING THE COASTWISE APPROACH



## REFERENCES

1. U. S. Coast Guard Marine Casualty Report, SS AFRICAN NEPTUNE, Brunswick, Georgia, 7 November 1972, USCG/NTSB-MAR-74-4.
2. National Transportation Safety Board (USA), NTSB, Marine Accident Report: U. S. Tankship SS MARINE FLORIDIAN Collision with Benjamin Harrison Memorial Bridge, Hopewell, Virginia, 24 February 1977, NTSB-MAR-78-1.
3. NTSB, Collision of the M/V STUD with the Southern Pacific Railroad Bridge over the Atchafalaya River, Berwick Bay, Louisiana, 1 April 1978, NTSB-MAR-80-5.
4. NTSB, Ramming of the Sunshine Skyway Bridge by the Liberian Bulk Carrier SUMMIT VENTURE, Tampa Bay, Florida, 9 May 1980, NTSB-MAR-81-3.
5. DAYTON, R. B., Analysis of Bridge Collision Incidents, Volume (V) I, National Technical Information Service Number (NTIS) AD-A029 034 and V. II, December, 1976, NTIS AD A036 732.
6. SMITH, J. and others, Task Analysis Report Relative to Vessel Collisions, Rammings and Groundings, December 1976, V. I - NTIS AD A037 316, V. II - NTIS AD A037 317, V. III - NTIS AD A037 442.
7. PARAMORE, B. and others, Human and Physical Factors Affecting Collisions, Rammings and Groundings on Western Rivers and Gulf Intracoastal Waterways, January 1979, NTIS AD A074 290.
8. PARAMORE, B. and others, Study of Task Performance Problems in Reports of Collisions, Rammings and Groundings in Harbors and Entrances, March 1979, NTIS AD A071 058.
9. U. S. Coast Guard, Bridge Administration Operating Program Plan: Fiscal Years 1983-92, p. 1.
10. U. S. Congress, Committee on Commerce, Science and Transportation, The U. S. Coast Guard, 1 March 1982.
11. CORDELL, C. C. and NUTTER, R. V., Shiphandling and Shiphandling Training; Training Analysis and Evaluation Group (TAEG) Naval Training Equipment Center, December, 1976.
12. NTSB, Annual Reports to Congress, 1977, 1978, 1979, and 1980.
13. BUTT, J. A., Recent Developments in Navigation Training, in Safe Navigation Symposium Proceedings, Oil Companies International Marine Forum, Washington, D. C., January 1978.
14. Karlsen, J. E. and S. Kristiansen, Cause Relationships of Collisions and Groundings: Statistical Survey of Collisions and Groundings for Norwegian Ships for the Period 1970-78, Det Norske Veritas Research Division, Oslo, March, 1980.
15. Maritime Transportation Research Board (MTRB), Human Error in Merchant Marine Safety, National Academy of Science (US), January 1978.
16. NTSB, U. S. Tankship SS TEXACO NORTH DAKOTA and Artificial Island EI-361-A Collision and Fire, Gulf of Mexico, 21 August 1980, NTSB-MAR-81-4.





17. GARDENIER, J. S., "Beyond Statistics to Risk Management", Presentation at the American Association for the Advancement of Science Annual Meeting, Washington, D. C., 3-8 January 1982.
18. RASMUSSEN, J. and ROUSE, W. B. (editors), Human Detection and Diagnosis of System Failures, Plenum Press, London and New York, 1981.
19. FARAGHER, W. E. and others, Deepwater Port Approach/Exit Hazard and Risk Assessment, February 1979, NTIS AD A074 529.
20. MTRB, Research Needs to Reduce Maritime Collisions, Rammings and Groundings, National Academy of Science, 1977.
21. GARDENIER, J. S., Toward a Science of Marine Safety, in C. C. GLANSDORP (ed.), Marine Traffic Systems, Maritiem Institut, The Netherlands, 1976. Portions reprinted in Schiff und Hafen, July 1976.
22. HAMMER, W., Handbook of System and Product Safety, Prentice-Hall, Englewood Cliffs, New Jersey, 1972.
23. DEMING, W. E., Management of Statistical Techniques for Quality and Productivity, 1981.
24. SHEWHART, W. A., The Economic Control of Quality of Manufactured Product, American Society for Quality Control, 1980.
25. ISHIKAWA, K., Guide to Quality Control, Asian Productivity Organization, Tokyo, 1976.
26. MTRB, Marine Safety: A New Orientation, 1982.
27. FALLON, W. J. and others, Model Tests and Numerical Simulation of Ship Capsizing in Following Seas, January, 1980, NTIS AD A100 306.
28. GRASSLER, E. and MEADER, N., Vessel Traffic Services Traffic Management Summary Report, 2 July 1981, NTIS AD A106 376.
29. NOE, P. P. and VELDHUYZEN, W., The Use of Simulation Techniques as a Tool for Vessel Traffic Management, TNO Institute for Mechanical Constructions, Delft, The Netherlands, March, 1981.
30. KAPLAN, M. and others, Scheduling Product Distribution by Tanker, in Proceedings of the 1981 Summer Computer Simulation Conference, July, 1981.
31. COOK, R. C., Evaluation of Deep Draft Coastal Port Designs, in Proceedings of the Fourth Annual CAORF Symposium, Kings Point, New York, 29-30 September 1980.
32. SCHUFFEL, H., Simulator Study on the Design of Inland Waterways, in Proceedings of the Fifth Ship Control Systems Symposium, Annapolis, Maryland, 30 October - 3 November 1978.
33. WEINER, L. B. and MOON, A., Vessel Navigation System Simulation, V. I-III, January, 1982.
34. MILLER, E. R., The Prediction of River Tow Maneuvering Performance, May 1978, NTIS AD A805 9408.



35. PETRIE, G. L., Simulation of Bridge Collision Incidents Involving Inland Waterway Tows, June 1978.
36. VAN DYKE, P. and MILLER, E. R., Towboat Maneuvering Simulator, V. I-III, May 1979.
37. VAN DYKE, P., An Analysis of the Berwick Bay Bridge Passage, June 1980, NTIS AD A093 092.
38. BARR, R. A. and others, Maneuvering of Tankers at Deep Water Ports, February, 1981.
39. Nautical Institute (UK), MARSIM 78: First International Conference on Marine Simulation, Southampton, UK, 5-8 September 1978.
40. CAORF, MARSIM 81: Second International Conference on Marine Simulation, Kings Point, New York, 1-5 June 1981.
41. SMITH, M., BERTSCHE, W. R. and SCHROEDER, K. R., The Use of Real Time Man-In-The-Loop Simulation to Measure the Effectiveness of Aids to Navigation Configurations, in Proceedings of OCEANS 80, Marine Technology Society, Washington, D. C., October 1980.
42. MILLAR, I. C. and REYNOLDS, J., Marine Simulator Developments in the United Kingdom, in MARSIM 81.
43. JASPERS, B. W., Training of Ship Engineers, MARSIM 81.
44. WILMS, O., The Training of Pilots on a Shiphandling Simulator, MARSIM 81.
45. HUSSEM, J. and DeBOER, C., Seven Years Experience With Simulator Training of VLCC Pilots in the Netherlands, MARSIM 81.
46. GARDENIER, J. S. and HAMMELL, T. J., Shiphandling Simulator Standards and Training Techniques, MARSIM 81.
47. HAMMELL, T. J., The Training Device is More Than a Simulator, MARSIM 81.
48. COOK, R. C., MARINO, K. L., and COOPER, R. B., A Simulator Study of Deepwater Port Shiphandling and Navigation Problems in Poor Visibility, January 1981, NTIS AD A100 656.
49. GARDENIER, J. S., Navigational Safety Approaching Offshore Deepwater Ports, in Proceedings of the 1981 Oil Spill Conference, Atlanta, Georgia, 2-5 March 1981.

Leere Seite  
Blank page  
Page vide