

**Zeitschrift:** IABSE reports = Rapports AIPC = IVBH Berichte

**Band:** 48 (1985)

**Artikel:** Seismic resistant system for a composite steel-concrete building

**Autor:** Mazzolani, Federico M.

**DOI:** <https://doi.org/10.5169/seals-37483>

### **Nutzungsbedingungen**

Die ETH-Bibliothek ist die Anbieterin der digitalisierten Zeitschriften. Sie besitzt keine Urheberrechte an den Zeitschriften und ist nicht verantwortlich für deren Inhalte. Die Rechte liegen in der Regel bei den Herausgebern beziehungsweise den externen Rechteinhabern. [Siehe Rechtliche Hinweise.](#)

### **Conditions d'utilisation**

L'ETH Library est le fournisseur des revues numérisées. Elle ne détient aucun droit d'auteur sur les revues et n'est pas responsable de leur contenu. En règle générale, les droits sont détenus par les éditeurs ou les détenteurs de droits externes. [Voir Informations légales.](#)

### **Terms of use**

The ETH Library is the provider of the digitised journals. It does not own any copyrights to the journals and is not responsible for their content. The rights usually lie with the publishers or the external rights holders. [See Legal notice.](#)

**Download PDF:** 30.03.2025

**ETH-Bibliothek Zürich, E-Periodica, <https://www.e-periodica.ch>**

## Seismic Resistant System for a Composite Steel-Concrete Building

Système antisismique pour un bâtiment mixte acier-béton

Erdbebensicheres System für ein Gebäude in Stahl-Beton Verbundbauweise

### Federico M. MAZZOLANI

Prof. of Struct. Engineering  
University of Naples  
Naples, Italy



Federico M. Mazzolani, born 1938 in Milan, received his civil engineering degree at the University of Naples in 1961. Author of about 130 scientific papers mainly in the field of stability, plasticity and metal construction. From 1970 to 1979 Chairman of the ECCS Committee «Aluminium Alloy Structures». At present Chairman of the ECCS Committee «Seismic Design».

### SUMMARY

This paper briefly describes the structural criteria which have been followed in designing the building for the new Fire Station in Naples. Starting from a previous architectural solution, the structure has been adapted to resist design seismic forces recently introduced in this area. The structure is a composite steel-concrete system in which four floors are hung from a top grid. Special devices have been introduced in order to guarantee a proper seismic risk protection due to the relevant importance of this kind of building.

### RÉSUMÉ

Cet article présente brièvement les critères structuraux qui ont été utilisés pour la construction du nouveau bâtiment des pompiers à Naples. Partant du projet architectural, la structure a été adaptée pour résister aux normes sismiques récemment mises en vigueur dans cette région. La structure mixte acier-béton est constituée de quatre planchers suspendus à un treillis supérieur. Des dispositifs spéciaux ont été introduits pour assurer une sécurité suffisante contre les séismes, compte tenu de l'importance de ce type de bâtiment.

### ZUSAMMENFASSUNG

Der Vortrag beschreibt kurz die baulichen Kriterien, welche bei der Planung des neuen Feuerwehrgebäudes in Neapel befolgt werden mussten. Ausgehend von einer früheren architektonischen Lösung wurde ein Tragwerk gewählt, welches der seismischen Belastung, die erst vor kurzem in dieser Gegend eingeführt wurde, widersteht. Die Konstruktion besteht aus einem Stahl-Beton Verbund-System, bei dem vier Stockwerke an einem Dachfachwerk aufgehängt sind. Spezielle Vorrichtungen wurden eingeführt, um eine einwandfreie Erdbebensicherheit dieses wichtigen Gebäudes garantieren zu können.

## 1. INTRODUCTION

A fundamental aspect of an appropriate structural design is to armonize shape and strength of the building. This trend becomes a determinant requirement when the construction belongs to a seismic area and in particular its seismic resistance is of capital importance for civil protection.

Seismic resistant structures are usually designed by introducing in the load combination appropriate enhancement factors which affect the seismic action in order to adapt the degree of seismic protection to the social and economic significance of the relevant building category.

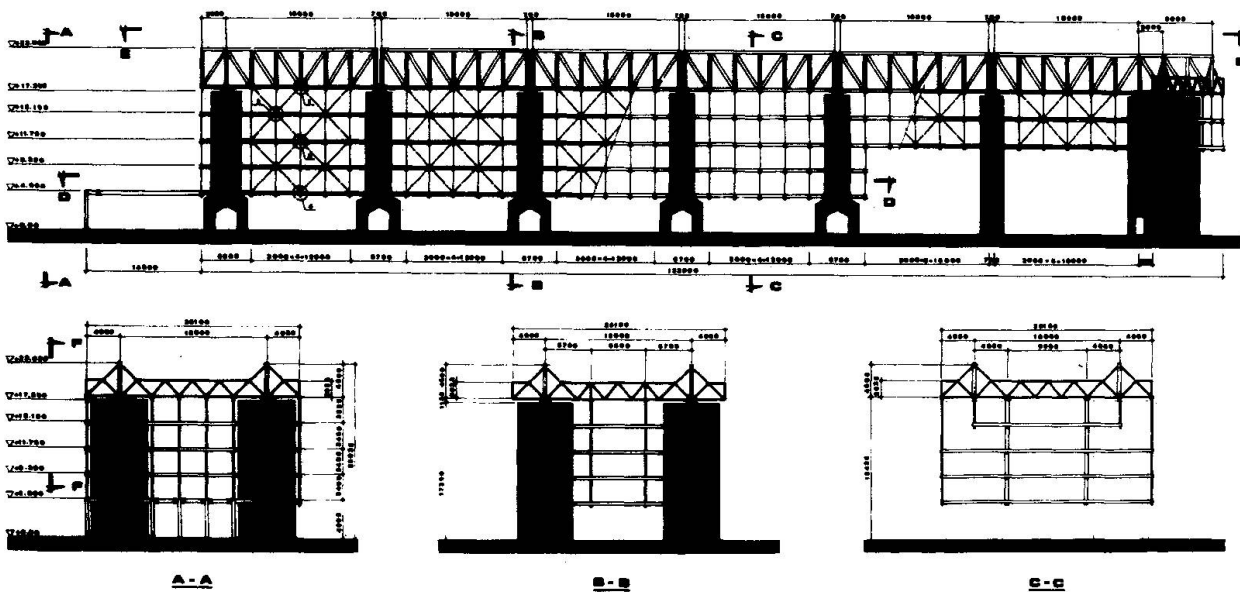

Fig. 1 - General view of the structure.

In the case of important buildings as hospitals, electricity plants, fire stations, etc. the degree of seismic protection is taken into account by means of structural factors. Incidentally in these cases of highest importance the Eurocode "Earthquake" recently suggested a value of 1.4.

Under the design earthquake actions given by codes, structures have to exhibit a given combination of strength, deformability and energy-absorbing capacity. Strength is necessary to withstand the design seismic actions while remaining elastic. Deformation means that structures must be able to safely deform beyond their elastic limit during severe earthquakes and survival is due to their capability to undergo inelastic deformations. Large deformations are a necessary prerequisite for significant energy absorption. The reliability of the solution is reached by providing a suitable combination of these main behavioural aspects.

The structural system used in the new fire station building in Naples (Italy) represents - in our opinion - a significant example which show how a building, which has been previously designed on the main basis of the architectural requirements without considering seismic actions, could be adapted to face the seismic actions with a given seismic risk protection.

## 2. DESIGN CRITERIA

The structural system adopted for the fire station building belongs to the category of steel-concrete composite structures, where the main vertical bearing elements are the reinforced concrete towers containing stairs and elevators (Fig. 1).

The steel structure, which represents a rigid skeleton, is completely supported by the concrete towers. The floor structures are hanged to a top grid made of longitudinal and transversal reticular girders (Fig. 2).

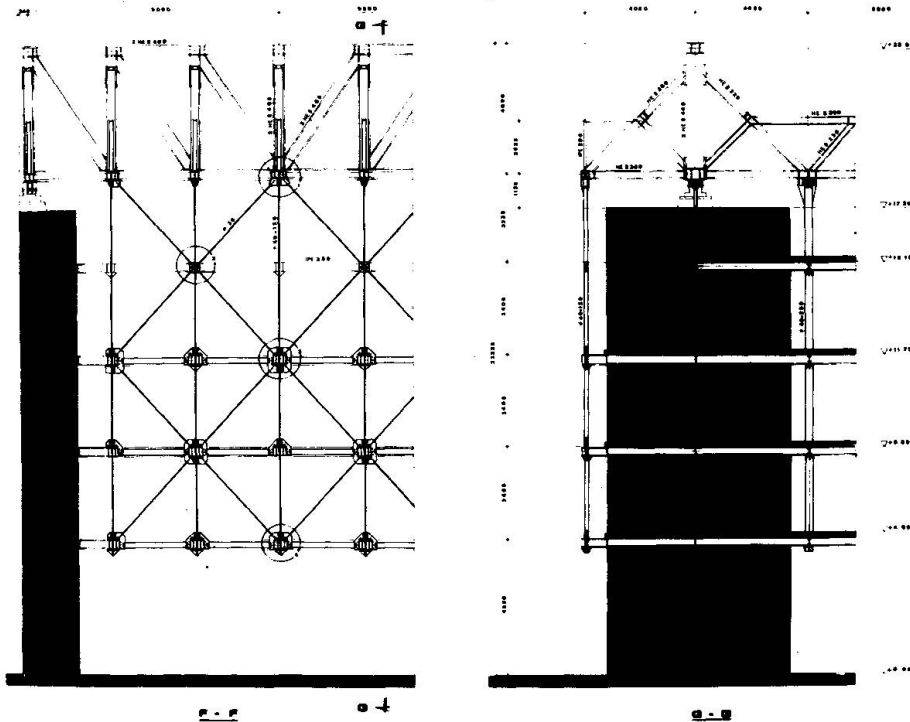

Fig. 2 - Longitudinal and transversal view of the suspended steel skeleton.

This solution was chosen in strict accordance with the architectural requirements which wanted to have a ground floor completely free of structural steel elements.

In the first approach the advantages of this kind of composite system were emphasized, by underlining that:

- reinforced concrete was used for stocky compression elements providing the main vertical and horizontal bearing function;
- steel was used for beams and ties forming the suspended skeleton which resist vertical dead and live loads.

No mention to seismic resistance because at that time Naples was not considered as a seismic area. In the meantime the important earthquake of November 1980 caused the insertion of this town in a new low risk seismic area. As a consequence, it was necessary to adapt the previous design to the new seismic requirements and it was decided to make it by keeping the same architectural solution of hanged construction.



The suspension composite structure was, therefore, interpreted at the light of the new seismic forces and made able to resist them. It was observed that the suspended steel skeleton behaves as a rigid body during the earthquake attack, undergoing vertical and horizontal displacements, transmitted by the isostatic vertical elements.

It seemed, first of all, necessary to fulfil the following requirements:

- the reinforced concrete towers must completely resist the horizontal quakes;
- the steel suspended structure must mainly resist the vertical quakes;
- horizontal and vertical movements must be free under serviceability conditions, but they must allow a proper energy absorption during the earthquake attack.

This last requirement has been satisfied by introducing special devices for seismic risk protection as supports of the suspension system on the top of each tower (see section 5). The dumping effect is obtained by the deformation of rubber layers together with the yielding of appropriate steel elements.



Fig. 3 - Longitudinal reticular girder erected on the top of the concrete towers.

### 3. STRUCTURAL SYSTEM

The building is composed by a ground floor and four raising floors. Its plan has an extended rectangular shape 26 meters wide, which is longitudinally subdivided following a modulus of 3 meters (Fig. 2).

The reinforced concrete towers, which are coupled in transversal sense, are spaced of 18 meters by forming a square mesh of 18x18 meters (Fig. 1).

The longitudinal reticular girders of the suspension system are simply supported on the top of the towers (Fig. 3). The transversal reticular girders are spaced of 3 meters in correspondence of the vertical members of the longitudinal girders (Fig. 4).

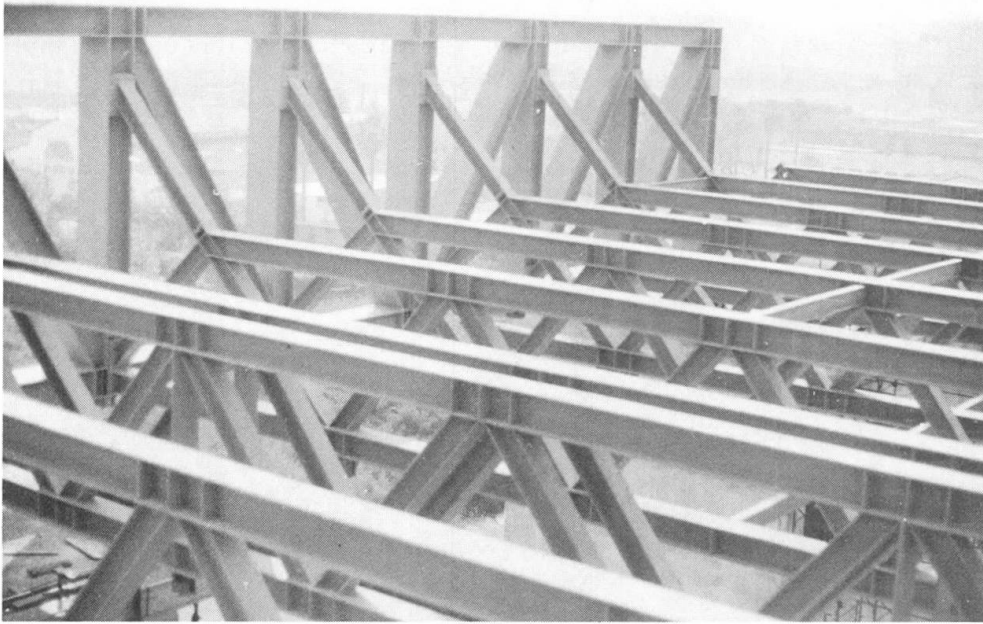

Fig. 4 - Transversal reticular girders of the suspension top system.

The suspension ties, which are hanged to the bottom chords of the reticular girders, support the floor structures at different levels (Fig. 5). Couples of transversal double T beams are suspended at each floor every 3 meters, which is the span of the corrugated sheets filled with concrete. The floor system, in which slabs are shear connected to beams and integrated with horizontal steel bracings, realizes a rigid element against horizontal actions. Vertical bracings are located on the longitudinal perimeter in external position in front of the curtain-walls (Figg. 2 and 6).

#### 4. CONSTRUCTIONAL DETAILS

The principal steel joints have been conceived as full strength connections [1,2]. The butt-welded solution has been adopted for the longitudinal and transversal girders of the suspension system. This led to complete pre-fabrication of the main girders in the workshop, followed by the transportation of wide (up to 18 meters long) and heavy (up to 33 tons) elements and the erection in their right position at the top level (Fig. 3).

The connection in situ are made by means of end plate and cover plate joints with high strength steel bolts in calibrated holes in order to practically eliminate any slip due to hole-bolt clearance.



Fig. 5 - Ties and floor beams hanged to the top grid.



## 5. SEISMIC DEVICES

Technical literature gives different solutions for base isolation systems both for concrete and steel structures [3 to 9]. They are mainly based on the use of rubber together with steel elements plastically working in shear, bending, torsion, etc.

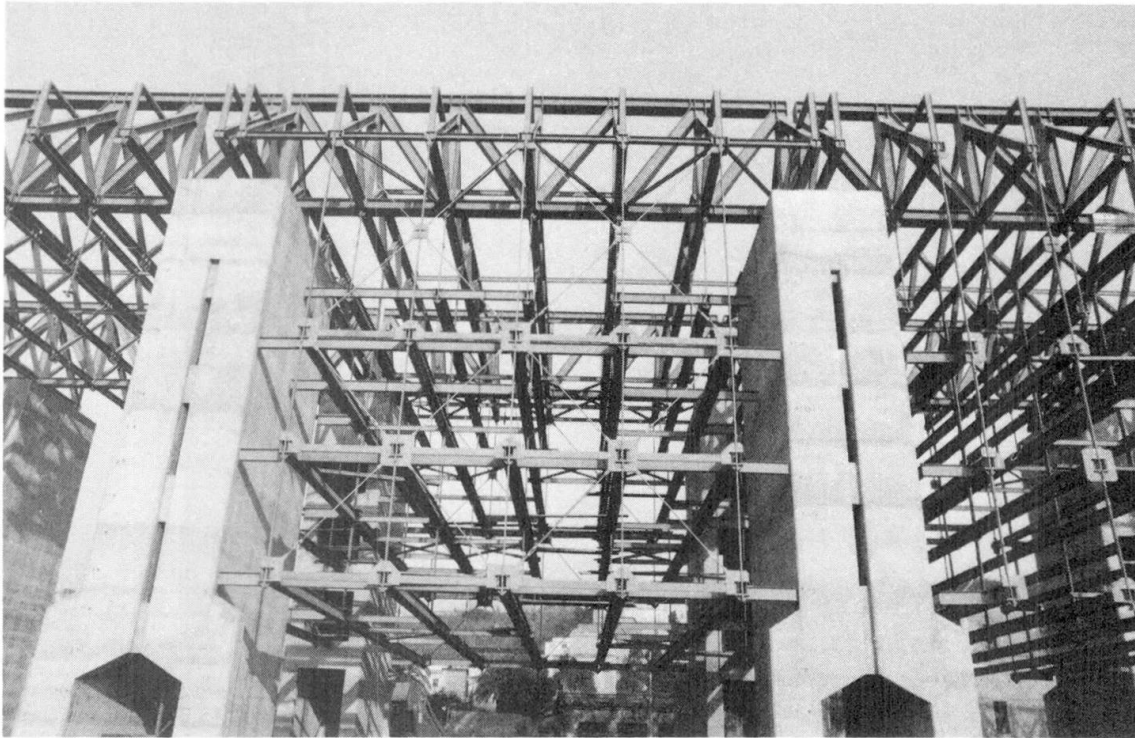

Fig. 6 - Lateral bracings between two towers.

In our case the steel skeleton containing the fire station will undergo horizontal and vertical movements which are transmitted by the concrete towers during the earthquake attack. This skeleton is considered the object to be protected by placing an isolation system at the base of the steel structure where there is the source of the shock.

The supports of the steel skeleton at the top of the towers must play a double function (Fig. 7) :

- a) to allow the free movements of structure when it is subjected to the service loads (dead and live loads, wind, temperature...);
- b) to damp the horizontal and vertical displacement when it undergoes the seismic attack.

Function a) is given by means of the usual supports which realize fixed or moving hinges.

Function b) is mainly directed to the vertical quakes because they seem to be rather dangerous for a suspended structure. It is obtained by introducing hysteretic dampers in conjunction with flexible layers made of rubber bearing pads (Fig. 8).

The dampers are based on the plastic deformation of steel elements, which absorb energy in two different ways. Due to vertical movements damper components undergo inelastic deformation in tension. Due to horizontal movements damper components inelastically deform in shear and bending.

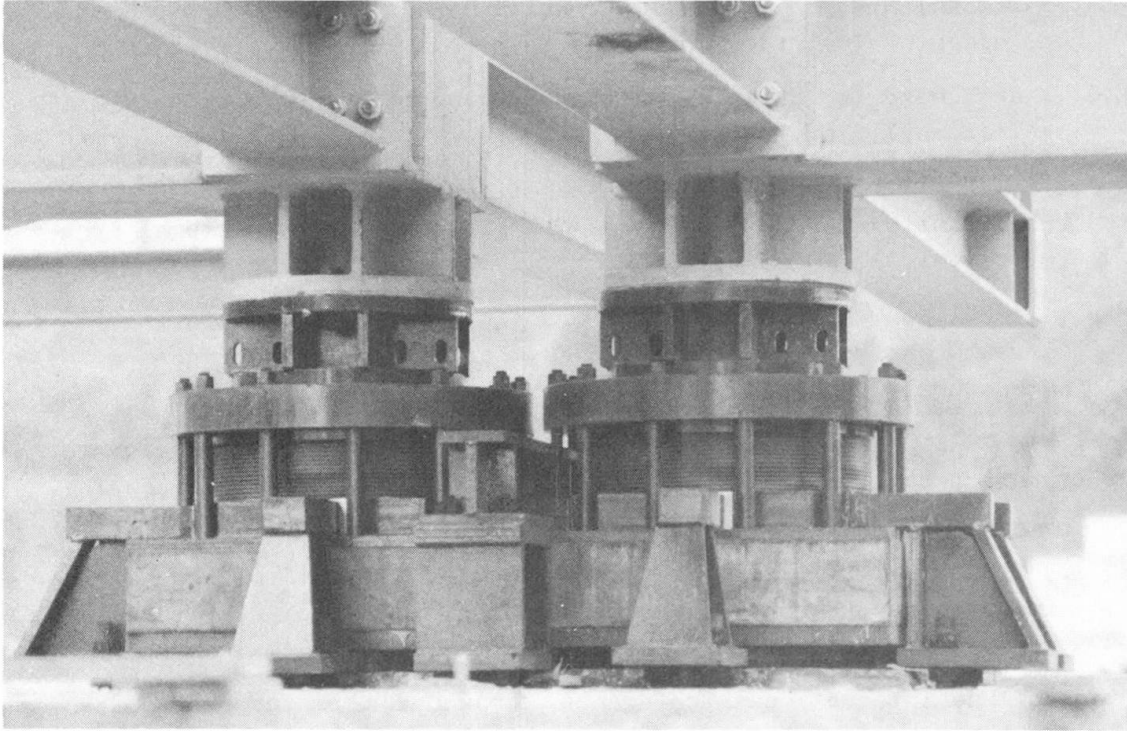

Fig. 7 - Seismic supports of the top grid.

Special devices are also introduced in the floor structure in order to create a flexible connection between the horizontal beams and the vertical wall of concrete towers (Fig. 9).

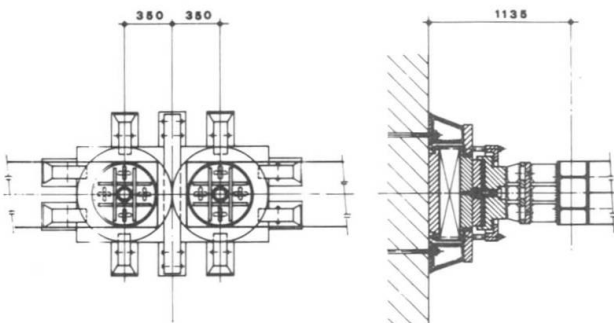

Fig. 8 - Constructional details of the seismic supports.

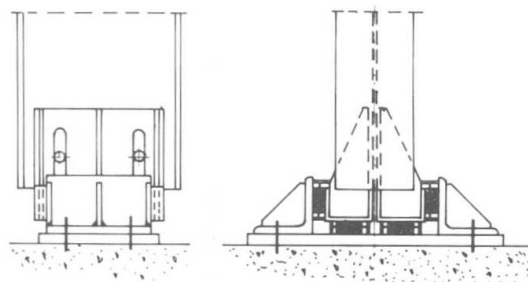

Fig. 9 - Constructional details of the floor devices.





## REFERENCES

1. BALLIO G., MAZZOLANI F.M., Theory and Design of Steel Structures. Chapman and Hall Ltd, London, 1983
2. BALLIO G., MAZZOLANI F.M., I collegamenti nelle strutture sismo-resistenti di acciaio. Italsider, quaderno tecnico n. 11/1980
3. CASPE M.S., Earthquake isolation of multistory concrete structures. ACI Journal, November 1970
4. SKINNER R.I., KELLY J.M., HEINE A.J., Hysteretic dampers for earthquake-resistant structures. Earthquake Engineering and Structural Dynamics, vol. 3, 287-296, 1975
5. SKINNER R.I., BECK J.L., BYCROFT G.N., A practical system for isolating structures from earthquake attack. Earthquake Engineering and Structural Dynamics, vol. 3, 297-309, 1975
6. ROBINSON W.H., GREENBANK L.R., An extrusion energy absorber suitable for the protection of structures during an earthquake. Earthquake Engineering and Structural Dynamics, vol. 4, 251-259, 1976
7. DERHAM C.J., EIDINGER I.M., KELLY J.M., THOMAS A.G., Supporti di fondazione in gomma naturale per la protezione dal terremoto: risultati sperimentali. NR Technology, anno VIII, n. 3 1977
8. Proceedings of the International Conference, Natural Rubber for earthquake protection of buildings and vibration isolation. Kuala Lumpur, Malaysia, February 1982
9. CONSTANTINON M.C., TADJBAKHSI I.G., The optimum design of a base isolation system with frictional elements. Earthquake Engineering and Structural Dynamics, vol. 12, 203-214, 1984