

Zeitschrift: IABSE reports = Rapports AIPC = IVBH Berichte
Band: 58 (1989)

Artikel: Expert system for tunnel design and tunnelling
Autor: Osaka, Hajime
DOI: <https://doi.org/10.5169/seals-44920>

Nutzungsbedingungen

Die ETH-Bibliothek ist die Anbieterin der digitalisierten Zeitschriften. Sie besitzt keine Urheberrechte an den Zeitschriften und ist nicht verantwortlich für deren Inhalte. Die Rechte liegen in der Regel bei den Herausgebern beziehungsweise den externen Rechteinhabern. [Siehe Rechtliche Hinweise.](#)

Conditions d'utilisation

L'ETH Library est le fournisseur des revues numérisées. Elle ne détient aucun droit d'auteur sur les revues et n'est pas responsable de leur contenu. En règle générale, les droits sont détenus par les éditeurs ou les détenteurs de droits externes. [Voir Informations légales.](#)

Terms of use

The ETH Library is the provider of the digitised journals. It does not own any copyrights to the journals and is not responsible for their content. The rights usually lie with the publishers or the external rights holders. [See Legal notice.](#)

Download PDF: 19.03.2025

ETH-Bibliothek Zürich, E-Periodica, <https://www.e-periodica.ch>

Expert System for Tunnel Design and Tunnelling

Système expert pour la conception des tunnels

Expertensystem für den Entwurf von Tunneln

Hajime OSAKA
System Engineer
Taisei Corporation
Tokyo, Japan

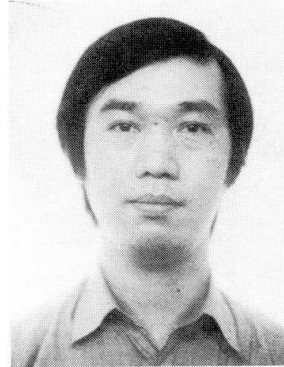

Hajime Osaka, born in 1947, obtained his degree of M.Sc. in Mathematics at the Tokyo Institute of Technology. For eighteen years, he has been actively involved in the fields of Geomechanics and Numerical Analysis. He, now in a general construction firm, is a senior administrator of information systems department.

T. Shinokawa, Sato Kogyo Corp., Japan
Y. Goto, Tokyu Construction Corp., Japan
T. Tsuruhara, Oyo Corp., Japan
Ö Aydan, Nagoya Univ., Japan
Y. Ichikawa, Nagoya Univ., Japan

SUMMARY

In this article, we describe an expert system for tunnel design, its structure and its features, and present some applications of the system. The system consists of four sub-expert systems (1 - ES for Standard Tunnel Design Methods, 2 - ES for Framed Structure Method, 3 - ES for Theoretical Design Methods, 4 - ES for Numerical Analysis Design Method), and a common part to control the overall system and two data-base systems (1 - Tunnel Data - Base System, 2 - Rock Mass Data - Base System).

RESUME

L'article présente le système expert pour la conception des tunnels ainsi que sa structure et ses caractéristiques, ainsi que quelques applications. Ce système se compose de quatre sous-systèmes experts 1: Sous-système expert pour la méthode standard de conception des tunnels; 2: Sous-système expert pour la méthode de structure charpentée; 3: Sous-système expert pour les méthodes de conception théorique; 4: Sous-système expert pour la méthode de conception par analyse numérique. Le système comprend aussi une partie commune contrôlant le système ainsi que deux systèmes de bases de données 1: Système de base de données pour les tunnels; 2: Système de base de données pour des roches.

ZUSAMMENFASSUNG

Im vorliegenden Aufsatz beschreiben wir unser Expertensystem für den Entwurf von Tunneln und führen einige Anwendungsbeispiele auf. Es besteht aus vier Expertenteilsystemen (1. Standardmethoden des Tunnelentwurfs, 2. Rahmentragwerksverfahren, 3. Theoretische Methoden des Tunnelentwurfs, 4. Numerische Analysemethoden des Tunnelentwurfs), einem gemeinsamen Teil für die Kontrolle des Gesamtsystems und zwei Datenbanksystemen (1. Tunnelbau-Datenbanksystem, 2. Gebirgsmassiv-Datenbanksystem).



1. INTRODUCTION

The design of geotechnical engineering structures generally involves many elements of experiences. The reason for this is due to the difficulty of evaluating the true mechanical behaviour of ground at the stage of designing. This is well-pronounced in the case of tunnel design. The design in many cases is carried out with insufficient information on the geology and the mechanical behaviour of the ground and through some simplifications regarding the geological structure and the mechanical modelling of the ground on the basis of experiences of specialists. The decisions differ from one to another depending upon the purpose of tunnelling, the objective of designing, the accuracy of available input data, the effect of designing on construction procedures and social constraints. In addition, the experiences of the designers influence the decisions up to a great extent. To use past experiences on a tunnel, the investigation of a number of items are usually necessary and even sorting out the investigated items present a great amount of work and difficulty.

As expert systems (called ES hereafter) have become popular in recent years, we have started to investigate how to systemize the experiences and decision making procedures of experts in tunnel design. In our study, we are mainly concerned with tunnel construction procedures by the New Austrian Tunnelling Method (NATM), since the NATM is the most widely used tunnelling technique in Japan.

The authors have constituted a joint research group under the leadership of Nagoya University, involved with the tunnel design, and their experiences are systemized for the development of Expert System (ES) for the design and construction of tunnels (the project for developing the tunnel expert system: TUX project). The present work has been carried since April 1986 till March 1989 and we herein present some outcomes of our work up to now. The joint research group have been consisted of 20 people closely involved with the design of tunnels and the work has been carried out with the close collaboration of the members. Firstly, the steps and elements of design procedures were carefully investigated and, on the basis of this investigation, the levels of main steps of design procedures were then defined. As a result of these studies, the expert system (ES), consisting of four sub-expert systems has been developed. The sub-expert systems are; Expert system for the tunnel design standards; Expert system for the analytic tunnel design methods; Expert system for the design of tunnel supports by the framed structure method; Expert system for the numerical analysis. At the same time, tunnel and support data-base systems and rock tests data-base system have been developed using micro-computers as it was concluded that it would be necessary to accumulate and store the experiences with the ES.

2. SELECTION OF THEMES OF DEVELOPMENT

The present expert systems are concerned with functioning either as a specialist and/or dealing with uncertainties. Though the functioning of the system as a specialist involves some kind of uncertainty, the systems can be usually classified to one of the classes depending upon their objective. Our expert system is concerned with functioning as a specialist.

Tunnel design concept has undergone a great transformation with the introduction of the New Austrian Tunnelling Method (NATM) and the construction equipments and procedures have been renewed as a result. The main principle of the NATM is associated with the effective use of the circuit of Investigation-Design-Construction steps as compared with the conventional design. The principles of the NATM are very logical and it incorporates the experiences of engineers in the all steps of the tunnel construction. Japan Society of Civil Engineers (JSCE) has designated the NATM as the standard tunnel design & construction method and tunnel constructions by the NATM are expected to increase more and more. For the further development

of the NATM as more economical and rational method, it is necessary to develop more effective numerical and theoretical analysis methods, optimum control values, to establish design alteration procedures, to check the suitability of the employed design and to accumulate the experiences. Therefore, a data gathering and a unified NATM design and construction system is considered to be necessary. This system should have mechanism to incorporate not only the experiences but also new technical developments. The ES based on the artificial intelligence concept is thought to be suitable for such a purpose.

The research group first analysed the tunnel design items and the associated procedures. The tunnel design can be classified into two stages; the design before construction (initial design) and the design during construction. It is a problem to design tunnels rationally on the basis of little amount of geological and experimental data. However, it is possible to do more accurate designs with the information gained from the performance of the tunnel and the observation of the face. In the design during construction, though the procedure is also the same as that in the initial design, the interpretation of measurements and the observation of the face are included. The present work is mainly concerned with the initial design. Fig. 1 shows the NATM design flow chart, which is concluded from the analysis of the initial design procedures.

The features of each procedures and the sistemized items are as follows.

(1) Data input

The first step is sorting and checking information for design which are defined as input data. The input data used in the tunnel design generally involve design conditions such as dimensions and the geometry of the tunnel, environmental constraints, geological decisions from geologic and past-record surveying, boring and core testing and ground classifications based on elastic wave velocity measurements. As the amount of data is too large and necessitate a great deal of labourship, the necessary data items are only included in the system in association with the capability of the present system.

(2) Determination of design method

Depending upon the ground conditions and the scale of the tunnel, the operation to determine the suitable design method from the input data is carried out. Presently this operation is left to the designer. The operation involves highly expertise knowledge and it is simplified in the present system.

(3) Determination of standard support pattern

The determination of the standard support pattern is concerned with the methods based on case studies and ground classifications. The determination of the support pattern from experimental studies during driving exploration adits or test adits is excluded in the system as this is involved with the concept of the design during construction. The ground classifications for the determination of the standard support patterns are installed in the system. The presently built-in classifications are the classification of Japan Roadway Association for roadway tunnels and the classification of Japan Railways for railway tunnels. The determination of the support pattern by the case studies is based upon the tunnelling data base system. The tunnelling data base system stores records of past tunnel constructions and the search are carried out through key-words and the support pattern is selected for the problem handled. The items have been still sorted. In addition, the examination of the counter measures for seepage and face instability are considered to be carried out at this level.

(4) Evaluation

The content of the evaluation is very large and there are various alternatives. More specifically, Some of these alternatives are as follows: 1-) A more detailed examination of items of the chosen standard support pattern, 2-) Decisions regarding the necessity to alter the chosen support pattern or the choice of the design method following the stability analysis, 3-) Exam-



ination of any item of input data or information is lacking or not. This part of the system is closely associated with the decisions based on the experiences of specialists. As the scope is too large to systemize, the present version of the TUX system covers the decision if there is any need to examine the chosen standard pattern and the selection of the stability analysis method.

(5) Stability analysis

The methods for stability analyses are well-established and programmed. This part of the work is associated with data preparation and the experience to evaluate the calculated results. Stability analysis methods consist of i-) Stress analysis of support members subjected to loosening loads, ii-) Limit equilibrium analysis of the bearing capacity of rock arch, iii-) Closed form solutions for the stability of ground and support members, iv-) Model tests, and v-) Numerical methods (FEM, BEM). In the present version of the TUX system, the model test method is excluded.

(6) Detailed Design

This operation involves the detailed design of elements following the primary support system. The elements in these category are the design of concrete linings, of portals, of waterproofing and drainage. The examination of construction methods, setting the control values and the evaluation of environmental effects are necessary in this stage.

As noted in Fig. 1, there is no arrows among the operation stages to indicate a certain flow path. This is due to the reason that the system should be flexible to incorporate several alternative paths effectively depending upon the conditions of each tunnelling problem handled. This is the usual procedure in experience-based designs. It is difficult to handle with various paths by the use of ordinary methods. On the other hand, this type problems can be easily dealt with the ES easily.

The development environment used in building the ES is the VAX_AI Station of the Digital Equipment Corporation (DEC) and the tool for the ES is OPS5. The computations are done using the existing but renewed programs written in FORTRAN.

3. SYSTEM OUTLINE

The structure of this tunnel design ES (TUX) is shown in Fig. 2. The TUX consists of a common & control section and several sub expert systems; i-) ES for standard design methods, based on ground classifications, ii-) ES for theoretical design methods, based on closed form solutions, iii-) ES for framed structure design method, based on the framed structure analysis of the support members and loosening load concept, iv-) ES for numerical analysis design method, based on the numerical analysis by finite element method (FEM). The TUX is presently built for the use in Japan and the presentations of conversations between users and the knowledge bases and the rules are all in Japanese.

3.1 Control and Commonly-referred Section

The control section of the TUX is to control the rules to execute each appropriate design method and to enable input of arbitrary tunnel shape and support pattern. The commonly-referred section consists of a knowledge base to determine material properties of ground and support members. In the judgement of ground conditions, the conditions such as expansion-ability or flowability of surrounding rock mass etc. are evaluated. The definitions of tunnel dimensions are shown in Fig. 4 and patterns of support systems are given in Table 1. However, the support system can be also input besides the support patterns chosen from the classifications. As for ground properties, an estimation procedure for the material properties of support members is available and Table 2 shows the units of the knowledge base. Each unit of the knowledge base is composed of several rules, and if they are called from other knowledge bases,

they send back results after applying the rules for the input information at the time of calling. And it checks whether the required data is available or not. If the data is not available, then it seeks for a knowledge base, in which the the required data is possible to be found. Then, the knowledge base is again applied to the data. A simple example is shown in Fig. 3. The knowledge base for the determination of the ground deformation modulus consists of a sequence of knowledges regarding the procedure how to determine the deformation modulus. As a specific example, the modulus is determined from the modulus of rock element and jointing index. If that rule is executed, then the corresponding knowledge base is called. The called knowledge base first checks whether the required data exists or not, if not found, then it calls the knowledge base, in which it can be found. Once the modulus of rock element and jointing index are available, then it evaluates the modulus of ground and send it back to the knowledge base which has required that information. The smallest unit of knowledge bases corresponds to the knowledge of experts for each theme. In this case, the definition of the formulae to determine the ground modulus from the modulus of rock element and jointing index is a knowledge base together with the limitations of these formulae. The ES is evolving by accumulating this type of contents.

3.2 ES for Standard Design Methods

The classifications of Japan Railways and Japan Roadway Association are the standard design methods for tunnels in the respective tunnel types. A sub-expert system has been developed for the tunnel design, based on the ground classifications and the standard support patterns for each respective class, developed by the above associations. The system consists of ground classifications and the determination of the tunnel shape and support pattern corresponding to each ground class. These classifications are outcomes of numerous actual tunnel construction practices. The name of rocks, their elastic wave velocity and the ratio of strength to overburden stress are fundamental data for the stability analysis and the TUX provides a data-base of the existing tunnels. A knowledge base is installed for searching the data-base and treating exceptional cases. There are several tunnel standard cross-sections provided by each respective authority, which are the elements of the knowledge base for the dimensions of tunnel shapes as shown in Fig. 4. The support system is determined from the dimensions of the tunnel cross-section and rock classes together with the information on excavation conditions and the installation patterns of support members. These relations are all installed in the system as a knowledge base.

3.3 ES for Theoretical Design Methods

There are several simple closed form solutions suggested for the tunnel designs by NATM. Of these, the methods suggested by Einstein, Egger and Oka are installed in this sub-expert system. The TUX first selects the calculation method from the input conditions given in Table 3. Then, the modelling of ground, in which the strength and deformation properties of ground are determined by using the determination function of the commonly-referred section for ground properties, is done automatically as brittle, perfectly-plastic or strain-softening plastic type. The tunnel shape is approximated as a circle and the support pattern is modified for that shape. For the material properties of support members, the commonly-referred section is used. Once the data are ready, the stress state, tunnel wall displacements and the plastic zone radius are calculated. Then, the check on the appropriateness of the support pattern is carried out by comparing the resistances of support members with the calculated results. The comparison method is shown in Fig. 5.



3.4 ES for Framed Structure Design Method

As a design method of the support system, a framed structure modelling is employed, in which loads are determined from loosening load concept. This sub-ES is coded as shown in Fig. 2. In the system, "the construction state" involves the data for the excavation steps and the hardening state of shotcrete in relation to the tunnel face advance. In setting the calculation case, the conditions for the installation timing of the support members, the excavation method and the presence of the primary and secondary linings are determined. The condition for the element divisions of support members, their material properties and boundary conditions are set. To determine the ground reaction coefficient, the system provides a knowledge base with various experimental data. The loads to act on the support members are determined from the Classification of Terzaghi in relation with the Classification of the Central Research Institute of Electric Power Industry of Japan. The calculated results are the displacement, the axial and shear forces and the moment of support members. An example is given in Fig. 6. From these figures, the stress intensity and displacement of the members are checked.

3.5 ES for Finite Element Analysis (FEM)

For more complex problems, numerical analysis methods are used for the stability analysis. In the TUX, a general finite element program is installed. This program treats the rock mass as a elastic medium under plain-strain condition and takes into account the effect of the face advancing. The face advance conditions involve the variations of support patterns and the material properties of the support members in relation with the initial-stress release rate. When the overburden is shallow and/or adjacent structures are present or the opening is very large, the numerical analysis methods are usually used. In the TUX, the mesh generation, the modelling of ground and support members, the setting of the analysis domain and the presentation of the calculated results are all done automatically. The analysed cases are the same as those in the case of the framed structure ES. The setting of the analysis domain is done with a minimum number of elements while taking the care of accuracy of the calculations. When the overburden is shallow, the inclination of the surface is also taken into account. The material properties of ground and support members are determined from the knowledge base of the commonly-referred section of the system. In determining the initial stress state, the value of the poisson ratio is assigned by using a rule of experience. A knowledge base is available for the stress release rate function, which is determined from 3-D FEM analyses, for simulating the effect of the face advancing. The ground, rockbolts, steel ribs, shotcrete and concrete lining are represented by 4-noded isoparametric elements, line elements and 4-noded isoparametric elements with the use of the reduced integration technique respectively. The calculation scheme models the simulation of the face advance and excavation states and the calculated results are displayed and/or output as the distributions of displacements, stress in ground and support members and safety factor. Fig. 8 shows the examples of the distributions of safety factor contours after the excavation of the upper and lower-half sections respectively.

It is difficult to write the rules of experiences for the evaluation of the results of the finite element analysis as the evaluation is generally done after seeing the distributions of stress and displacement and safety factor contours. Presently, the evaluation scheme for the finite element calculations is still being installed in the TUX. The results shown in Fig. 8 are obtained after 30 minutes using the TUX.

4. Evaluation of the ES

The TUX has the function of carrying out an automatized design as it generates the necessary data for the tunnel design from the knowledge of experiences. To activate the TUX, the minimum amount of data are; the purpose of use (roadways, railways, etc.), rock name, elastic wave velocity of ground, the type of the standard tunnel cross-section, overburden, inclination of the ground surface and the pull-out capacity of each bolt. If these data are supplied, then the TUX deduces the tunnel shape, and the support pattern and carries out the stability check analysis. Still some problems exist for inexperienced users in regard with the present automatized system. The current system can be regarded as an additional support tool for the experienced designers and can be used as a tool for the education of inexperienced users under the supervision of the experts.

During the development of the TUX, we have understood the true features of expert systems; some parts were well-established while the others were needed to be revised and re-written. We state our opinions about these as follows. The merits of expert systems of the TUX type can be said to be:

(1) Deduction Ability

As the ES has its own deduction system to deal with the rules of experience, there is no need to prepare another special routines for this purpose. This feature is particularly important in the application when no fixed procedure is available for the problem.

(2) Object-orientated structure

The ability of the detailed checking of the small elements of the knowledge bases is more powerful than that by conventional programming techniques. This, in turn, enables to easily code and check the program in segments separately.

(3) Easy understanding

The description of rules is close that in human language so that it is easy understand once one knows how to read.

(4) Certainty factor and fuzzy theory

It is possible to incorporate the decision making procedure by the use of the certainty factor concept or the fuzzy theory. The certainty factor and fuzzy have been introduced by Imazu⁴ and Shimizu⁵ for the rock classification expert system respectively. These approaches can be easily introduced for the determination of properties of ground and the evaluation of the calculated results.

As it is clear from the above statements, the easiness of extending the system is the most important feature of the ES. This becomes particularly important in further development of the large scale expert systems such as the extended TUX involving the management and measurements in tunnelling as well.

A revision of the TUX in future is considered to be closely dependent on the development of the tunnel data-base system. We have presently developed data-base systems for tunnels and rock properties, using the personal computers, which are independent of the TUX.

The tunnel data-base system has been developed with the objective of checking the design with reference to experiences gained in the existing tunnels under the similar ground and environmental conditions. Table 4 gives the items of the data-base system. The rock property data-base system has been developed with the purpose to refer the properties of ground. The items of the data-base system are given in Table 5. Presently, the data gathered from 96 tunnels in Japan has been stored in the tunnel data-base system. While the rock property data-base system has 1300 data. The data gathering process has been still continued. How to use these data-base systems in connection with the TUX has been presently discussed and remains as a problem to be solved.



5. CONCLUSIONS

We have developed an automatized tunnel design system (called the TUX - Tunnel Expert System), based on the ES concept. It can be used by anyone who does not have sufficient knowledges of carrying out theoretical, framed structure or numerical analysis. Of course, there are several approaches how to position the ES in civil engineering. One of those is that the ES can be considered to act as an effective connection tool among Design - Construction - Research (Fig. 8). By starting to develop an expert system for the purpose of design and construction, we have been able to sort out the rules of experience up to this extent. By the application of the system to actual examples, more research themes will appear. In addition, more research topics are expected to come into being at the time of coding the gathered actual examples in the ES. By coding the outcomes of these research topics in the ES will reflect themselves in design and construction. Nevertheless, this is only possible with the long-term contribution of numerous researchers and engineers. It is expected that the ES with the reflected outcomes in the above cycle will make themselves to function more smoothly and effectively.

It is a pity that the present system has not reached the above ideal state yet. This is partly due to the ability of the team members and partly due to insufficient development environment. Particularly, the problem regarding the cost and the user-interface of the ES is great in the development of the system with the help of a numerous engineers. Nevertheless, we expect that this problem will be overcome quickly in the near future.

Acknowledgements

The present research work has been jointly carried out from April, 1986 to March, 1989 by Nagoya University and Private Construction Companies under the Grant in Aids for Developmental Scientific Research, the Japan Ministry of Education (Monbusho). The authors wish to extend their sincere thanks and gratitudes to Prof. Dr. T. Kawamoto, Nagoya University for his supervision and the members of the research team for their continuous contributions and the Japan Digital Equipments Corporation (DEC) for their co-operation and help.

References

- 1- JSCE ed. : Tunnel standards manual (Mountain tunnels), Tunnelling Committee of Japan Civil Engineers (JSCE), 1986.
- 2- Japan Roadway Association: Tunnels in Design Manual, Chapter 9, Vol. 3, 1985.
- 3- Japan Railways (JR): NATM Design & Construction Manual, Japan Railway Construction Committee, 1983.
- 4- Imazu, M. : Rock classification by using expert system. Procs. of the 19th Rock Mechanics Symposium, 1987.
- 5- Shimizu, N. : A research on rock classification by using fuzzy theory. Procs. of JSCE, No. 370/III.
- 6- Kawamoto, T. ed.: An expert system for tunnel design and construction. Research Rep., Project No. 61302060, Grant in Aids for Developmental Scientific Research, Japan Ministry of Education (Monbusho), 1989 (under preparation).

Table 1: Data for support pattern

Class	Name of data item
Excavation Conditions	Excavation method
	Advance ; Length of round
Rockbolt pattern 1	Rockbolt installation type
	Rockbolt length
	Rockbolt number
	Rockbolt diameter
	Rockbolt transverse spacing
	Rockbolt longitudinal spacing
Rockbolt pattern 2 (Two type rockbolt installation patterns are possible)	Pull-out capacity
	Rockbolt installation type
	Rockbolt length
	Rockbolt number
	Rockbolt diameter
	Rockbolt transverse spacing
Shotcrete	Rockbolt longitudinal spacing
	Pull-out capacity
	Definition method for shotcrete thickness
Steel ribs	Shotcrete thickness (Upper)
	Shotcrete thickness (Lower)
	Steel rib type
Concrete Lining	Area of the cross section (Upper)
	Area of the cross section (Lower)
	Installation spacing
Allowed displacement	Thickness of arch and wall sections
	Thickness of invert
	Allowed displacement (Upper)
	Allowed displacement (Lower)
	Allowed displacement (invert)

Table 3: Setting of design cases

Initial stress	Behaviour	Calculation method
Non-hydrostatic	Elastic	Einstein
	Elastic-perfectly plastic	Einstein Egger
Hydrostatic	Elastic-strain softening plastic	Egger Oka
	Elastic-brittle plastic	Egger

Table 4: Items of tunnel data-base system

Content	Item
Tunnel	tunnel number, tunnel name, location, tunnel type, tunnel length, length by NATM, existence of adjacent constructions, existence of junctions, dates of commencement and completion of tunnel, referred article
Geologic Conditions	geologic age, geologic class, upper & lower elastic wave velocities, rock name, rock classification and classes, max. amount of seepage seepage period, expansibility, flowability, unusual loads, existence of faults & fractured zones, existence of landslides, overburden
Design Conditions	excavation methods, excavation types, diameter of excavation, excavation area excavation advance length, rockbolt (length, number, spacing) steel ribs (upper-half, lower-half, spacing), shotcrete (thickness, strength), existence of Bernold sheets, existence of steel-fibre, concrete lining (invert, arch, side-walls)
Instability	contents of instability, auxiliary methods
Monitoring	max. displacement, max. crown convergence, pull-out resistance of bolts

Table 5: Items of rock-mass data-base system

Content	Item
Rock	Construction name, location, geologic age, formation name, rock name
Geologic Conditions	classification name and classes, V_p & V_s of rock mass, V_p & V_s of rock
Test data	excavation method, support pattern name, excavation area, unit weight, compressive strength, elastic modulus (E_{50}), Poisson's ratio, friction angle, cohesion, N-value, RQD, referred article

Table 2: Knowledge base for determining ground properties

Item	Data to be determined	Determination method
Ground Properties	Unit weight	Input of test value
	Longitudinal velocity V_p	Input of measured value
		Shear velocity V_s
	Ground strength	Input of test value
		Modification of rock strength by jointing index
		Determination from CRIEPI classification
	Initial stress	Overburden x Unit weight ($\gamma \times H$)
	Lateral stress coefficient	Input of measured value
		Estimation from Poisson's ratio
	Deformation modulus	Input of measured value
		Modification of elastic modulus of rock by jointing index
		Modification of dynamic elastic by Kujundzic's method
	Poisson's ratio	Estimation from CRIEPI classification
		Input of measured value
Use of dynamic poisson's ratio		
CRIEPI's class	Estimation from Ikeda's classification	
	0.3	
	Input of user decision	
Ikeda's class	Estimation from wave velocity	
	Input of user decision	
	Rock name and wave velocity	
Rock Properties	Strength	Input of test value
	Deformation modulus	Input of test value
	Wave velocity	Input of measured value

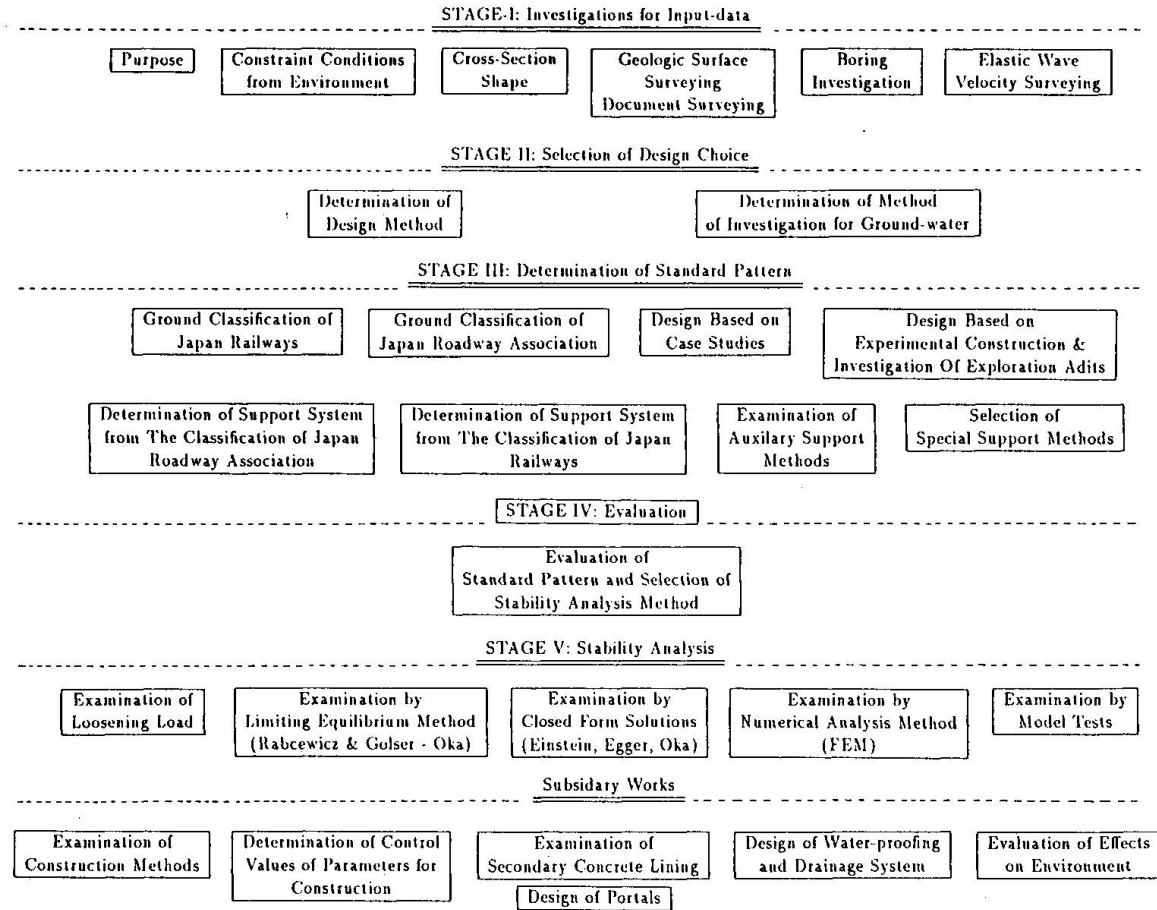

Fig. 1: The flow chart of the tunnel design procedure by the NATM

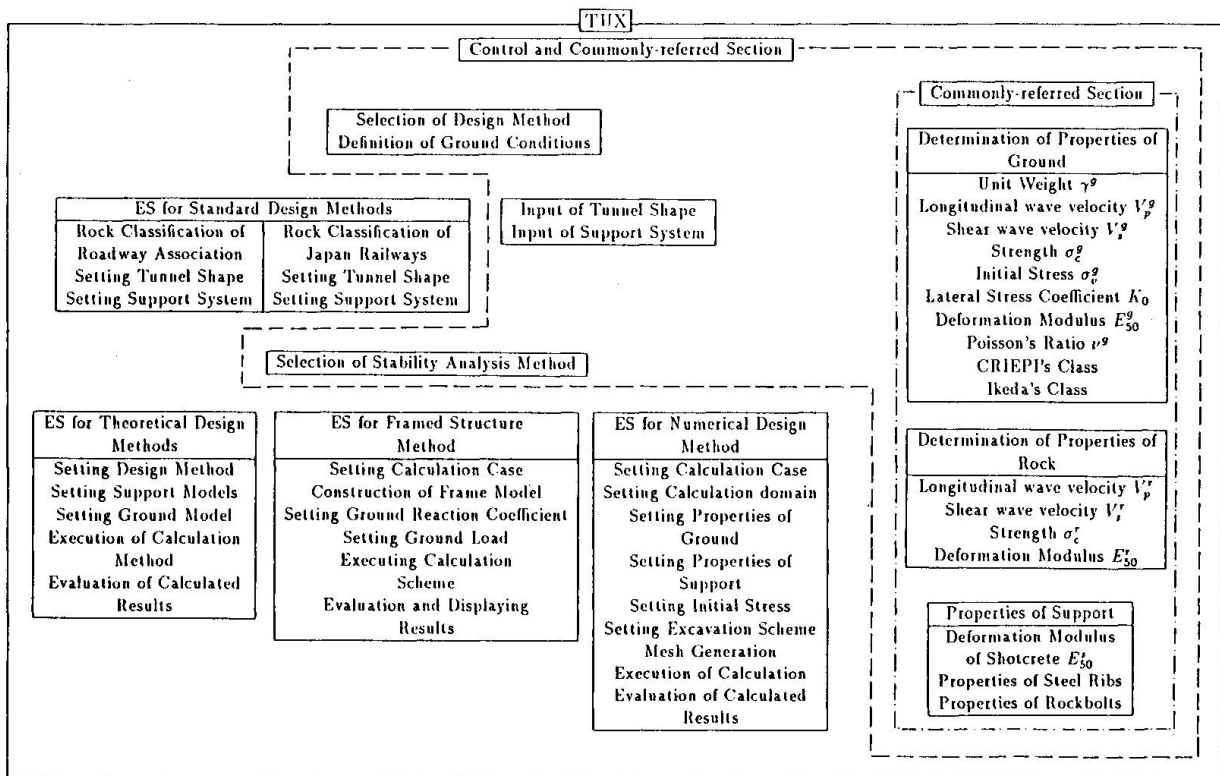

Fig. 2: The outline of the tunnel design expert system - TUX

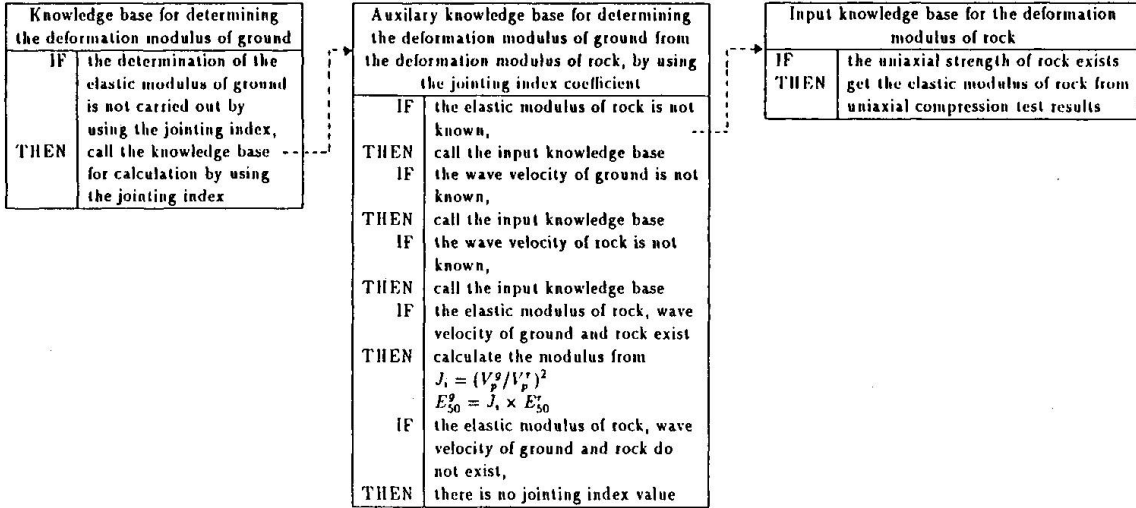

Fig. 3: Calling scheme of knowledge bases

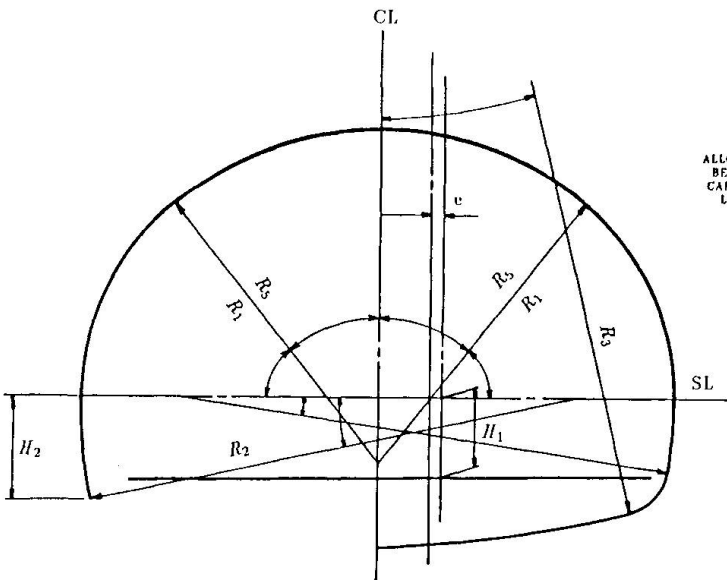
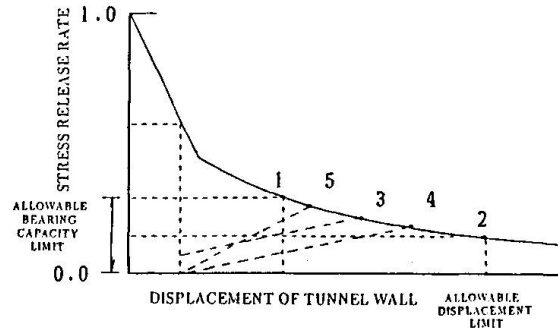

Fig. 4: Definition of dimensions of a tunnel



CALCULATION CASES	
No	Calculation conditions
1	support members are subjected to their ultimate resistances
2	tunnel wall displacement is allowed up to the limit of the allowed displacement
3	rockbolt loads with a prestress equal to the pull-out capacity, shotcrete and steel ribs to behave elastically
4	rockbolts without prestress, shotcrete and steel ribs to behave elastically
5	rockbolts, shotcrete and steel ribs to behave elastically

Fig. 5: Analysed cases (Theoretical Design Methods)

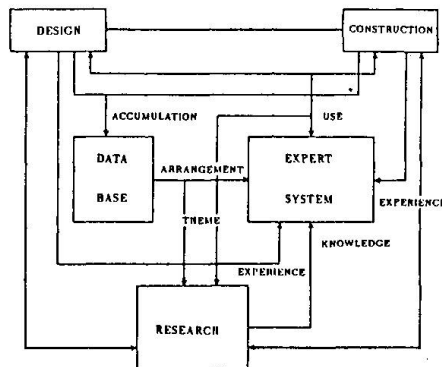

Fig. 8: Relation between the Expert System and the Design - Construction - Research Cycle

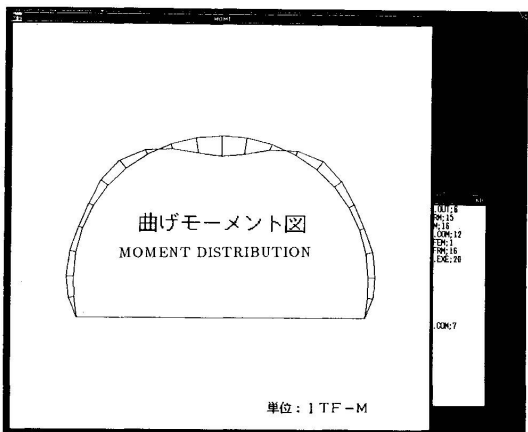
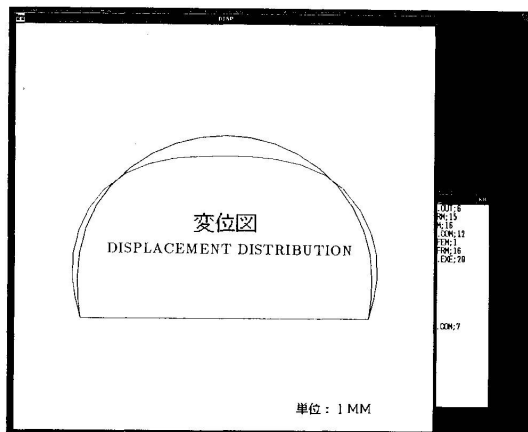

Fig. 6: Displayed calculation results (Framed Structure Design method)

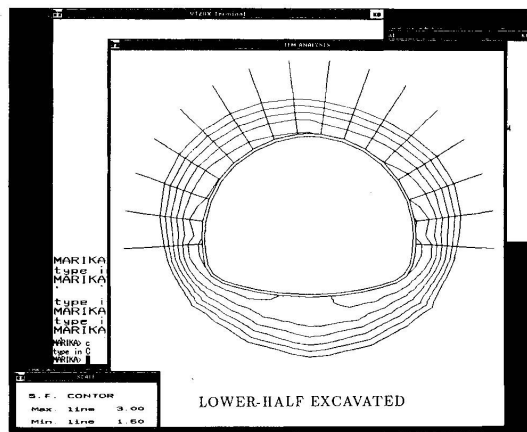
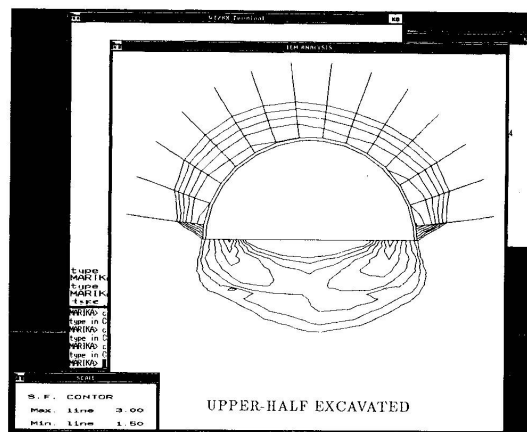

Fig. 7: Displayed calculation results (Numerical Analysis Design Method - FEM)

