

Zeitschrift: IABSE reports = Rapports AIPC = IVBH Berichte
Band: 64 (1991)

Artikel: Cable-stayed bridge in a typhoon area
Autor: Wenzel, H.
DOI: <https://doi.org/10.5169/seals-49345>

Nutzungsbedingungen

Die ETH-Bibliothek ist die Anbieterin der digitalisierten Zeitschriften. Sie besitzt keine Urheberrechte an den Zeitschriften und ist nicht verantwortlich für deren Inhalte. Die Rechte liegen in der Regel bei den Herausgebern beziehungsweise den externen Rechteinhabern. [Siehe Rechtliche Hinweise.](#)

Conditions d'utilisation

L'ETH Library est le fournisseur des revues numérisées. Elle ne détient aucun droit d'auteur sur les revues et n'est pas responsable de leur contenu. En règle générale, les droits sont détenus par les éditeurs ou les détenteurs de droits externes. [Voir Informations légales.](#)

Terms of use

The ETH Library is the provider of the digitised journals. It does not own any copyrights to the journals and is not responsible for their content. The rights usually lie with the publishers or the external rights holders. [See Legal notice.](#)

Download PDF: 30.03.2025

ETH-Bibliothek Zürich, E-Periodica, <https://www.e-periodica.ch>

Cable-Stayed Bridge in a Typhoon Area

Pont haubané dans une région exposée au typhon

Schrägseilbrücke in einem taifungefährdeten Gebiet

H. WENZEL

Dr. Ing.
VCE – Vienna Consult. Eng.
Vienna, Austria

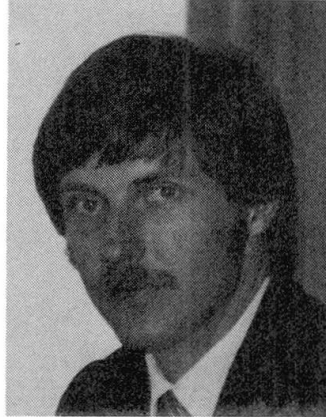

Helmut Wenzel, born 1950, obtained his engineering degree in Austria. For the last 15 years he has been engaged in bridge design and supervision in the Middle and the Far East.

SUMMARY

Long span bridges are generally considered to be special projects, that require special materials and design procedures. This paper reports on a large bridge, where it was tried to use only well-developed methods and materials to suit the local construction industry in a newly industrialised country. This leads to new types of structures, that are briefly discussed.

RESUME

Les ponts de grande portée sont considérés en général comme des projets spéciaux, nécessitant des matériaux et des méthodes de projet particuliers. Cet exposé présente un projet pour lequel on a essayé d'utiliser uniquement des matériaux et des procédés standards disponibles dans un pays en développement. Cela conduit à de nouvelles solutions pour les structures porteuses.

ZUSAMMENFASSUNG

Weitgespannte Brücken werden allgemein als Sonderbauvorhaben betrachtet, bei denen besondere Materialien und Entwurfsmethoden zur Anwendung kommen. Dieser Beitrag soll von einem Projekt berichten, bei dem darauf geachtet wurde, dass nur bereits vorhandene Standardmaterialien und -vorgänge angewandt werden, wie sie in einem Schwellenland erprobt sind. Dies führt zu neuen Lösungen für die Tragwerke, die hier diskutiert werden.



1. GENERAL REMARKS

The study, on which this paper is based on, was carried out for a definitive project in Taiwan. The figures and facts discussed here are therefore valid for this project only. However it can be assumed, that the results are valid, showing slightly different values, for other regions and conditions.

1.1 The Project

The total length of the bridge will be approximately 1000 meters. The free span shall be 600 meters. The width is intended to be 23.80 meters, which covers 4 lanes. The ground conditions are assumed to be an overburden of 35m, consisting of gravel and sand, on the solid rock layer. The foundations will be concrete wells made of slurry walls, and will not be altered for the different proposals. The figures therefore consider only the facts for the pylons, piers and the deck structure.

1.2 The Technical Feasibility Study

The first question raised by a client when he is confronted with such a record braking structure is about the technical feasibility. However it is pointed out, that the project shall be executed considering the local conditions, particular material availability and construction methods, as well as the extraordinary conditions of seismic activities and frequent typhoons happening in this area.

For a practicable design this means the following tasks :

- Try to use well developed materials i.e. existing types and dimensions of cables (111 parallel strand cable or locked coil cable of diameter 167mm, ultimate load 28000kN each)
- Use the local materials and allow the usual capacities only. (Concrete BN35 (DIN 1045), Reinforcement steel grade 60, Strands 1570/1770, Structural welding steel SWS50)
Don't ask for extraordinary strength or performance
- The unexperienced local construction industry should be able to execute the project in cooperation with a foreign Know How partner, that delivers also the few items to be imported
- Items that can be executed by a few foreign special firms only, such as spinning cables for a suspension bridge shall be avoided.
- Shipment and transportation of oversized parts shall be avoided and items shall be assembled on site (i.e. cables)
Assembly shall be feasible on site using local sources.
- Maintenance and repair shall be easy and economic.

For a bridge of span 600m we have the choice between a cable stayed bridge and a suspension bridge. Being too long for a normal cable stayed bridge and too short for a suspension bridge it was obvious to try a combination, taking the best of both methods. The 3 proposals shown on the next page consider above mentioned tasks to get an optimum and most practical solution.



PROPOSAL 1

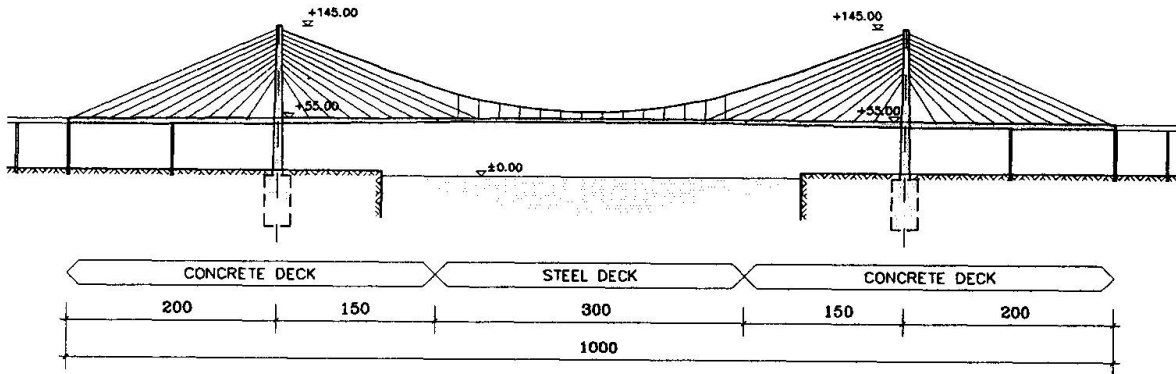

PROPOSAL 2

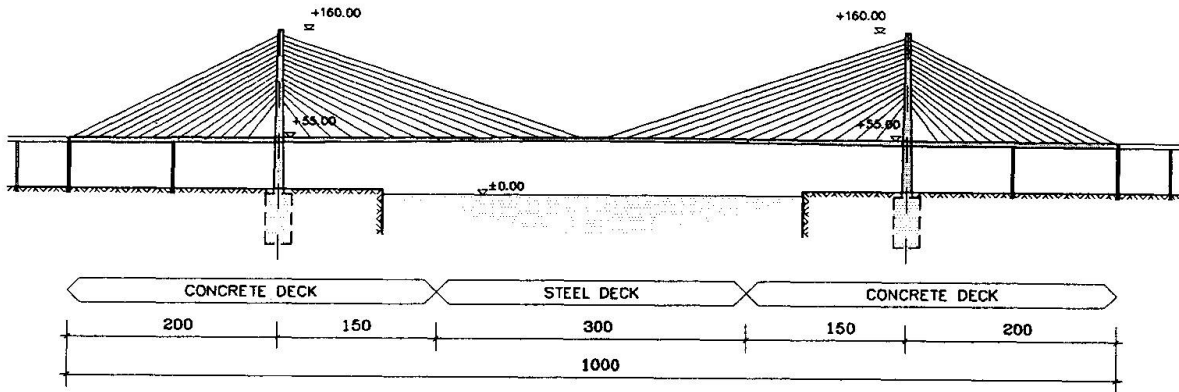

PROPOSAL 3

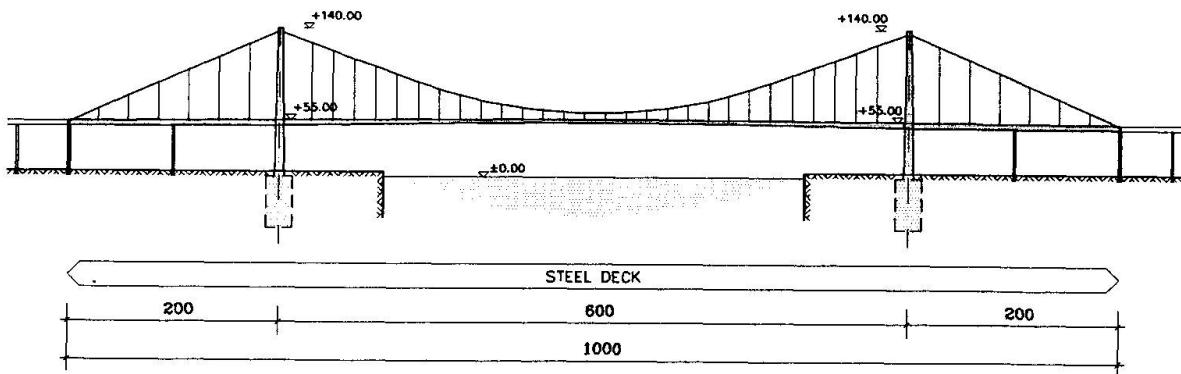

KEELUNG HARBOUR BRIDGE



2. DESIGN CONDITIONS

Besides the tasks named in above chapter the following conditions had to be considered in the study :

2.1 Aerodynamic Facts

It is obvious, that for bridges of this size aerodynamic stability will be most important. The following criteria were considered to minimise the aerodynamic excitations.

- Suitable profile (cross section)
 - Structural stiffness (particularly torsional stiffness)
 - Damping (natural and forced behaviour)
- Particularly to ensure enough resistance against torsion cables are foreseen in 2 planes on the outside of the deck. A suitable profile is chosen in the wind tunnel and dampers will be provided additionally if necessary.

2.2 Seismic Forces

The materials were chosen based on the wish to provide a favourable response to seismic excitations. The stability of concrete structures which is favourable for aerodynamic loads is counterproductive for the seismic load. Anyhow the beam can be designed flexible enough to provide the required displacements for compensation of earth movements (shock waves).

3. CROSS SECTIONS

The side spans shall be able to stand alone and a 5,00m high concrete cross section was chosen, that spans 2x100m and serves also as a counterweight for the unbalanced, self supported structure. The concrete section is continued in the midspan for 150 meters. The height is gradually reduced from 5,00m to 3,50m to reduce the weight as the cable distance is longer.

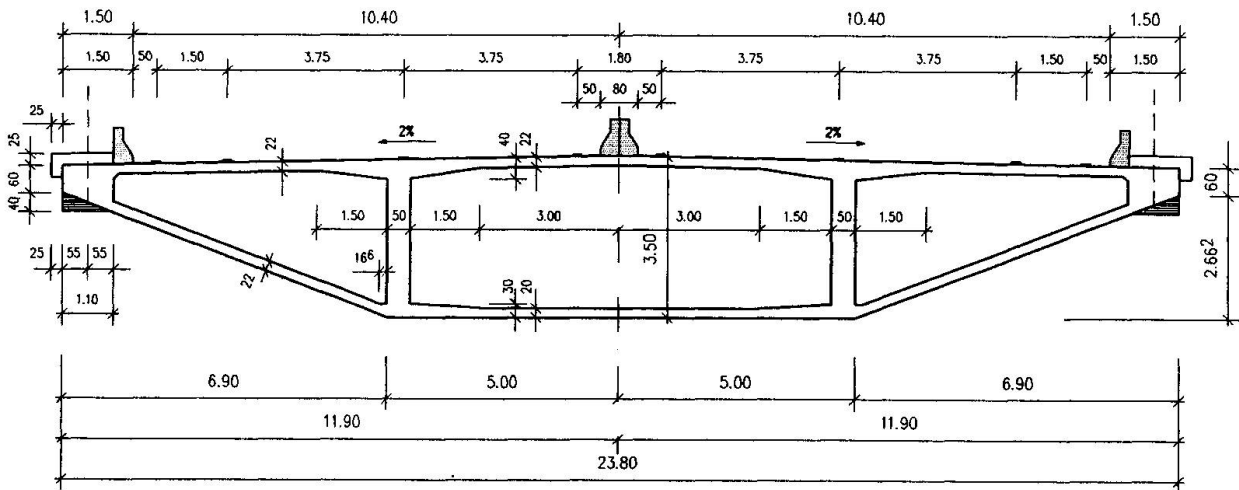

Fig.2 Concrete cross section at midspan

The middle 300m are a composite structure, which is a compromise in saving weight on one hand, but providing an adequate surface and constant conditions on the other hand. The construction of the deck might well be done by precast elements carrying a cast in situ slab. Unfavourable experience has been gained using orthotropic deck slabs in tropical countries.

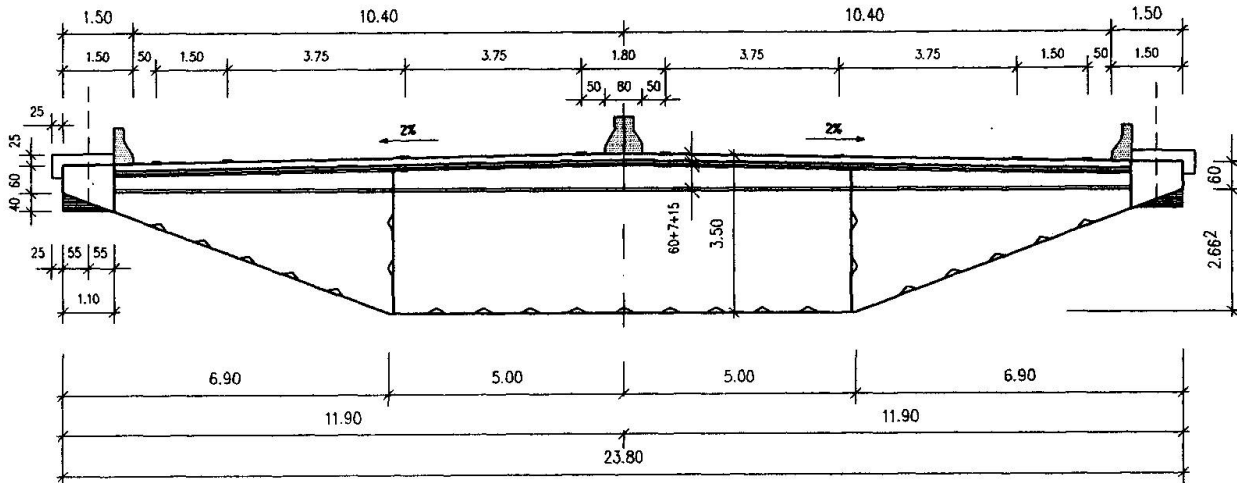

Fig.3 Steel cross section at midspan

4. CABLES

The suspension cable, shown in proposal 1, shall exist of 2x6 single cables, that are combined by a special clamp at the hanger locations. Assembly is done on site similar to stay cables.

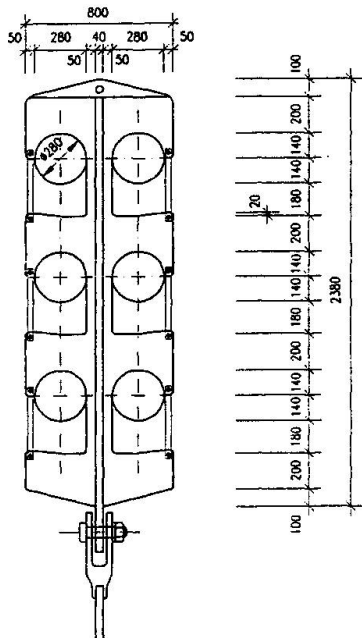

Fig.4 Cable clamp

The cables are anchored in the pylon and the same jacks and mounting equipment can be used for the stay cables and the suspension cables. Another important fact is the possibility to exchange single cables at a later stage, which eliminates one of the weakest characters of suspension bridges.

It seems to be preferable to use cables assembled on deck consisting of 111 PVC coated single strands 0.6" placed in a strong PVC tube, that will be filled with grouting to assure an alkaline atmosphere as a corrosion protection. The monitoring shall be carefully designed and carried out.



5. COST STUDY

The 3 proposals were costed and the variation of costs depending on the span were determined. The result is a recommendation to try the combined system under the present conditions. The cable stayed bridge is more expensive with higher spans, because the required big cables are not yet available and the high pylon is problematic for seismic and wind conditions. For a regular suspension bridge the span is too small. The costs for the spinning of the cables are not increasing linear to the span length. The figure shows the suitable applications of the different systems.

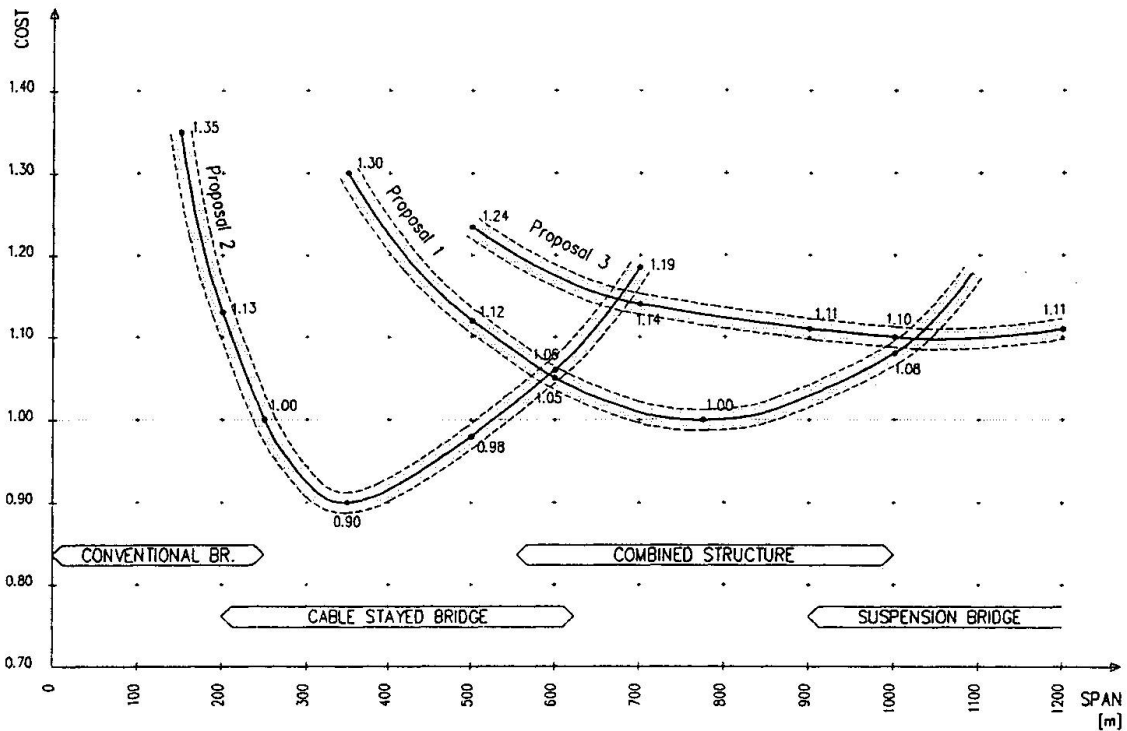

Fig.5 Relative costs of a bridge with span 300-1000m in Taiwan

It is assumed, that the relative differences between the costs of the three methods are greater in case of projects, where the conditions for construction are less limited.

6. CONCLUSION

It is proposed to try a system, that combines the benefits of a cable stayed bridge with that of a suspension bridge, for a structure, that has to span 500-900 meters. Not only the technical solution will be satisfying in respect of practical execution and workability, but also financial benefits can be expected. This type of construction should be feasible under difficult conditions in countries with under developed infrastructure.