

Zeitschrift: IABSE reports = Rapports AIPC = IVBH Berichte
Band: 65 (1992)

Artikel: Columns, slabs and some remarks on execution
Autor: Roik, K. / Bode, H.
DOI: <https://doi.org/10.5169/seals-50052>

Nutzungsbedingungen

Die ETH-Bibliothek ist die Anbieterin der digitalisierten Zeitschriften. Sie besitzt keine Urheberrechte an den Zeitschriften und ist nicht verantwortlich für deren Inhalte. Die Rechte liegen in der Regel bei den Herausgebern beziehungsweise den externen Rechteinhabern. [Siehe Rechtliche Hinweise.](#)

Conditions d'utilisation

L'ETH Library est le fournisseur des revues numérisées. Elle ne détient aucun droit d'auteur sur les revues et n'est pas responsable de leur contenu. En règle générale, les droits sont détenus par les éditeurs ou les détenteurs de droits externes. [Voir Informations légales.](#)

Terms of use

The ETH Library is the provider of the digitised journals. It does not own any copyrights to the journals and is not responsible for their content. The rights usually lie with the publishers or the external rights holders. [See Legal notice.](#)

Download PDF: 02.04.2025

ETH-Bibliothek Zürich, E-Periodica, <https://www.e-periodica.ch>

EC 4: Columns, Slabs and Some Remarks on Execution

EC 4: Colonne, dalles et remarques sur l'exécution

EC 4: Stützen, Platten und einige Bemerkungen über die Ausführung

K. ROIK

Prof. emer. Dr.
Ruhr-University
Bochum, Germany



H. BODE

Prof. Dr.
University Kaiserslautern
Kaiserslautern, Germany



SUMMARY

This paper deals with Eurocode No. 4, Part 1.1, chapters 4.8 and 9, and Annexe E. The design of composite columns assumes complete interaction between steel sections and concrete. This is the basis to establish slenderness ratios and to use buckling curves. In contrast, the design of composite slabs with ductile behaviour takes account of incomplete interaction and partial shear connection. This allows the inclusion of end anchorage facilities as well as additional reinforced bars.

RESUME

Cette contribution traite de l'Eurocode no 4, partie 1.1, chapitres 4.8 et 9 ainsi que l'annexe E. Le dimensionnement des colonnes mixtes suppose une interaction totale entre les sections d'acier et le béton. Ceci constitue la base pour définir des coefficients d'élanement et pour appliquer des courbes de contrainte de flambement. Par contre le dimensionnement des dalles mixtes avec un comportement ductile tient compte d'une interaction partielle et d'une connexion partielle. Ce qui permet de tenir compte des moyens d'ancrage ainsi que des armatures supplémentaires.

ZUSAMMENFASSUNG

Der Beitrag behandelt Eurocode Nr. 4, Teil 1.1, Kapitel 4.8 und 9 sowie Anhang E. Die Bemessung von Verbundstützen legt vollständiges Zusammenwirken zwischen Stahlprofilen und Beton zugrunde. Das liefert die Grundlage, Schlankheitsgrade zu definieren und Knickspannungskurven zu verwenden. Demgegenüber stellt die Bemessung von Verbunddecken mit duktilem Verhalten das unvollständige Zusammenwirken und den Teilverbund in Rechnung. Das ermöglicht es, Endverankerungsmaßnahmen sowie Zusatzberechnungen zu berücksichtigen.



1. COMPOSITE COLUMNS

1.1 General

Composite columns are composite members subjected mainly to compression and bending. The steel section and the uncracked concrete section usually have the same centroid. Typical types of cross sections are shown in Fig. 1:

- concrete encased sections (steel section completely covered by concrete - Fig. 1 a),
- concrete filled sections (concrete completely covered by steel - Fig. 1 d - f),
- partially encased sections (Fig. 1 b - c).

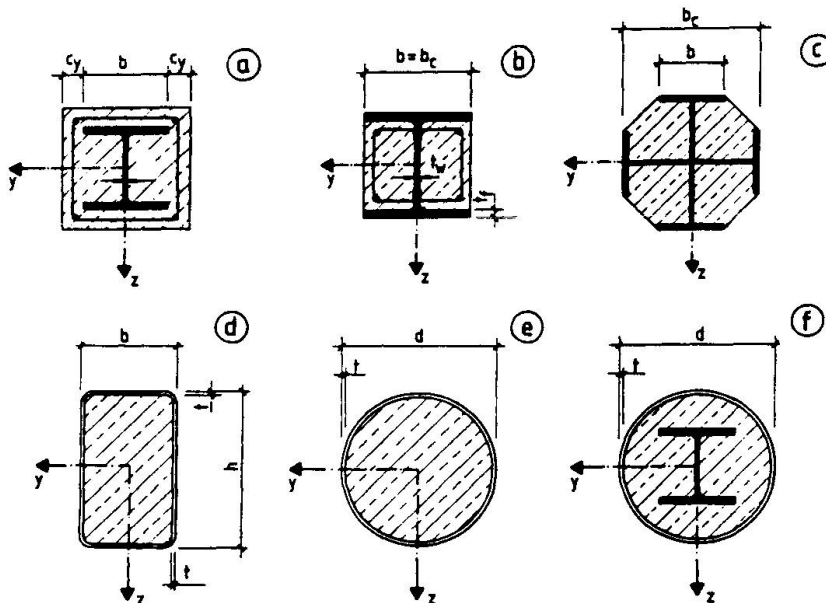

Fig. 1: Typical composite column cross sections

Composite columns have high load carrying capacities, while the outer dimensions are relatively small due to the structural steel sections, which provide a considerable amount of "reinforcement". In addition fire protection measures are not necessary or visible in most cases.

EC 4, clause 4.8 applies to isolated non-sway columns. These may be:

- compression members, which are integral parts of a non-sway frame, but which are isolated for design purposes, or
- real isolated compression members, that satisfy the classification "non-sway".

1.2 Ultimate limit state verifications

A composite column of any cross section, loaded by normal forces and bending moments, shall be checked at the ultimate limit state for:

- resistance to local buckling,
- introduction of loadings,
- resistance to shear (longitudinal and transverse),
- resistance of member (including lateral buckling).

Effects of local buckling may be neglected for steel sections fully encased and for other types of cross sections with limited width over thickness ratios.

Where internal forces and/or moments have to be distributed between the steel and concrete components, it must be ensured that within a specified introduction length, the individual components are loaded according to their capacity. A clearly defined load path shall be established without (excessive) slip at the interface.

The shear resistance shall be provided by bond stresses and friction at the interface or by mechanical shear connection, but again must be such that no significant slip occurs. This leads to the mechanical model of a homogeneous column with full interaction and no slip in the steel concrete interfaces.

To check the resistance of columns, two methods of design are given:

- a general method (4.8.2) including columns with non-symmetrical or non-uniform cross section over the column length,
- an attractive simplified method (4.8.3) for columns of double symmetrical and uniform cross section over the column length, but with a limited scope. Additional application rules for columns of mono-symmetrical section are given in Annex D.

The general method of design takes account of second order effects including imperfections and the non-linear material behaviour. It ensures that instability does not occur, and that the resistance of individual cross sections subjected to longitudinal force and bending is not exceeded.

Comprehensive numerical calculations are necessary to carry out such a non-linear design, which is possible only by means of a computer, and there is a large variety of composite column cross sections. The need to specify simple design methods has led to the simplified method (4.8.3) as an attractive alternative. The scope of it is limited, as it has been based on certain assumptions and adopts the European buckling curves originally established for bare steel columns, as basic design curves for composite columns.

Both design methods assume full composite action up to failure without (excessive) slip at the steel-concrete interface.

1.3 Simplified method of design

1.3.1 Resistance to axial loads

The steel contribution ratio $\delta = A_a \cdot f_{yd}/N_{pl,Rd}$ must satisfy the requirement

$$0.2 < \delta < 0.9 \quad (1)$$

where A_a is the area of the structural steel section,
 f_{yd} is its design yield strength, and
 $N_{pl,Rd}$ is the design plastic resistance to compression, for the composite cross section.

If δ is less than 0.2 the column may be designed according to EC 2; if δ is larger than 0.9, design must be done on the basis of EC 3.

The plastic resistance to compression of an encased cross section should be calculated by adding the plastic resistance of its components:

$$N_{pl,Rd} = A_a \cdot f_y / \gamma_a + A_c \cdot (0.85 \cdot f_{ck} / \gamma_c) + A_s \cdot f_{sk} / \gamma_s \quad (2)$$

Significant economy can be achieved in designing stocky concrete-filled circular steel columns by taking account of triaxial effects due to the confinement of steel tube:

$$N_{pl,Rd} = A_a \cdot \eta_2 \cdot f_y / \gamma_a + A_c (f_{ck} / \gamma_c) [1 + \eta_1 \frac{t}{d} \cdot \frac{f_y}{f_{ck}}] + A_s \cdot f_{sk} / \gamma_s \quad (3)$$

where $0 < \eta_1 < 4.90$ and $1.00 \geq \eta_2 \geq 0.75$,
 A_c and A_s are the cross-sectional areas of the concrete and the reinforcement, and
 f_{ck} and f_{sk} are their characteristic strengths, respectively.
 γ_a , γ_c , and γ_s are the partial safety factors γ_M for structural steel, concrete, and reinforcement, respectively; and dimensions t and d are defined in Fig. 1.



These triaxial effects diminish with increasing load eccentricity or column slenderness $\bar{\lambda}$. If the eccentricity e exceeds the value $d/10$, or the relative slenderness $\bar{\lambda}$ exceeds the value 0.5, then the confinement is no longer effective, yielding

$$\eta_1 = 0 \text{ and } \eta_2 = 1.0.$$

A slender composite column has sufficient resistance if for both axes

$$N_{Sd} \leq \chi \cdot N_{pl,Rd} \quad (4)$$

where the reduction coefficient χ depends on the relevant slenderness $\bar{\lambda}$ and the appropriate buckling curve in Eurocode 3: Part 1.1:

- curve a for concrete filled hollow profiles,
- curve b for partially and fully encased profiles with bending about the strong axis of the steel section,
- curve c for encased sections with bending about the weak axis.

Extra imperfections within the column length need not be considered as they are taken into account in this determination of column resistance.

The non-dimensional slenderness is given by

$$\bar{\lambda} = \sqrt{N_{pl,R}/N_{cr}} \leq 2.0, \quad (5)$$

where $N_{pl,R}$ is the value of $N_{pl,Rd}$ when the γ_M -factors are taken as 1.0, and N_{cr} is the elastic critical load calculated from

$$N_{cr} = \pi^2(EI)_e/l^2. \quad (6)$$

where l is the buckling length.

$(EI)_e$ denotes an effective flexural stiffness of cross section, where a term $0.8 \cdot E_{cd} \cdot I_c$ is used for the concrete part. Particularly this term has been calibrated in such a manner, that ultimate load test results are in good agreement with calculated column resistances.

Additional application rules are given to reduce the effective elastic modulus of concrete in order to account for long-term loading.

1.3.2 Resistance to combined compression and uniaxial bending

The resistance of cross sections in combined compression and bending can be determined from the interaction diagram, Fig. 2. The curve can be represented by the further simplified

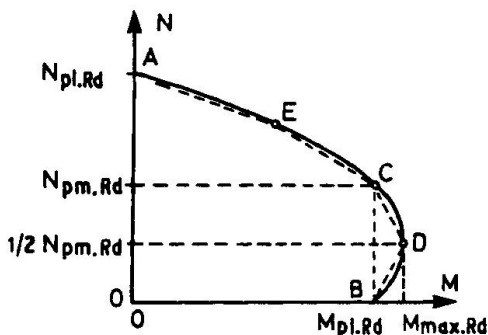

Fig. 2: Interaction curve, cross section

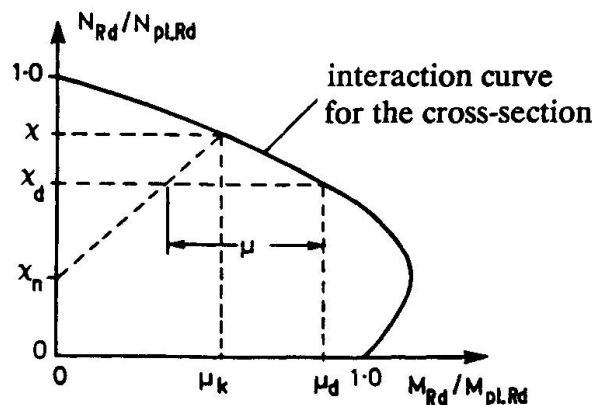

Fig. 3: Design procedure for columns

polygonal diagram (dashed line). Points A to D may be calculated assuming rectangular stress blocks, disregarding particular strain limitations. More information for the simple calculation of points A to D is given in Annex C.

The moment of resistance at point C is obviously identical to that at point B: $M_C = M_{pl,Rd}$. It can be shown that the axial force $N_{pm,Rd}$ equals the compressive resistance of the whole area of concrete, which can be calculated easily.

This interaction diagram for the resistance of cross sections may be used to check the column resistance too, see fig. 3.

First the resistance of the column under axial compression has to be determined as mentioned before. This resistance is defined by the reduction factor χ , which accounts for the influence of imperfections and slenderness. According to this factor χ the μ_k -value for the bending moment, which represents the moment due to imperfection, can be read off the interaction curve (or polygon). The influence of this imperfection moment is assumed to decrease linearly to the value χ_n . For the related design normal force $\chi_d = N_{Sd}/N_{pl,Rd}$ the moment factor μ represents the remaining moment resistance. It must then be shown that

$$M_{Sd} \leq 0.9 \cdot \mu \cdot M_{pl,Rd}, \quad (7)$$

where M_{Sd} is the maximum design bending moment within the column length, calculated including second order effects if necessary (see below).

The value χ_n accounts for the fact that imperfections and bending moments do not always act together unfavourably. For columns with end moments, χ_n may be calculated from

$$\chi_n = \chi \cdot \frac{1-r}{4}, \text{ but } \chi_n \leq \chi_d \quad (8)$$

where r = ratio of end moments ($-1 \leq r \leq +1$)

Columns generally shall be checked for second order effects. This influence may be neglected in case of isolated non-sway columns as long as:

- the normal force N_{Sd} is smaller than 10 % of the critical load N_{cr} , or
- the relative slenderness $\bar{\lambda}$ does not exceed the value $\lambda_{crit} = 0.2(2-r)$.

The length μ in Fig. 3 may be calculated from the equation

$$\mu = \mu_d - \mu_k (\chi_d - \chi_n) / (\chi - \chi_n). \quad (9)$$

This equation can be further simplified by setting $\chi_n = 0$.

This simplified design method is based on a lot of international research reports on composite columns, including work done by Janss, Dowling, Johnson, Roik and their teams.

The background paper /2/ contains comparison calculations with 208 well documented tests. These calculations yielded an average variation coefficient $V_{R_t} = 0.07$ and statistically determined design values $r_d = 0.665$ related to mean values. Compared with the simplified design method of EC 4 the ratio lies between 0.97 and 1.25, with a mean value of 1.08 on the safe side.

1.3.3 Combined compression and biaxial bending

Due to the different slenderness, bending moments, and resistances of bending for two axes, in many cases a check for the biaxial behaviour is necessary. EC 4 contains a similar design method for this case, using values μ_y and μ_z for the two axes of bending.



2. EXECUTION

Minimum standards of workmanship required during execution are specified in chapter 9 to ensure that the design assumptions are satisfied and hence that the intended level of safety can be attained. But this chapter, which includes reference to Eurocode 2 and 3, is neither intended, nor extensive enough, for a contract document.

Particularly the following topics are mentioned:

- Stability of the steelwork during erection,
- Early and sufficient fixing of profiled steel sheeting,
- Speed and sequence of erection, propped and unpropped construction,
- Welding of headed studs through metal decking to the supporting beam; welding conditions; checks and visual inspection,
- Use of friction grip bolting, anchors, hoops, and block connectors including corrosion protection in the interface.

3. ALTERNATIVE DESIGN METHOD FOR COMPOSITE SLABS

3.1 General

The partial shear connection design method as given in Annex E should be used for composite slabs with ductile behaviour only. This alternative to the $m+k$ -method may be used to account also for contributions from additional end anchorage means or longitudinal reinforcing bars.

Figure 4 illustrates the ductile behaviour of a particular composite slab. Presented are test loading and end slip plotted against the midspan deflection. In this special test a metal decking with re-entrant shape and additional embossments has been used. Ductility means that significant slip occurs at the steel-concrete interface, before the maximum

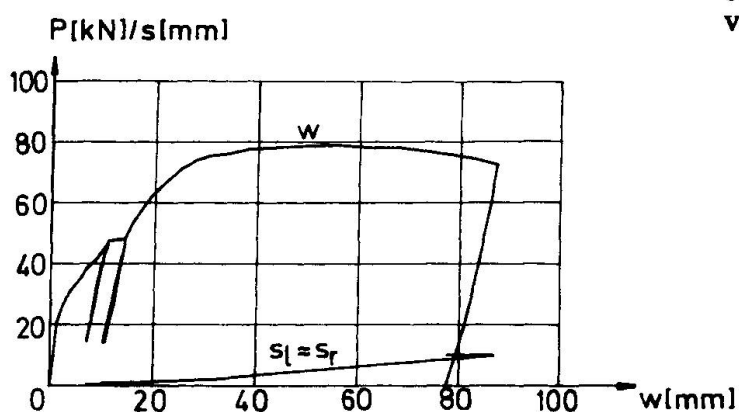
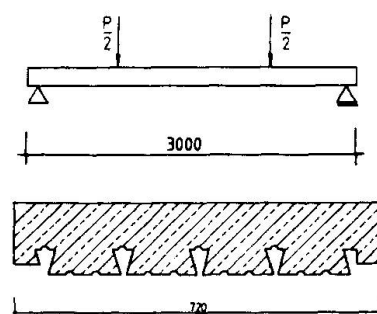

Fig. 4: Test results; particular composite slab with ductile behaviour



test load has been reached. In designing such composite slabs it may be assumed - and should be verified by tests - that sufficient slip can occur for moments of resistance at critical cross sections to be calculated from plastic theory, based on partial shear, and therefore with a second plastic neutral axis in the profiled sheeting. This design method leads to a unified design of composite beams and slabs with ductile shear connection.

3.2 Determination of design shear strength

Slab tests (see EC 4, chapter 10.3) only are to be carried out in order to determine the design value of the horizontal shear strength $\tau_{u,Rd}$. This is the only parameter which has to be evaluated from tests.

Fig. 5 shows a particular partial connection diagram for the test evaluation, which incorporates the actual geometry with measured dimensions and strengths of the considered test specimen.

At the end of a test, at failure, a bending moment M_{test} is acting on the critical cross section under the point load. The degree of shear connection η_{test} , which can be read off the diagram, yields the horizontal shear strength between the end of the metal decking and the load position:

$$\tau_u = \frac{\eta_{test} \cdot N_{cf}}{b(L_s + L_o)} = \frac{N_c}{b(L_s + L_o)} \quad (10)$$

where N_c is the compressive force in the concrete slab,
 N_{cf} is the value of N_c for full shear connection,
 b is the breadth of the concrete slab, and
 L_s and L_o are defined in Fig. 5.

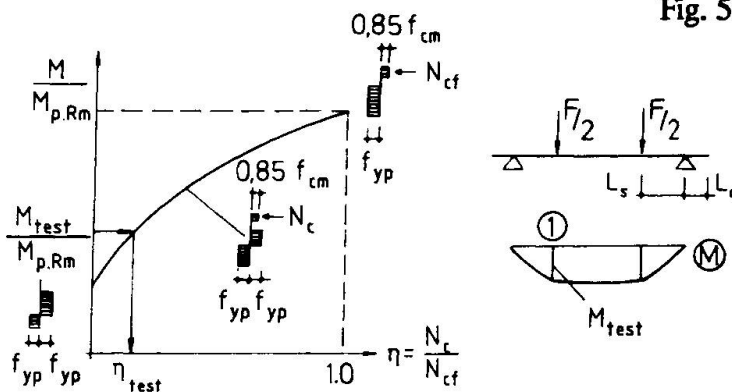

Fig. 5: Determination of the degree of shear connection from M_{test}

The force N_c is limited due to the incomplete shear connection, and thus it reduces the bending resistance. At the end of each test series the derived τ_u -values provide the basis to determine the characteristic value $\tau_{u,Rk}$ as the minimum value from all tests of this series minus 10%. The design shear strength $\tau_{u,Rd}$ equals this characteristic value, divided by $\gamma_v = 1.25$.

3.3 Verification at the ultimate limit state

The partial connection diagram - now calculated with design values - represents the boundary curve for the bending moment resistance M_{Rd} of the slab in Fig. 6:

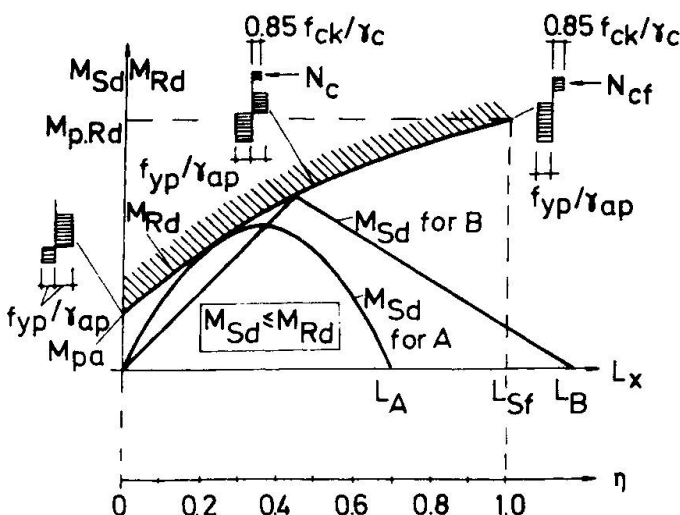

Fig. 6: Verification procedure



The compression force N_c at L_x can be determined from $N_c = b \cdot L_x \cdot \tau_{u,Rd}$ (11)

while the length L_{sf} is given by

$$L_{sf} = N_{cf} / (b \cdot \tau_{u,Rd}) \quad (12)$$

and denotes the clear distinction between full and partial shear connection. At any cross section the design bending moment M_{Sd} due to loading and span should not exceed the design resistance M_{Rd} .

In case of additional end anchorage, account may be taken by adding the end anchorage design strength V_{ld} as follows:

$$N_c = b \cdot L_x \cdot \tau_{u,Rd} + V_{ld} \quad (13)$$

This results in a shift of the basic partial interaction diagram in the L_x -direction over a distance of $-V_{ld} / (b \cdot \tau_{u,Rd})$. It should be noted, however, that end anchorage does not only increase the strength, but also enhances the total slab behaviour up to failure, particularly with respect to ductility. As an example Fig. 7 shows the different behaviour in composite slab tests, where a special trapezoidal sheeting has been used without and with end anchorage (3 and 5 throughwelded studs), respectively.

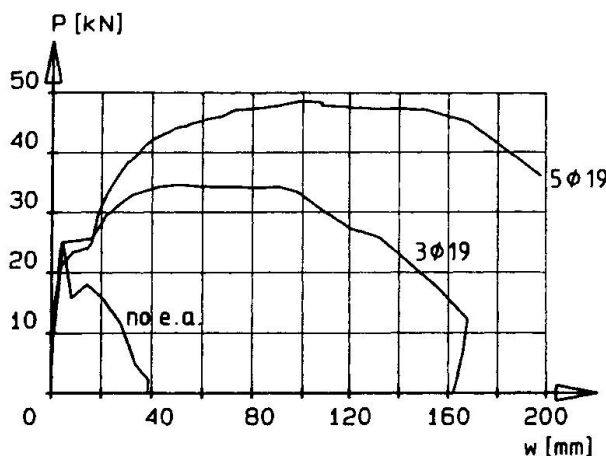
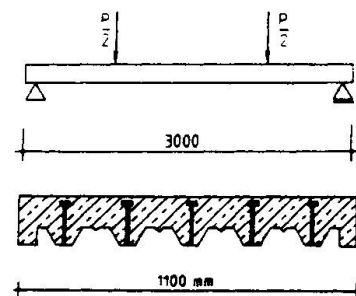

Fig. 7.: Enhancement of behaviour and load carrying capacity due to end anchorage



If additional bottom reinforcement shall be taken into account, the verification should follow the same procedure. But the partial interaction diagram should be modified by adding the bending strength of the reinforced concrete part, which leads to a larger compression force N_c simultaneously:

$$N_c = b \cdot L_x \cdot \tau_{u,Rd} + N_{as}, \quad (14)$$

where N_{as} is the design strength of fully anchored bottom reinforcement.

The validity of the partial connection method for composite slabs with end anchorage or/and additional reinforcement should be proved by further tests.

From the today's point of view the following methods of end anchorage are of main interest:

- through welded headed studs
- bent rib anchors in case of metal decking with re-entrant shape.

3.4 Conclusion

It is likely that other methods of anchorage and new profiled sheeting will enter the market. Annex E will not prevent further developments, but will actually give some helpful support. Additionally, Annex E pushes the development of new products to slabs with ductile shear connection behaviour, mainly depending on the type of profiled sheeting used.