

**Zeitschrift:** IABSE reports = Rapports AIPC = IVBH Berichte  
**Band:** 79 (1998)

**Artikel:** Technical advances in the Honshu-Shikoku bridges  
**Autor:** Kashima, Satoshi  
**DOI:** <https://doi.org/10.5169/seals-59828>

### **Nutzungsbedingungen**

Die ETH-Bibliothek ist die Anbieterin der digitalisierten Zeitschriften. Sie besitzt keine Urheberrechte an den Zeitschriften und ist nicht verantwortlich für deren Inhalte. Die Rechte liegen in der Regel bei den Herausgebern beziehungsweise den externen Rechteinhabern. [Siehe Rechtliche Hinweise.](#)

### **Conditions d'utilisation**

L'ETH Library est le fournisseur des revues numérisées. Elle ne détient aucun droit d'auteur sur les revues et n'est pas responsable de leur contenu. En règle générale, les droits sont détenus par les éditeurs ou les détenteurs de droits externes. [Voir Informations légales.](#)

### **Terms of use**

The ETH Library is the provider of the digitised journals. It does not own any copyrights to the journals and is not responsible for their content. The rights usually lie with the publishers or the external rights holders. [See Legal notice.](#)

**Download PDF:** 02.04.2025

**ETH-Bibliothek Zürich, E-Periodica, <https://www.e-periodica.ch>**

## Technical Advances in the Honshu-Shikoku Bridges

**Satoshi KASHIMA**  
Gen. Mgr, First Constr. Bureau  
Honshu Shikoku Bridge Authority  
Kobe, Japan



Satoshi Kashima, born 1944, received his M.S. degree from Tokyo Metropolitan University in 1968 and Ph.D. from University of Texas in 1973.

### Summary

The Honshu-Shikoku Bridge Project links Honshu and Shikoku by three routes of large scale bridges over the Seto Inland Sea. After construction had first commenced in 1975, Kojima-Sakaide route for highway and railway was put into service in 1988, the Kobe-Naruto route which contains the largest suspension bridge as ever, has completed in 1998, and Onomich-Imabari route, which includes a superlong cable-stayed bridge, will open in the spring of 1999.

This paper describes the technical advancement in large scale bridge construction at Honshu-Shikoku Bridges, from the outset of construction when there were less experiences to the completion of the world's longest suspension bridge, whilst increasingly enlarging the construction scale overcoming various technical problems.

### 1. Introduction

The land of Japan is mainly composed of four islands; Honshu, Hokkaido, Kyushu and Shikoku. The idea of bridging Shikoku with Honshu was first conceived about a hundred years ago. The first technical surveys had been around forty years ago by the Ministry of Construction and other agencies. And in 1970, the Honshu-Shikoku Bridge Authority was founded as the organization to execute construction and administrate the highway and railway linking Honshu and Shikoku.

As shown in Fig. 1, Honshu-Shikoku Bridges consist of three routes; Kobe-Naruto Route, Kojima-Sakaide Route and Onomich-Imabari Route.

The Kobe-Naruto Route has two long-span suspension bridges; Ohnaruto Bridge completed in 1985, and Akashi Kaikyo Bridge, the longest suspension bridge ever between Honshu and Awaji Island, completed in 1998. The Kojima-Sakaide Route for highway and railway, which was put into service in 1988, connects Honshu and Shikoku by three suspension bridges, two cable-stayed bridges and other truss bridges via five small islands. Onomich-Imabari Route has ten bridges via nine islands. Six bridges have already been in service and the remaining four will be completed in the spring of 1999.

The total amount of construction cost will be about 3,400 billion yen.

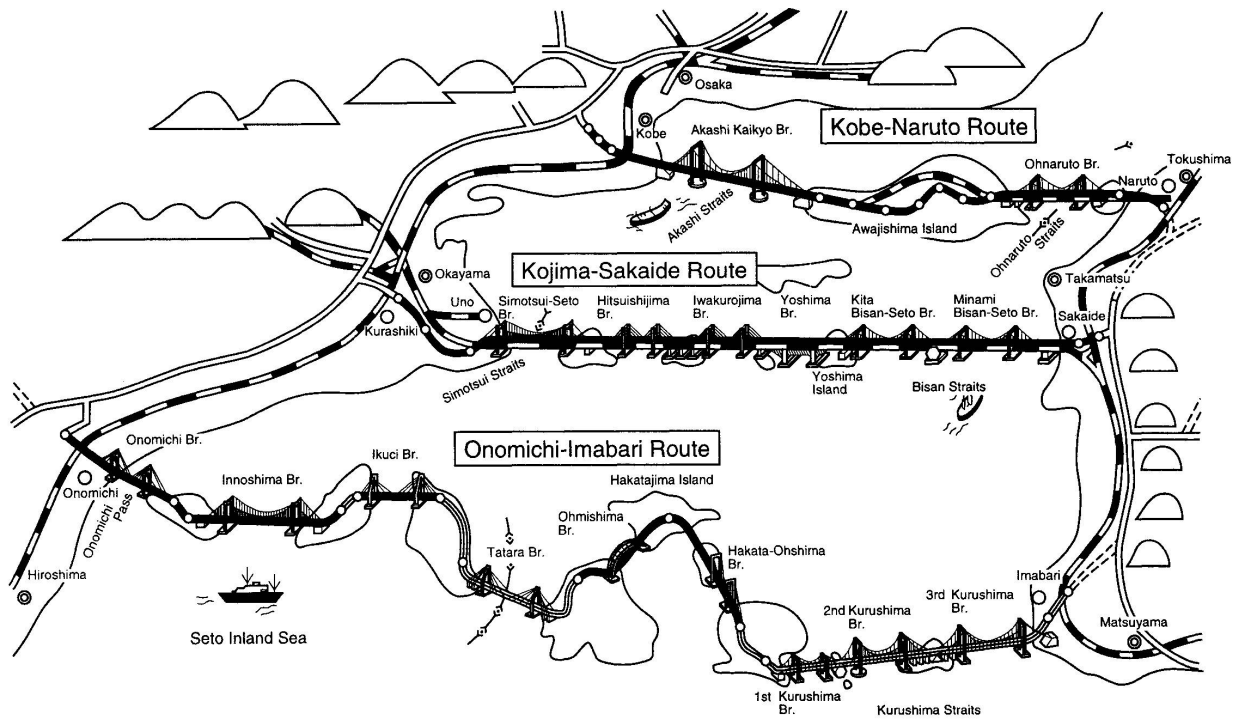

Fig. 1 Bird's-Eye View of Honshu-Shikoku Bridges



## 2. Advancement of Long Span Bridges in Japan

Fig. 2 shows the suspension bridges and their center span in the world. Wakato Bridge with its center span of 369 m was the first long span suspension bridge in Japan, which was based upon the construction technology developed in the US, partially arranged with traditional domestic bridging bridge construction techniques. Then came Kanmon Bridge (center span; 712 m) in 1973, which was as twice the length of center span as Wakato Bridge. Since ten years after Kanmon Bridge, the gradual implementation of Honshu-Shikoku Bridge projects has produced Innoshima Bridge (center span; 770 m) in 1983, Ohnaruto Bridge (876 m) in 1985, and bridges of Kojima-Sakaide Route in 1988, as Shimotsui Seto (940 m), Kita-Bisan Seto (990 m), Minami-Bisan Seto (1,100 m). About fifty years later, Japan had caught up with the Golden Gate Bridge (center span over 1,000 m) completed in 1937 in terms span length, by the appearance of the Minami-Bisan Seto Bridge. And with the extension of those technologies whilst acquired, accomplished the superlong Akashi Kaikyo Bridge (Fig. 3) in April, 1998.

Fig. 4 shows the history of cable stayed bridge. Its construction technology has also greatly progressed during this thirty years. In the spring of 1999, the Tatara Bridge, the largest cable-stayed bridge as ever, is scheduled to be completed (see Fig. 5).

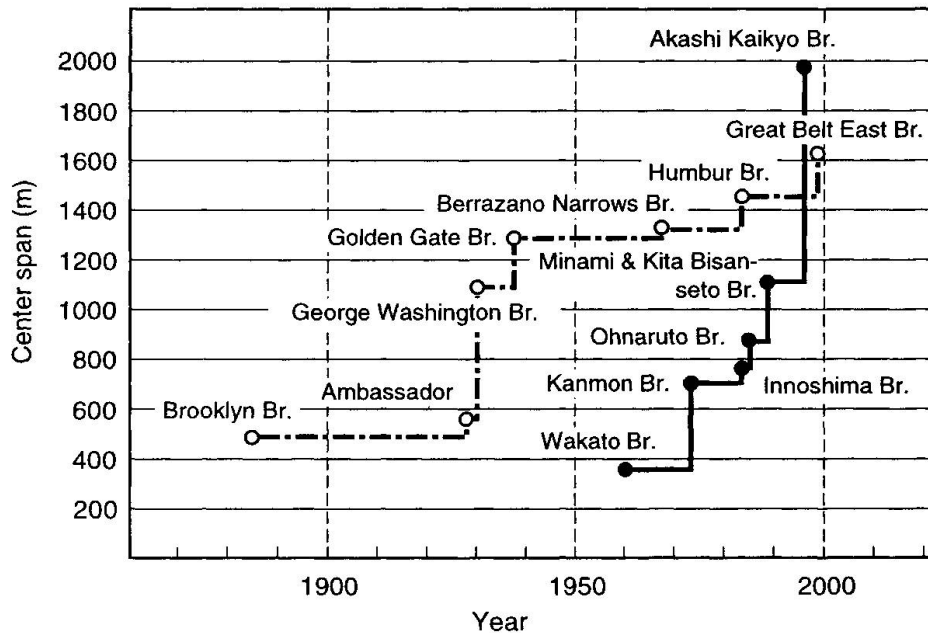

Fig. 2 History of Span Enlargement of Suspension Bridge

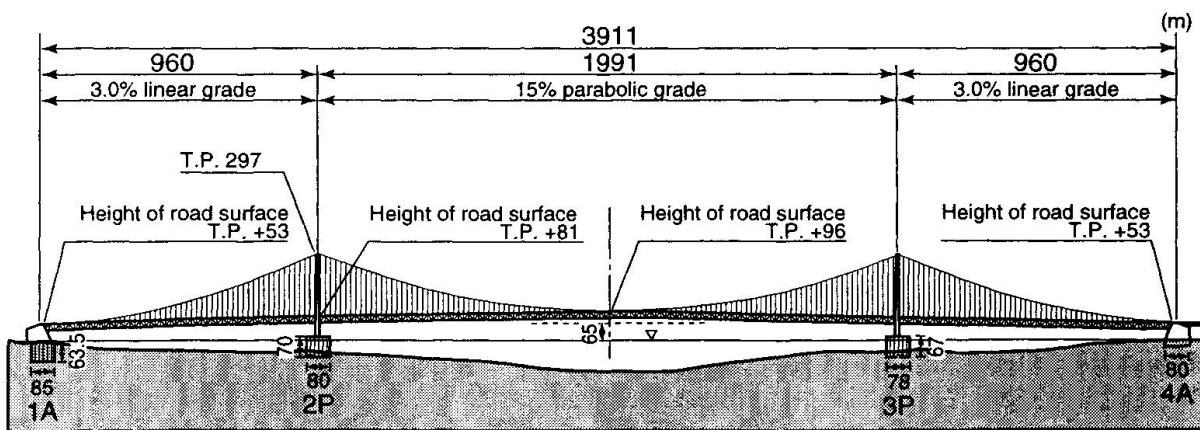

Fig. 3 General View of the Akashi Kaikyo Bridge

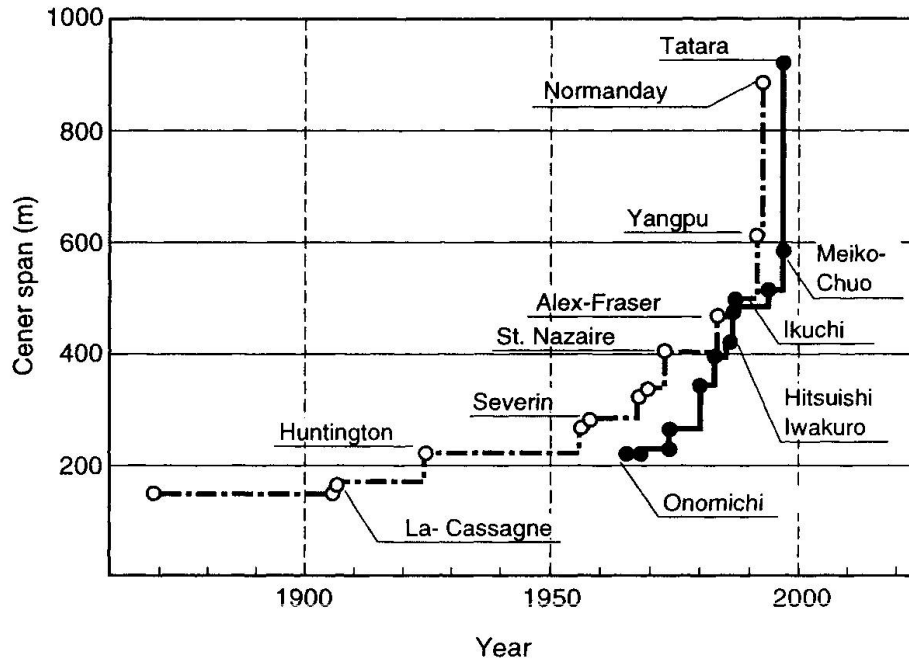

Fig. 4 History of Span Enlargement of Cable Stayed Bridge

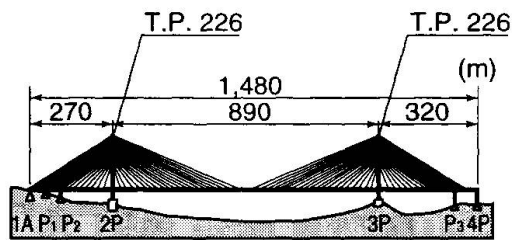

Fig. 5 General View of the Tatara Bridge

### 3. Design of Substructures

The foundations of Honshu-Shikoku Bridge are generally bedded on granite layer. As to the foundations of Akashi Kaikyo Bridge except for that of Awaji side, however, the granite bed is so deep as shown in geo-section map (Fig. 6), it was impractical to form on granite bed, eventually had to construct on the Kobe layer which is of soft rock formed in relatively later age, and on the relatively-tight sand conglomerate of Akashi layer. Since the supporting bed was relatively soft and the conventional seismic design method based on firm and solid earth was not applicable, another concept for seismic design had to be established.

For the foundations of the Akashi Kaikyo Bridge so enormous in scale, the concept of "dynamic mutual action" was implemented for its seismic design. This concept is divided into two categories; one that of "effective seismic motion", in which quake energy input to foundation will be damped and reduced by the footing itself, and another "dynamic restoration force theory" based on the compound action between the earth and footing, by assuming the earth as a vibration entity.

On January 17, 1995, a big earthquake had occurred just centered around the Akashi Strait. Later investigation showed that the crust upheaval widened the Strait and stretched the bridge length by

1.1 m without any damage to the bridge main structure, thus eventually verified the seismic reliability. Also, to seize the characteristics of the Akashi geo-layer which contains conglomerate of 10 cm in dia., it was essential to acquire stable samples of at least 30 cm in dia.. For this reason, the triple-tube sampling machine with large caliber of 360 cm was implemented.

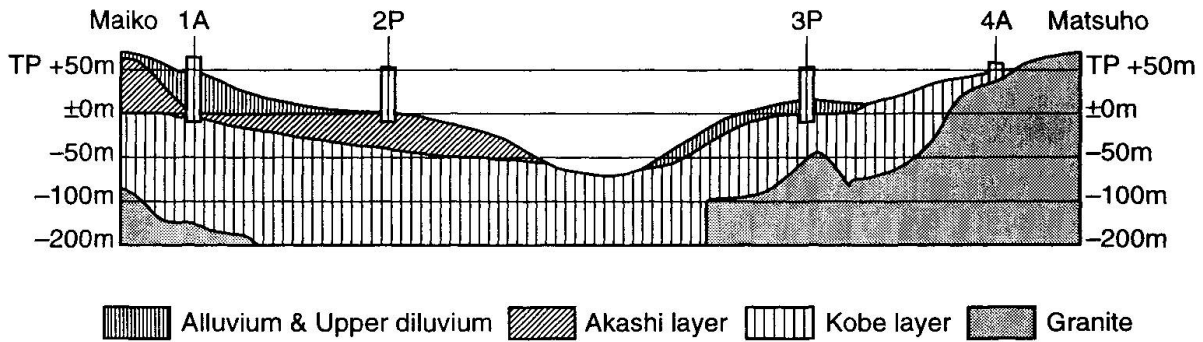

Fig. 6 Geological Section of the Akashi Strait

#### 4. Construction of Substructures

Fig. 7 shows the resultant history of underwater substructures in Japan. The first stage of foundations about twenty years ago were erected in the depth of approximately 20 m. Minami-bisan Seto Bridge in the meantime, its water depth was 36 m. In 1991, tower foundations of the Akashi Kaikyo Bridge were constructed in the water as deep as 45 m.

The first full-fledged underwater foundation started in Kojima-Sakaide Route which includes the Minami-Bisan Seto Bride. Its construction method is as followings. First, the seabed was dredged into supporting bed by a huge grab-bucket excavator, then a prefabricated steel caisson was towed to the site by a fleet of tugboats and installed down on the supporting bed in the water as shown in Fig. 8. Finally, underwater concrete was cast into the caisson to form a foundation. In the case of Akashi Kaikyo Bridge, although the basic construction process was the same, a lot of technical innovations had to be done. The comparison of tower foundations of the Minami-Bisan Seto Bridge and the Akashi Kaikyo Bridge is shown in Table 1.

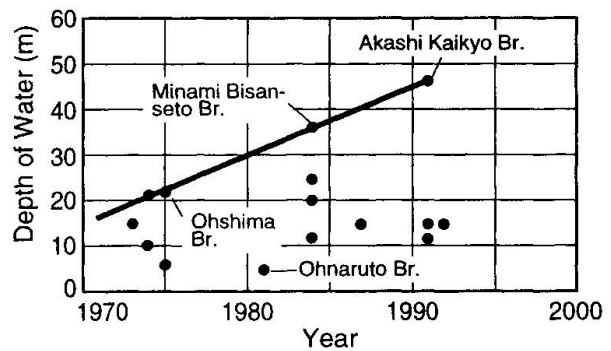

Fig. 7 Development of Underwater Foundation in Japan

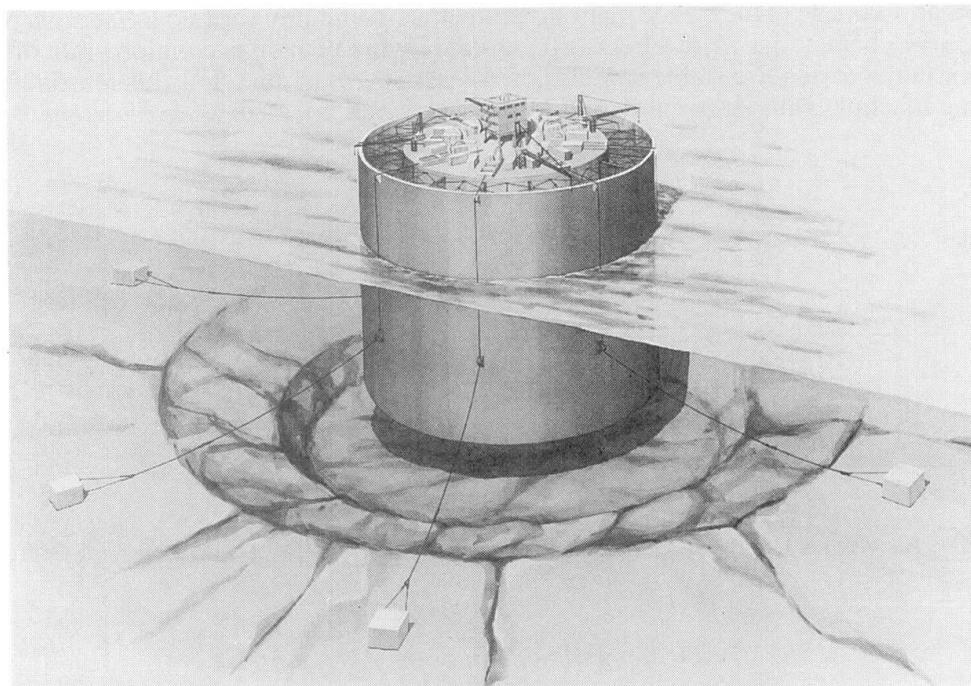

Fig. 8 Installation of Prefabricated Steel Caisson on Excavated Seabed

Table 1 Comparison of Tower Foundation

	Minami Bisan-Seto	Akashi Kaikyo
Depth of water (m)	36	45
Tidal current (m/sec)	1.7	3.5
Geological condition	Granite	Akashi Layer (sand gravel)
Depth of supporting bed (m)	50	60
Volume under water level (m <sup>3</sup> )	112	301

The Akashi Strait, compared to the case of Minami-Bisan Seto, with its rapid tidal current and sand gravel of the seabed, is liable to scouring. The intricate vortex and acceleration flow around the caisson generate strong and complicated shearing/lifting force around the structure, thus causes scouring as shown in Fig. 9. Among a lot of preventive measures against scouring of maritime structures, riprap showed to be most effective in terms of function, cost and maintenance, in a strong tidal current like in the Akashi Strait. According to the scale model experiment shown in Photo 1, rubble of 1 metric ton was proved to be stable enough against a tidal velocity of 4 m/sec. Therefore, 3 m thick riprap layer was formed around the caisson in the range of three times of caisson diameter. The periodical depth survey has showed that the condition is stable at large without any major evidence of scouring.

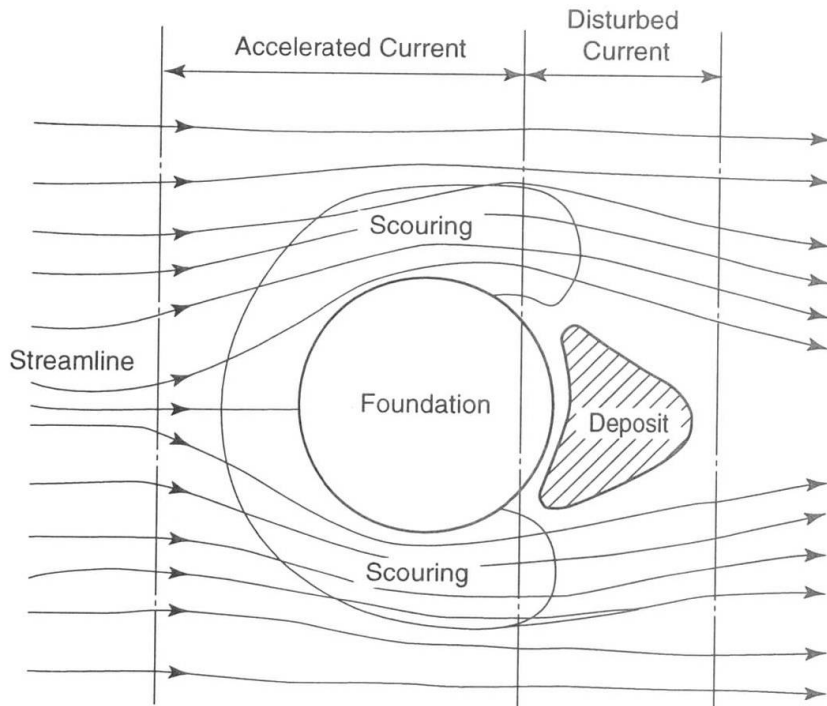

Fig. 9 Concept of Flow around Foundation

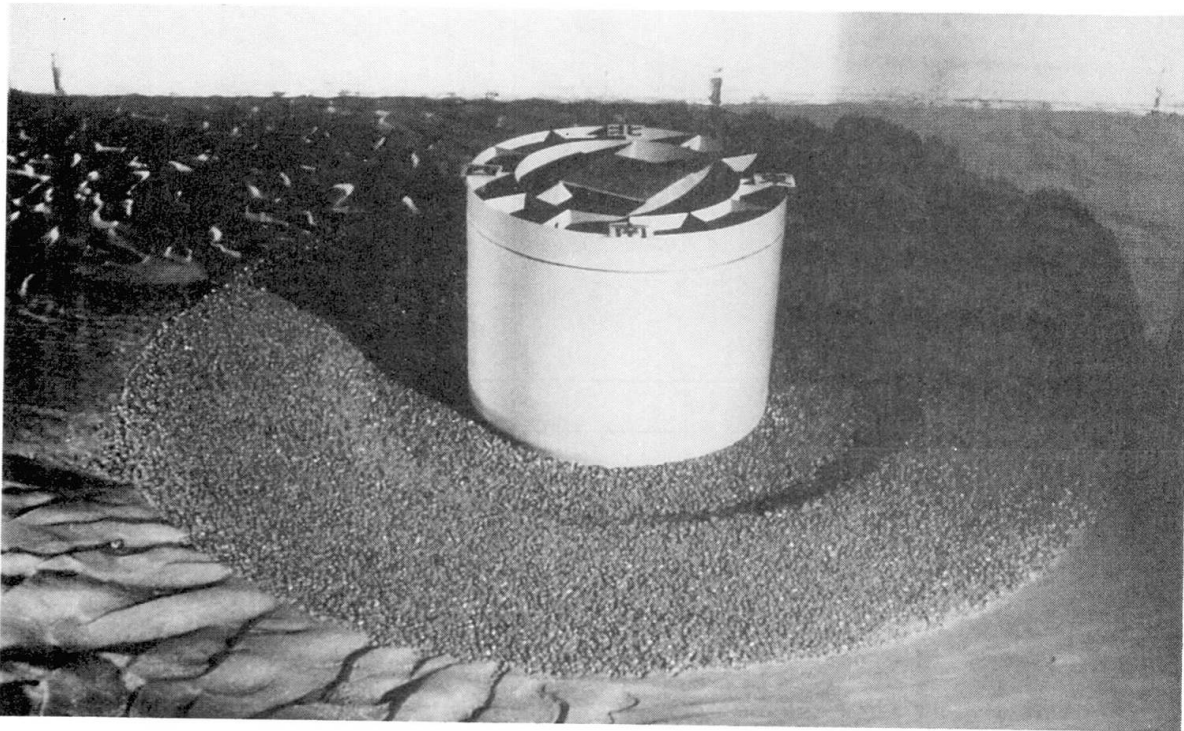

Photo 1 Scouring Test with Protection

Once a caisson was installed on the seabed, concrete was cast to fill the caisson. The foundations in the Kojima-Sakaide Route were constructed by the pre-packed concrete method, in which considerably larger size gravels (7 — 15 cm dia.) were poured in at first, then mortar was deposited to fill the gap among the gravels. This method required delicate precaution measures such as prevention of powdering effects of gravels in the process of throwing in, arrangement of stone size





to maintain mortar fluidity. It also requested a large scale plant for catering sized gravel. In the Akashi Kaikyo Bridge on the otherhand, since the preparation of huge base plant for that purpose was practically impossible, antiwashout underwater concrete method was devised. Antiwashout admixture itself had been already developed in Germany. At that time in Japan, though, there was no experience of it in large scale structures, that a wide range of experiments from basic to large scale operational ones were required. The essential characteristics for underwater concrete are; a higher desegregation, lasting fluidity and heat crack resistivity. For this reason, low heat generative cement mixed with desegregating admixture and superplasticizer was used. Photo 2 shows the slump test, and Fig. 10 shows the resultant effects between flow distance and concrete strength. The arrangement of casting pipes was decided according to these data.

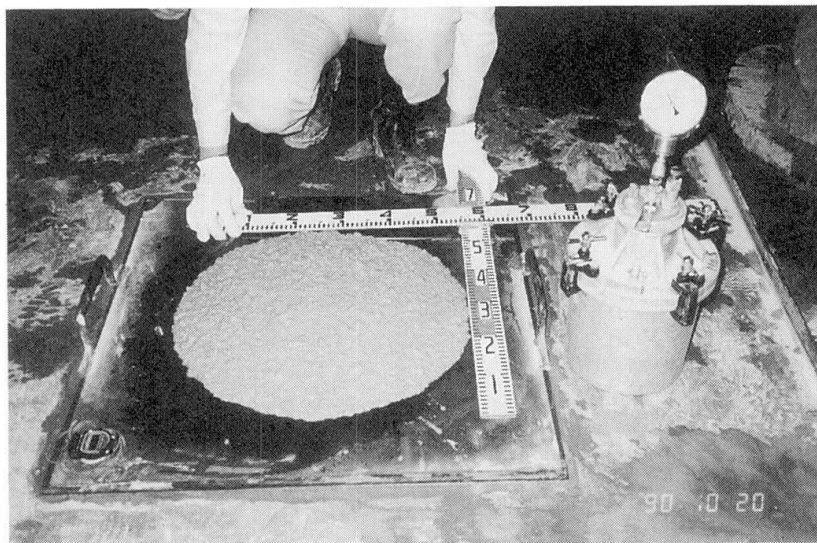

Photo 2 Slump Test of Antiwashout Underwater Concrete

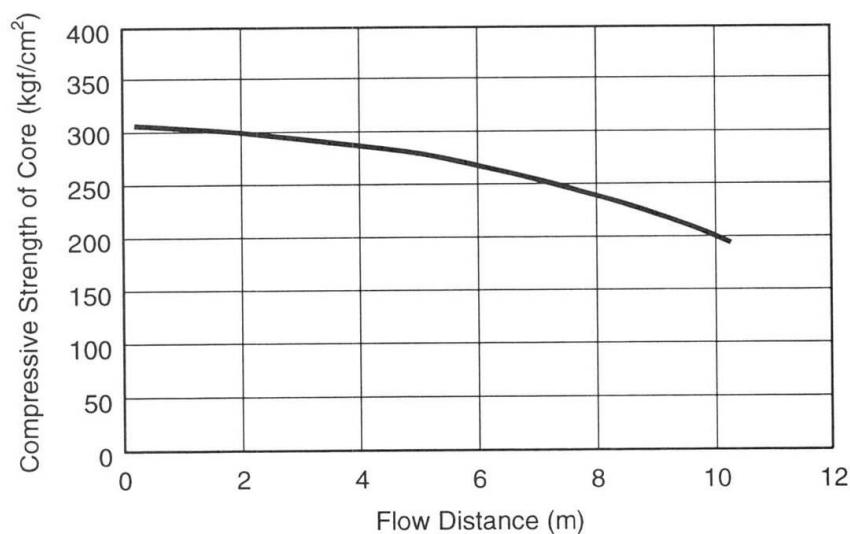

Fig. 10 Relation Between Flow Distance and Core Strength of Antiwashout Underwater Concrete

## 5. Design of Superstructure

The stiffening girder of the Akashi Kaikyo Bridge is so thin as compared to the scale of its supporting span, that it is susceptible to deform and generate self-excited oscillation by wind because of its low natural frequency. As for aero-dynamic stability design, “non dimensional wind velocity” was implemented to show the index against wind stability. As shown in Fig. 11, the longer becomes the center span, the larger increases the index, thus requires higher wind proof stability. The wind proof stability was also examined by the wind tunnel experiment which used 40 m long, 3 dimensional whole-bridge scale model (scale: 1/100), in addition to the conventional independent girder model (Photo 3).

Main cable of a suspension bridge principally support the dead load and live load of the bridge.

As shown in Fig. 12, the center span becomes longer, the greater increases the rate of dead load.

In the case of Akashi Kaikyo Bridge, some 90 % of its main cable section bears the dead load. The reduction of dead load directly results in the curtailment of steel volume as a whole and suppression of construction cost. As in Fig. 13, a pre-study on the Akashi Kaikyo Bridge showed that the conventional cable material of 160 kgf/mm<sup>2</sup> would require double lines of cable on each side, totally 4 lines of main cable. This would complicate the structure as well as construction, therefore cable material of higher strength had to be developed. With use of 180 kgf/mm<sup>2</sup> high strength wire as well as re-examination of its safety factor, the main cable of the Akashi Kaikyo Bridge resulted in the single line of  $\phi 1.1$  m on each side. Fig. 14 shows the history of cable strength in suspension bridges.

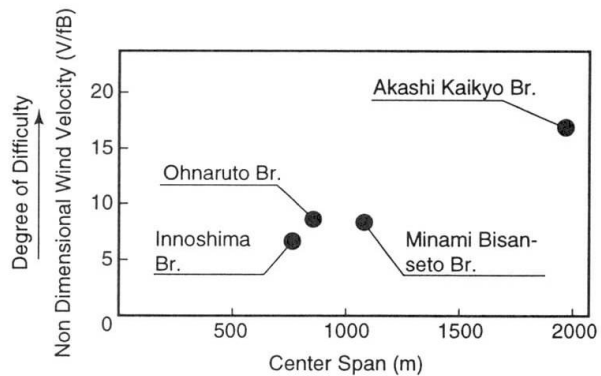

Fig. 11 Degree of Difficulty to Keep Aerodynamic Stability

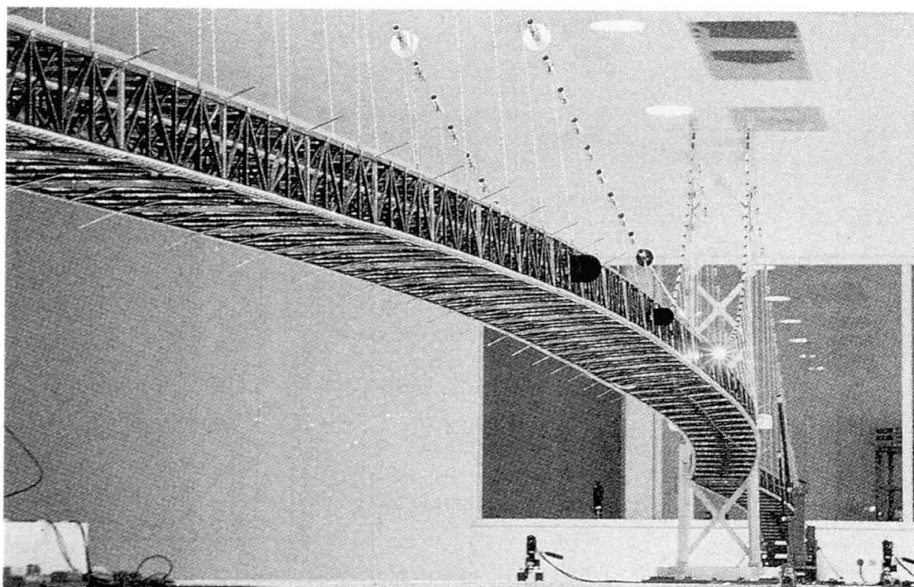

Photo 3 Displacement of the Akashi Kaikyo Bridge in Wind Tunnel Test

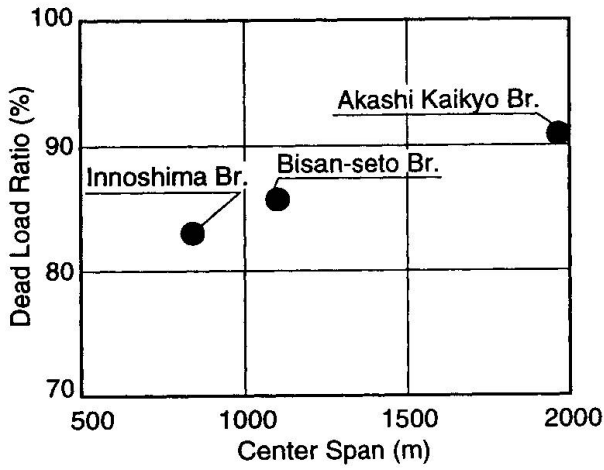

Fig. 12 Dead Load Ratio in Cable Tension Force

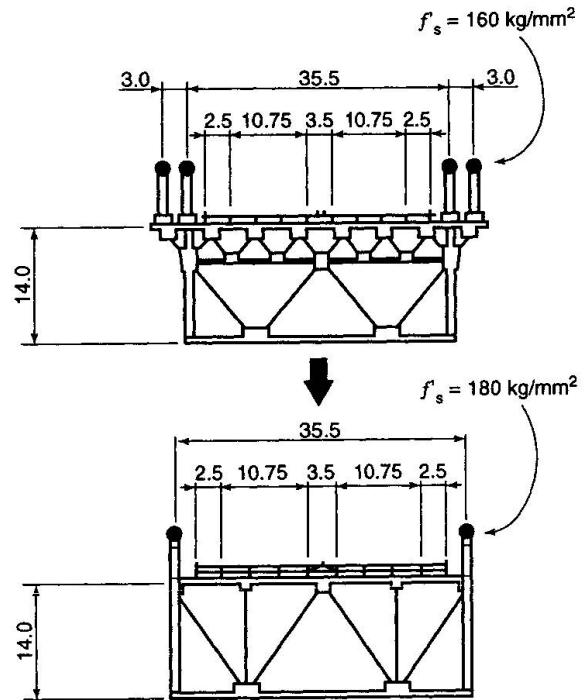

Fig. 13 Simplification of Structure by High Strength Steel Wire Cable

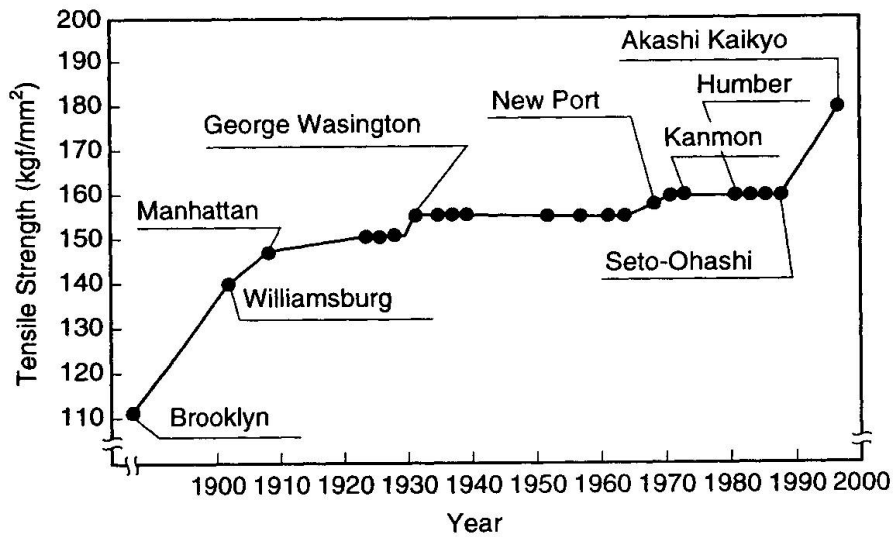

Fig. 14 Increase in Strength of Cable Wire

## 6. Construction of Superstructure

Main cables of suspension bridges in Honshu-Shikoku Bridges have been constructed by PWS method except for the tunnel anchor of Shimotsui Seto Bridge. The first step of cable construction is the spanning of pilot rope across sea from one tower to another. Fig. 15 shows the earlier method for Innoshima Bridge, in which buoyed rope afloat on sea was tugged by a boat while the sea lane was closed.

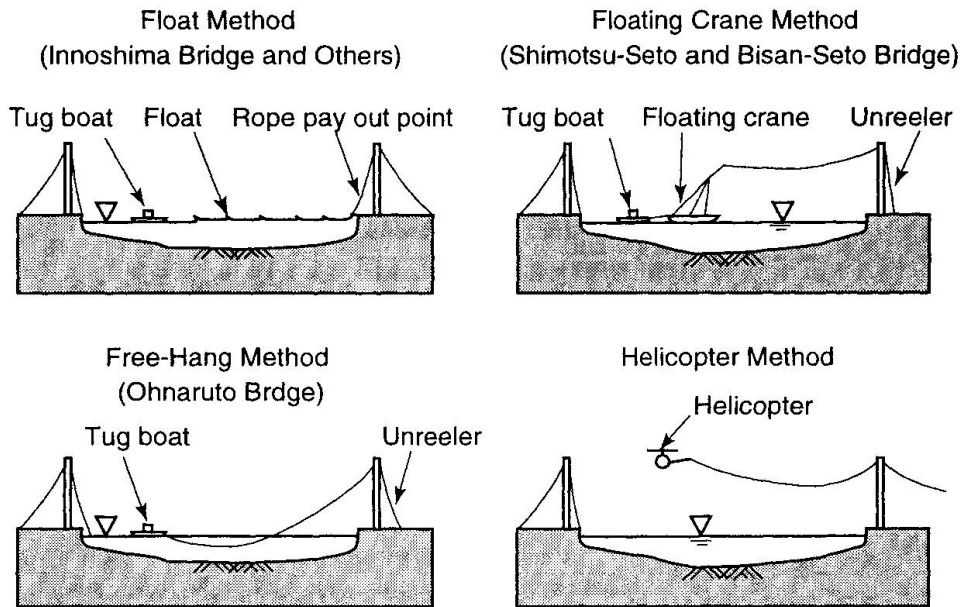

Fig. 15 Cable Crossing Method

Then at Ohnaruto Bridge, to shorten the shutdown time of navigation, the Free-Hang Method was applied, in which the rope was directly carried by tugboat. In the international navigation of Minami-Bisan Seto Bridge, etc., 65 m above sea level was open to allow sea traffic, the pilot rope was delivered by a floating crane. In Akashi Kaikyo Bridge, a helicopter was used for the first time in Japan to ferry the rope. The aramid fiber rope (Fig. 16) of light weight, high tensile strength was used to assure safety and operability of the helicopter.

When pilot ropes were stretched, the hauling system was installed to construct the catwalk as the scaffold for cable work. To assure wind stability and workability of catwalk, "storm rope" had been conveniently used, however, suspension bridges on and after the Akashi Kaikyo Bridge, some measures were taken to dispense with the rope for shortening construction period.

The convenient anti-corrosion measures for main cable have been as followings. After wire strands were squeezed and bundled together into the shape of a cable, the cable was coated with paste on the surface, lapped around by lapping wire, then

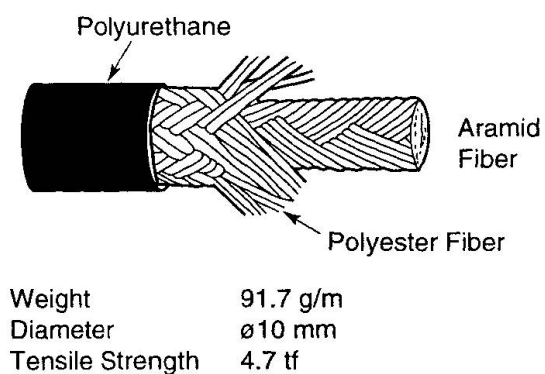

Fig. 16 Poly-Aramid Fiber Rope for Pilot Rope



painted to resist corrosion. According to later soundness check of main cables, however, some rust was identified. Since the cause of rust was regarded to be the moisture inside, dry air was fed in to avoid it as shown in Fig. 17. To ascertain air-feed and avoid the intrusion of moisture in a cable, the wire-lapped surface was covered with rubbersheet.

As to girder erection in the Akashi Kaikyo Bridge, as in the same manner as in the Minami-Bisan Seto Bridge, a larger portion of girder block was installed first, then standard block sections were stretched one after another. Contrary to this method, in the Kurushima Bridge of Onomichi-Imabari Route, an automatically positioning self propelling barge was developed to swiftly execute its box girder construction in the international navigation. When the barge comes to the area down below the construction point, it automatically fixes its position against the swift tidal flow, then the girder block, the weight of approximately 500 metric tons, on the barge will be lifted by a cable crane with the use of quick joint (Photo 4).

## 7. Conclusion

Along with Honshu-Shikoku Bridge Projects progress, the bridges have been increasingly enlarged in scale, various technical improvements and innovations have been made, and each of them has contributed to the dream of large scale bridge construction come true.

The construction of Honshu-Shikoku Bridges comes to an end when Onomichi-Imabari Route be completed in the spring of 1999. The wide range of technical advancement cultivated and developed at Honshu-Shikoku Bridge Projects, should also contribute to other bridge construction projects hereafter.

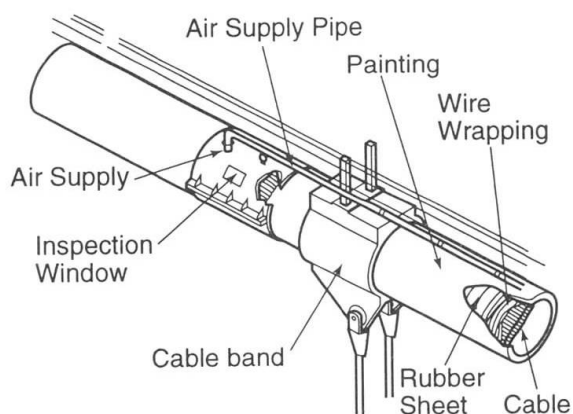

Fig. 17 Corrosion Protection System of Main Cable



Photo 4 The Large-Block Girder Erection by Dynamic Positioning System