

Zeitschrift: IABSE reports = Rapports AIPC = IVBH Berichte
Band: 79 (1998)

Artikel: Experimental study on isolation system with friction damping
Autor: Ogawa, Kazushi / Tamaki, Toshihrio / Yabe, Jun-ichi
DOI: <https://doi.org/10.5169/seals-59960>

Nutzungsbedingungen

Die ETH-Bibliothek ist die Anbieterin der digitalisierten Zeitschriften. Sie besitzt keine Urheberrechte an den Zeitschriften und ist nicht verantwortlich für deren Inhalte. Die Rechte liegen in der Regel bei den Herausgebern beziehungsweise den externen Rechteinhabern. [Siehe Rechtliche Hinweise.](#)

Conditions d'utilisation

L'ETH Library est le fournisseur des revues numérisées. Elle ne détient aucun droit d'auteur sur les revues et n'est pas responsable de leur contenu. En règle générale, les droits sont détenus par les éditeurs ou les détenteurs de droits externes. [Voir Informations légales.](#)

Terms of use

The ETH Library is the provider of the digitised journals. It does not own any copyrights to the journals and is not responsible for their content. The rights usually lie with the publishers or the external rights holders. [See Legal notice.](#)

Download PDF: 02.04.2025

ETH-Bibliothek Zürich, E-Periodica, <https://www.e-periodica.ch>



Experimental Study on Isolation System with Friction Damping

Kazushi OGAWA

Senior Mgr, Bridge Eng. Div.
Kawasaki Heavy Ind. Ltd
Akashi, Hyogo, Japan

Jun-ichi YABE

Senior Officer, Bridge Eng. Div..
Kawasaki Heavy Ind. Ltd
Tokyo, Japan

Tooru NISHIDA

Assist. Mgr, Akashi Techn. Inst.
Kawasaki Heavy Ind. Ltd
Akashi, Hyogo, Japan

Dong-Ho HA

Res. Eng., Bridge Eng. Div.
Kawasaki Heavy Ind. Ltd
Tokyo, Japan

Toshihrio TAMAKI

Staff Officer, Bridge Eng. Div.
Kawasaki Heavy Ind. Ltd
Tokyo, Japan

Fujikazu SAKAI

Dir., Kanto Techn. Inst.
Kawasaki Heavy Ind. Ltd
Noda, Chiba, Japan

Toshio SAITOH

Assist. Mgr, Bridge Eng. Div.
Kawasaki Heavy Ind. Ltd
Akashi, Hyogo, Japan

Summary

The displacement response of seismic-isolated bridges supported on the lead rubber bearings (LRB) or the high damping rubber (HDR) bearings can be very large to great earthquake like the Great Hanshin Earthquake. New type of seismic-isolation system to reduce the displacement response has been developed by the authors. This new system consist of friction damping bearings, which contain permanent displacement control mechanism by water pressure, and horizontal rubber springs. A series of shaking table experiment had been conducted for the performance verification of a new frictional damping device for seismic isolation of bridge. The excellent energy dissipation effect of friction was identified as the small displacement response with acceptable acceleration response. The comparison of the results of the experiment and the numerical simulation shows the suitability of the simulation.

1. Introduction

The Great Hanshin Earthquake in 1995 caused severe damages on the highway bridges. The seismic isolation systems are used to reduce the response during the earthquake by shifting the natural period of the structure out of the range of dominant earthquake energy and increasing the damping capacity. The isolation systems are recognized as efficient device to reduce the earthquake response. However, the displacement response of the bridges isolated by usual rubber bearings can be 30cm to 70cm to the great earthquake. The design of expansion joints and falling prevention system are difficult to such a large displacement. Therefore the isolation systems with less displacement response are desired. In this paper, the new seismic-isolation system^{1,2)}, the results of measurement of friction elements and the shaking table experiments of the similitude model are discussed. The results of the experiments show the efficiency of the isolators.



2. Isolation system with friction damping

The configuration of the isolation system with friction damping is shown in Fig. 1. The system consists of the horizontal rubber springs to lengthen the natural period of the bridge structure, and the friction bearings which support the weight of the structure and dissipate the vibration energy by friction. The characteristics of the isolation system with friction damping is as follows.

- (a) The vertical load is beared by the friction bearings, traffic vibration does not occur.
- (b) The acceleration response of the structure is almost same as the rubber bearings but the displacement response of the structure is well suppressed than by the rubber bearings.
- (c) If the residual displacement may occur after the earthquake, the restoration mechanism installed in the device using the water pressure can restore the residual displacement easily.

The isolation system with friction damping can be deformed in horizontal and rotational direction as shown in Fig. 2. The horizontal rubber springs need not bear the vertical force and need not energy dispersion and it is easy to design.

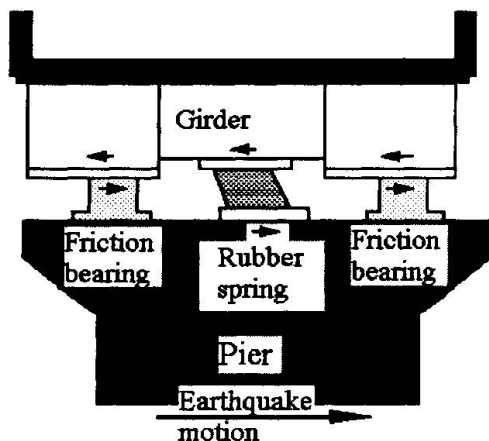

Fig. 1 Configuration of isolation system with friction damping

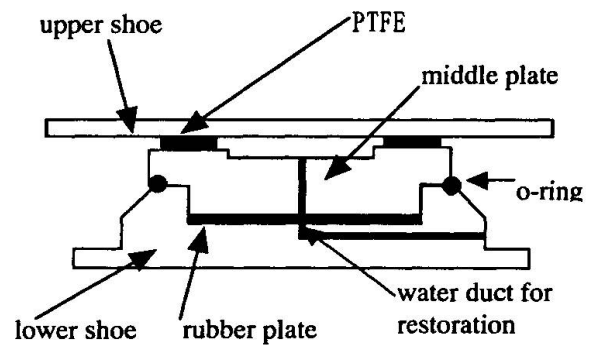

Fig. 2 Friction Bearing

3. Measurement of friction element

3-1 Experimental equipments

As shown in Fig.3, one SUS (stainless steel) plate inserted between the two lower shoes pressed each other is moved by the actuator. The water pressure induced into the cavity in the PTFE (Polytetrafluoroethylene) ring plate reduce the bearing pressure on the ring and the friction force. In this experiment, vertical force, horizontal force, relative displacement and water pressure are measured. The specification of the equipment and the measurement condition are shown in Table 1.

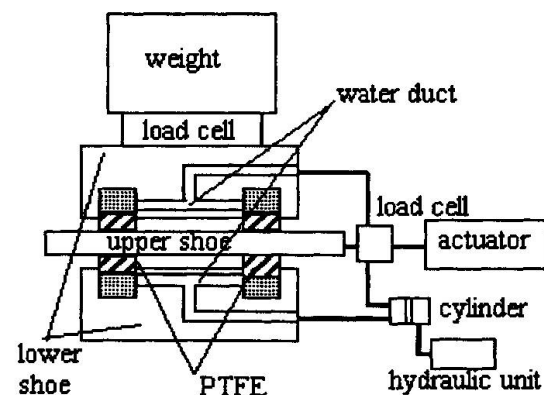

Fig. 3 Equipment for friction measurement

Table 1 Measurement condition

sliding plate	amplitude	135[mm]
	velocity	5~212[mm/s]
PTFE	bearing pressure	9.4,126[MPa]
	area	80[cm ²]
cavity	water pressure	0~58 [MPa]
	area	64[cm ²]

3-2 Results of measurement

The maximum sliding velocity of the PTFE to the SUS are obtained from the time history of the skidding displacement. The coefficients of friction are computed as the ratio of the horizontal force to vertical force. The relation of the friction coefficient and the sliding velocity is shown in Fig. 4. The friction coefficient of PTFE and SUS is small in low velocity region and 0.10 to 0.16 in the region higher than 5cm/sec.

The relation of the sliding velocity and the friction coefficient at each water pressure are shown in Fig. 5. The figure shows the tendency that the higher water pressure makes the friction coefficient smaller in spite of the sliding velocity. Therefore the residual displacement of the bridge can be restored easily by the water pressure. In the case of water pressure higher than 4.6-4.9[Mpa], a little water leakage was observed and the water on the interface of PTFE and SUS reduce the friction coefficient with lubrication effect.

4. Shaking table experiment

4-1 Experimental model

The objective bridge of this study is a 5-span continuous steel box-girder with concrete piers as shown in Fig. 6. The shaking table model simulates the dynamic property of the first mode in the longitudinal direction, and of the one span of the girder supported on the isolators above the pier in scale of 1/5. The mass of the model is 10 tons. The natural frequency of the model supported on the horizontal rubber springs is 1.2[Hz] ($\sqrt{5}$ times of the prototype). The dimension of the model is shown in Fig.7 and the photograph of the model on the shaking table in Fig. 8.

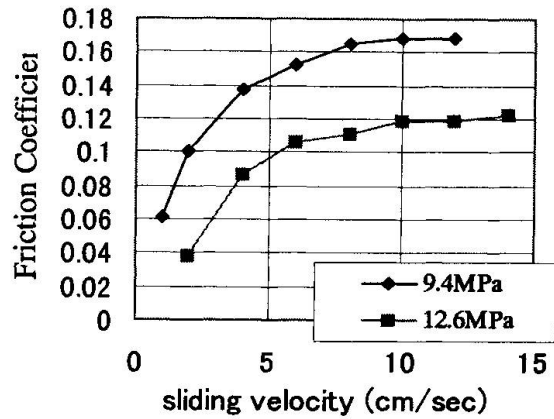
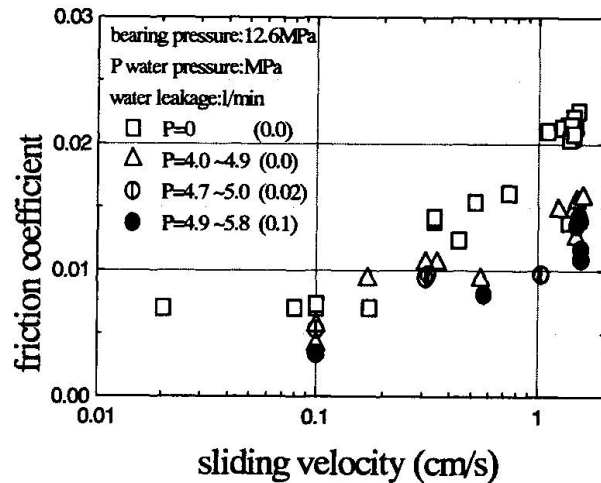
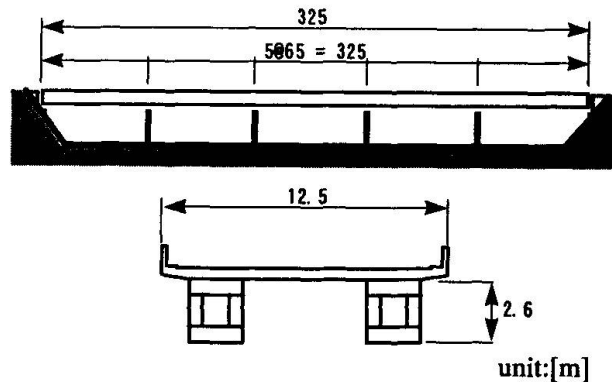
Fig. 4 Velocity and Friction Coefficient

Fig. 5 Water pressure and Friction Coefficient

Fig. 6 General view of 5-span continuous steel box-girder bridge

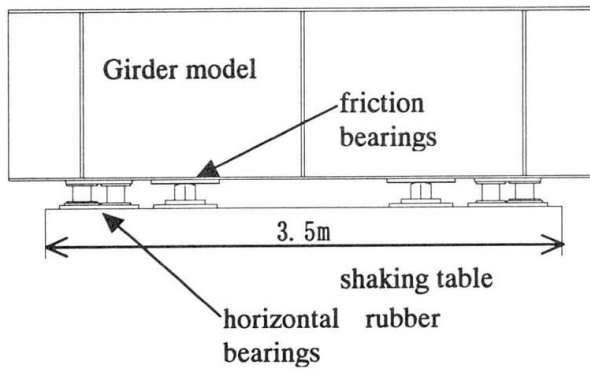

Fig. 7 Model for shaking table experiment

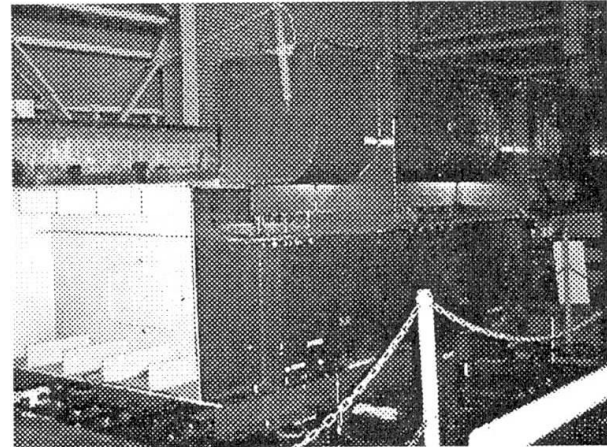
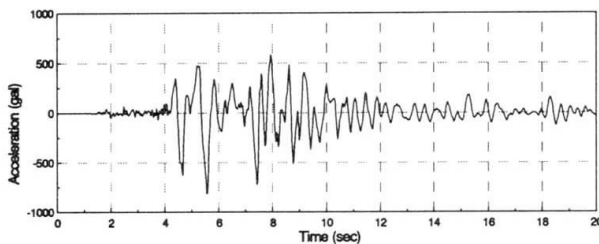

Fig. 8 Model on the shaking table

4-2 Input wave

The sinusoidal waves to investigate the basic characteristics of the model and the earthquake waves to investigate the response of the isolated bridge are used as the input to the shaking table. The earthquake inputs are computed as the response of the pier-girder 2DOF system subjected ground acceleration. The ground motions used for shaking table input are standard time history records for checking design ultimate horizontal strength³⁾ and the record of the Great Hanshin Earthquake⁴⁾. In Fig. 9 an example of the time history of the acceleration is shown.



(a) Acceleration at ground

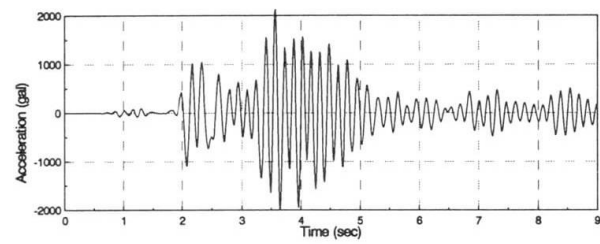

(b) Acceleration at pier

Fig. 9 Input Acceleration (JMA Kobe NS)

4-3 Numerical Simulation

The numerical model of the experimental model is described as a SDOF mechanical vibration system with Coulomb friction as Fig. 12. The equation of motion of the system in Fig.13 is written as follows.

$$\begin{cases} M\ddot{x} + C\dot{x} + Kx = -M\ddot{z} + F_r \\ F_r = -\mu_d Mg \operatorname{sgn}(\dot{x}) \end{cases} \quad (1)$$

When

$$\begin{cases} \dot{x} = 0 \text{ and} \\ | -M\ddot{z} - C\dot{x} - Kx | \leq \mu_s Mg \end{cases} \quad (2)$$

simulation is restarted with the condition

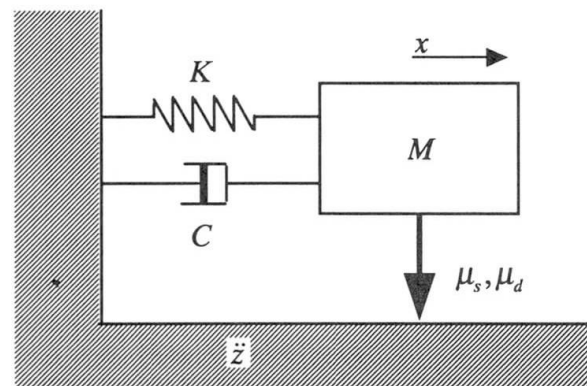

Fig. 10 SDOF simulation model

$\dot{x} = 0$. It means that when the relative velocity is zero and the acting force less than the static friction force, the motion will stop. In the numerical solution procedure of differential equation (1), it is difficult to judge the condition (2) exactly. We evaluated the condition by eq. (3) instead of eq. (2) using a small value ε and restart with the condition $\dot{x} = 0$.

$$\begin{cases} |\dot{x}| \leq \varepsilon \\ |-M\ddot{z} - C\dot{x} - Kx| \leq \mu_s Mg \end{cases} \quad (3)$$

Based on the results of measurement of the friction elements, we set the dynamic friction coefficient $\mu_d = 0.14$ and static friction coefficient μ_s as 0.04. Solution scheme by Adams-Gear method with variable time step (0.0001~0.001[sec.]) and $\varepsilon = 10^{-5}$ are used.

4-4 Results of shaking table experiment

a) Harmonic Excitation

Firstly harmonic excitations of the girder model supported on the horizontal rubber spring are measured. The acceleration amplitude of the shaking table was set to 4, 8, 16, 20 gal. The frequency response is shown in Fig.11. The resonance frequency changes from 1.42 Hz to 1.26 Hz with increase of input amplitude and it shows that horizontal rubber springs have slightly nonlinear stiffness. The damping ratios were from 0.025 to 0.031 and almost linear.

Next, in the case of girder supported on the friction isolator and horizontal rubber spring, the time history of acceleration is obtained as Fig. 12. In this figure the measurement results (solid line) and results of the numerical simulation (dashed line) are compared. The results of experiment and simulation are in good agreement and the simulation method and parameters are appropriate.

b) Earthquake Excitation

The comparison of time history of the girder on the horizontal rubber spring is shown in Fig.13. In this figure solid line indicates the experimental results and dashed line the simulated results of bi-linear SDOF model. Input wave is based on Kobe JMA NS record (Fig. 9). The difference of the maximum acceleration response is 1.7% and it shows that the property of the horizontal rubber spring is well described by bi-linear model.

The comparison of the time histories of the experiment and the simulation is shown in Fig. 14. This figure shows good agreement of the responses by the shaking table experiment and by the simulation considering Coulomb damping.

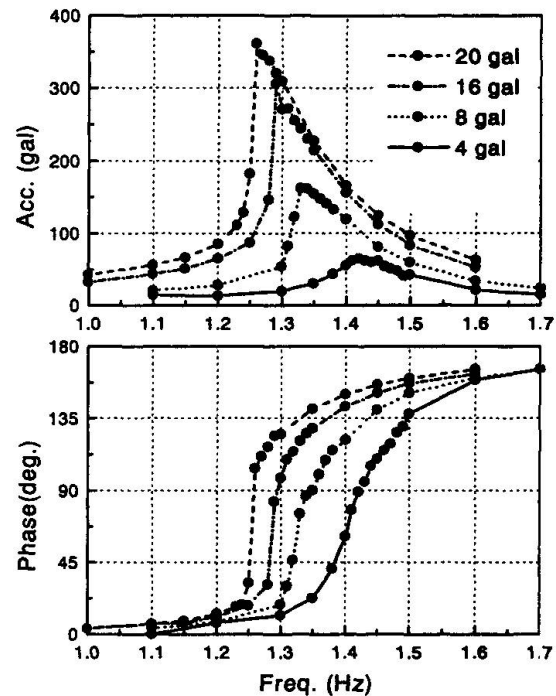

Fig.11 Frequency response of girder on rubber spring

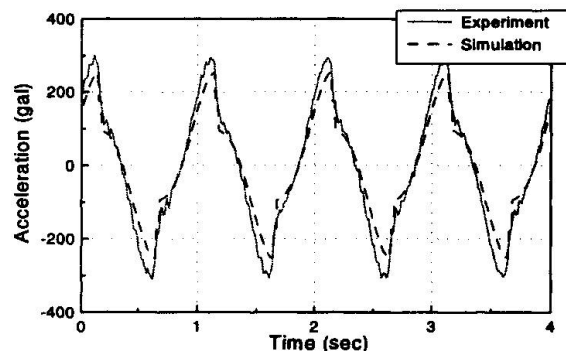

Fig. 12 The time history of the girder supported on isolators

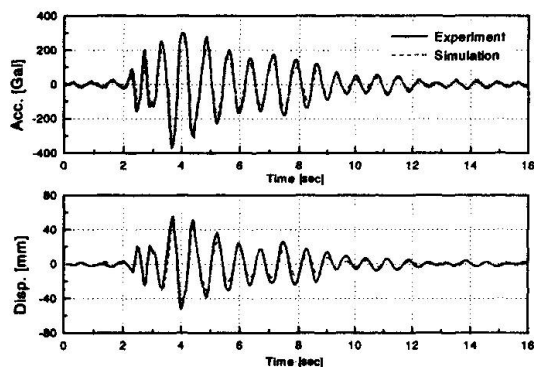

Fig. 13 Response of girder supported on rubber springs

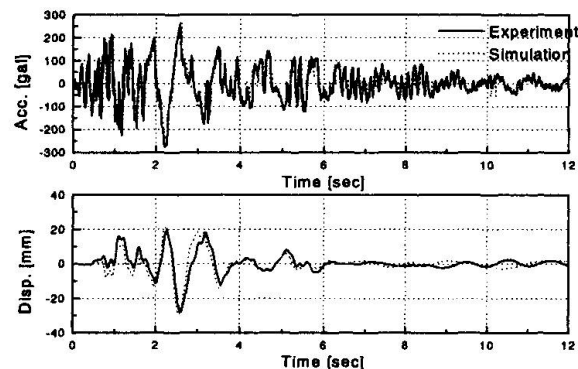

Fig. 14 Response of girder supported on isolation system with friction damping

4-5 Comparison of the isolation effect

Based on the results of the shaking table test, we compare the isolation effect of the isolation system with the friction damping and usual rubber isolator by the numerical simulation of the 2DOF model consists of the girder and the pier. In the simulation isolator with the friction damping is treated as a linear spring and Coulomb damping and usual rubber bearing is linear spring and dashpot of 15% of the critical damping. The maximum response of the girder to the earthquake waves are compared in the table 2. In this table it is shown that the acceleration response of both isolators are almost same, but the displacement response of the new isolator are much smaller than that of rubber bearings. This shows that the efficiency of the new isolator to suppress the displacement response.

Table 2 The comparison of isolation effect

Input wave	Isolator with Friction		Rubber bearing	
	Acc.	Disp.	Acc.	Disp.
Kaihoku	357	222	377	363
Itajima	373	239	438	415
Tsugaru	389	255	552	532
JMA Kobe	308	170	337	306
JR Takatori	735	604	725	685
Higashi Kobe	403	268	538	528

unit Acc.:gal, Disp. :mm

5. CONCLUSION

The authors discussed the friction measurement and shaking table test of the seismic isolation system with friction damping. The excellent energy dissipation effect of friction was identified as the small displacement response with acceptable acceleration response. A simple simulation with Coulomb damping model was achieved by using the experimental result. The comparison of the results of experiment and numerical simulation shows the suitability of this simulation.

References

- (1) Doi Y. et al, "Earthquake isolation of bridge using friction damping shoes", proc. of 1st Colloquium on seismic isolation and control, JSCE 1996.(in Japanese)
- (2) Tamaki T. et al, "Experimental study on the seismic isolation system", proc. of JSCE Ann. 1997.(in Japanese)
- (3) Civil engineering reserch center, "Temporaly mannual of design method for base-isolated highway bridges ", 1992.(in Japanese)
- (4) Japan meteorological agency, "Strong motion record in 1995 Great Hanshin Earthquake", 1995.