

Zeitschrift: IABSE reports = Rapports AIPC = IVBH Berichte
Band: 82 (1999)

Rubrik: Session 2: Composite structures

Nutzungsbedingungen

Die ETH-Bibliothek ist die Anbieterin der digitalisierten Zeitschriften. Sie besitzt keine Urheberrechte an den Zeitschriften und ist nicht verantwortlich für deren Inhalte. Die Rechte liegen in der Regel bei den Herausgebern beziehungsweise den externen Rechteinhabern. [Siehe Rechtliche Hinweise.](#)

Conditions d'utilisation

L'ETH Library est le fournisseur des revues numérisées. Elle ne détient aucun droit d'auteur sur les revues et n'est pas responsable de leur contenu. En règle générale, les droits sont détenus par les éditeurs ou les détenteurs de droits externes. [Voir Informations légales.](#)

Terms of use

The ETH Library is the provider of the digitised journals. It does not own any copyrights to the journals and is not responsible for their content. The rights usually lie with the publishers or the external rights holders. [See Legal notice.](#)

Download PDF: 02.04.2025

ETH-Bibliothek Zürich, E-Periodica, <https://www.e-periodica.ch>



The Development of Composite Cable-Stayed Bridges

Holger S. SVENSSON,
 Managing Director
 Leonhardt, Andrä und Partner
 Stuttgart, Germany



Holger Svensson, born 1945
 received his Diplom-Ingenieur
 (M.Sc.) degree in 1969.

He specialised in all aspects of
 the design and construction of
 long-span, mainly cable-stayed
 bridges all over the world.

Abstract

The first modern cable-stayed bridge was built in Sweden at Strömsund in 1955 with a composite beam.

Since the 80's composite cable-stayed bridges have dominated over all-concrete and all-steel ones. The main reasons are economy in materials and ease of construction. By using concrete rather than steel in compression and by using a concrete slab rather than an orthotropic deck, substantial savings against all-steel bridges are realised.

The construction of a composite beam can use small parts – main girders, cross girders, precast slabs – which can easily be lifted. They can simply be joined by bolting or welding the steel girders and by connecting the precast slabs with cast-in-place joints. Thus smaller lifting equipment and the absence of match-cast joints together with savings in cable steel favour composite beams against all-concrete ones.

In order to distinguish the different types of composite beams we split them into four groups:

- Composite main girders have a concrete roadway slab on top of a steel grid or beam (31 examples)
- A steel (or composite) beam in the centre spans is combined with concrete side spans (8 examples)
- Composite cross girders comprise a beam with concrete main girders and concrete floor slab supported by steel cross girders (2 examples)
- Composite roadway slabs are orthotropic steel decks stiffened by a substantial layer of concrete (3 examples)

Composite bridges are currently not only numerous, but they are the last 3 record span holders: the Yang Pu Bridge in Shanghai with 602 m in 1993, the Normandy Bridge in France with 856 m since 1995 and the Tataru Bridge in Japan in 1999 with 890 m. Important double deck composite bridges are the Kap Shui Mun Bridge in Hong Kong and the Öresund Bridge between Sweden and Denmark, see Figure 1.

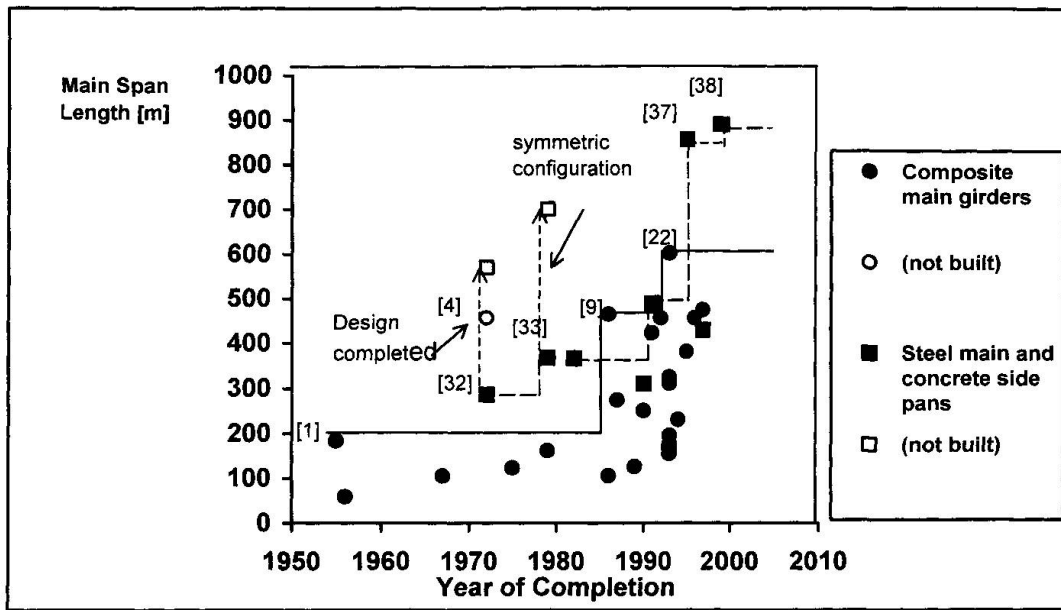

Figure 1. Development of span lengths, from Tables 1 and 2

Composite beams are most economic for main spans between about 350 m to 600 m, concrete approach bridges with a steel (or composite) main span govern between 650 m to 1000 m, see Figure 2.

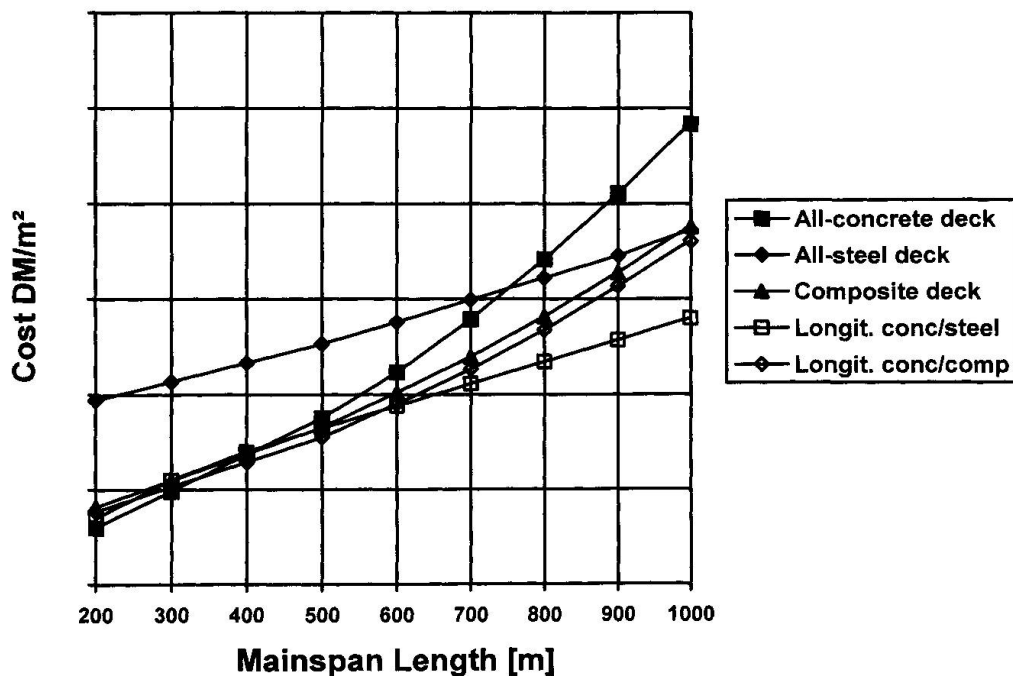

Figure 2. Unit costs for different types of cable-stayed bridges



Comparison of Slab Participation: Assumed for Design vs. FEA

David D. BYERS
Project Engineer,
HNTB Corporation
Kansas City, MO, USA

Steven T. HAGUE
Project Engineer,
HNTB Corporation
Kansas City, MO, USA

Steven L. McCABE
Professor
The University of Kansas,
Lawrence, KS, USA

David M. ROGOWSKI
Manager, Highway Bridge Design
HNTB Corporation
Kansas City, MO, USA

Abstract

Bridge design has developed through the centuries in a fashion that continues to improve upon the types of materials being used, as well as to use existing materials in a more efficient manner. Thus, as new materials, analysis methods, design concepts and construction methods are developed, they are frequently employed in bridges because of society's need for longer, more durable spans that can be built within ever-tightening public budgets. However, with new technologies such as the cable-stayed bridge, the rush to implement the concept frequently does not permit the answering of all the important engineering questions prior to implementation. To date, no information has been recorded in the literature that sheds light on the actual longitudinal stress distribution in the concrete deck portion of any of the composite steel and concrete cable-stayed bridges that have been constructed. Without this information, determining the extent to which the concrete deck is participating in the resistance of external force is unknown.

The use of Finite Element Methods (FEM) for design in civil-structural applications has been slow in evolving, primarily due to the cost associated with engineering design time and the general simplicity of most of the models encountered. In addition, proper modeling of structures as large as a typical cable-stayed bridge structure requires modern software to be pushed to its maximum capacity for operation. Consequently, modeling of structures of this nature for design is generally performed using a two-dimensional (2-D) or three-dimensional (3-D) direct stiffness model, making use of three degree of freedom (DOF) or six DOF nodes respectively. Cable-stayed bridge design is no exception and makes almost exclusive use of these less complex, direct stiffness analysis methods.

Results of a study in slab participation and resulting stress distribution in the concrete deck of composite cable-stayed bridge systems are presented. Analytical models developed using the ANSYS[®] finite element analysis package have been investigated for typical span arrangements, similar to those being designed and constructed in the United States. Particular attention is given to the longitudinal stress distribution across the deck section and the resulting effective slab width. Recommendations for the implementation of a *modified effective slab width* procedure, shown in Fig. A-1, are referenced.

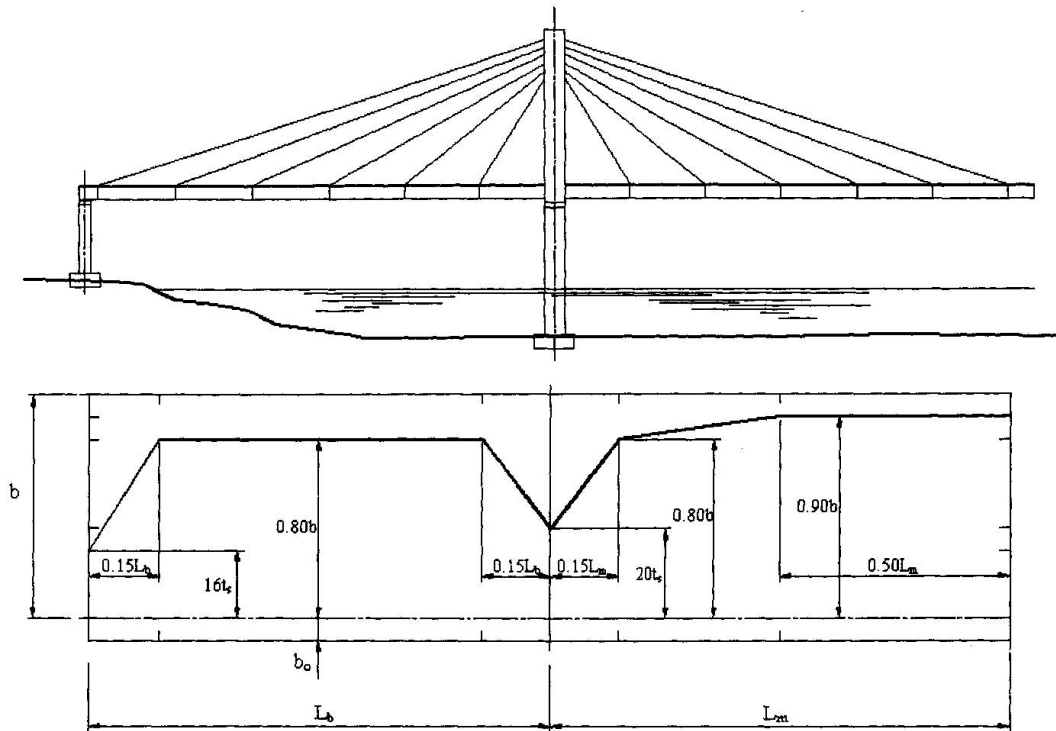

Figure A-1 Proposed Modified Effective Slab Width

Finally, a full scale model of a cable-stayed structure, similar in size to the 350 meter cable-stayed span over the Mississippi River currently under construction at Cape Girardeau, Missouri, USA; and the U.S. record 420 meter cable-stayed span over the Mississippi River near Greenville, Mississippi, USA was developed using both finite elements and conventional direct stiffness modeling. Stress results are compared for the full-scale model using both the *current method* of practice as well as the proposed *modified method*. Stress results, similar to those shown in Fig. A-2, are presented.

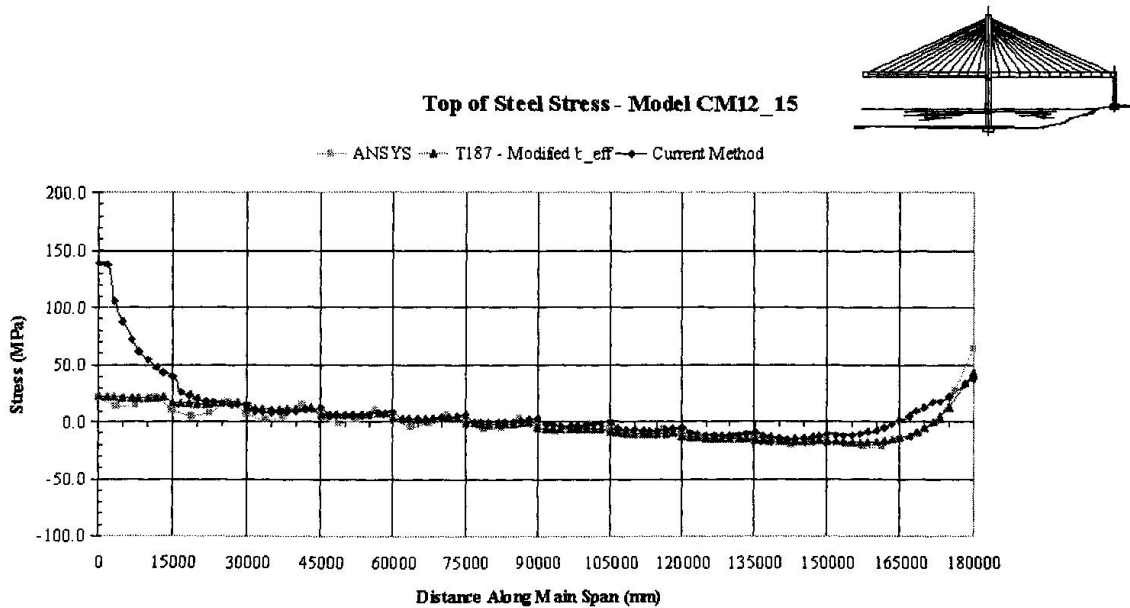

Figure A-2 Top Flange Stress Comparison



Yamuna Cable Stayed Bridge at Allahabad/Naini, India

Ejgil VEJE

M.Sc. Civil Engineer
COWI AS
Lyngby, Denmark

Poul Møller NIELSEN

M.Sc. Civil Engineer
COWI AS
Lyngby, Denmark

Flemming PEDERSEN

M.Sc. Civil Engineer
COWI AS
Lyngby, Denmark

Kent FUGLSANG

M.Sc. Civil Engineer
COWI AS
Lyngby, Denmark

Abstract

Most of the major river crossings in India have been designed as haunched concrete box girders constructed by the free cantilevering method, typically with spans of approximately 120m.

A feasibility study carried out for a new bridge across the Yamuna river at Allahabad has revealed that introduction of larger cable stayed spans are more cost effective than the traditional haunched girders. Therefore, a cable stayed bridge with a main span of 260m has been adopted for the deep portion of the river in the final design of the bridge (see figure 1).

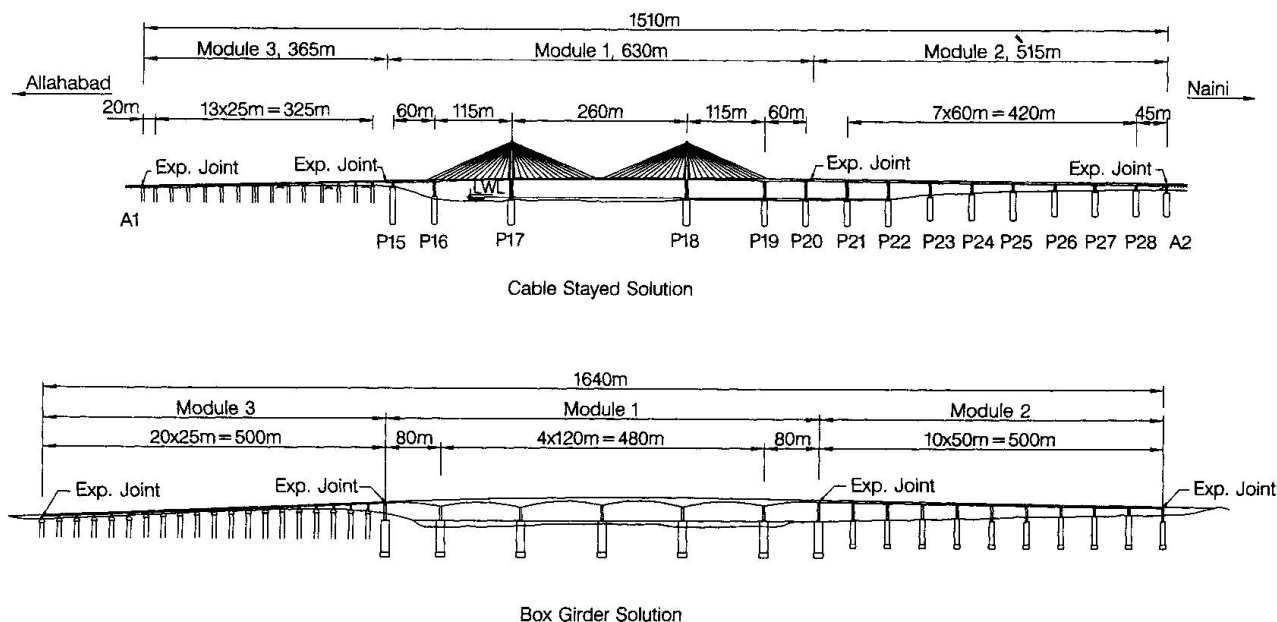

Figure 1. General Arrangement of Cable Stayed Solution and Box Girder solution

Design criteria applicable for the cable stayed bridge superstructure has been developed especially for the present project based on CBE-FIP Model Code 1990, as the Indian Codes are not suitable for design of this type of structure.

However, traffic and wind loads are in accordance with Indian Standards. The basic wind speed (peak gust velocity for 100 years return period averaged over about 3 sec. in 10m height) is 47 m/s. As a special case an accidental crowd loading of 5 kN/m² has been considered to act over the entire bridge deck due to religious festivals where millions of pilgrims gather at the confluence of Yamuna and Ganga rivers near the bridge site.

The final design of the bridge is illustrated in figure 2 and 3.

The 26m wide deck has two longitudinal girders and a 250mm thick slab supported per 5m on cross beams post-tensioned from one side by two tendons having 12 ϕ 15.7mm strands.

In the central part of the main span each longitudinal girder has 12 tendons of 19 ϕ 15.7mm strands and in the side span near the anchor pier 10 tendons.

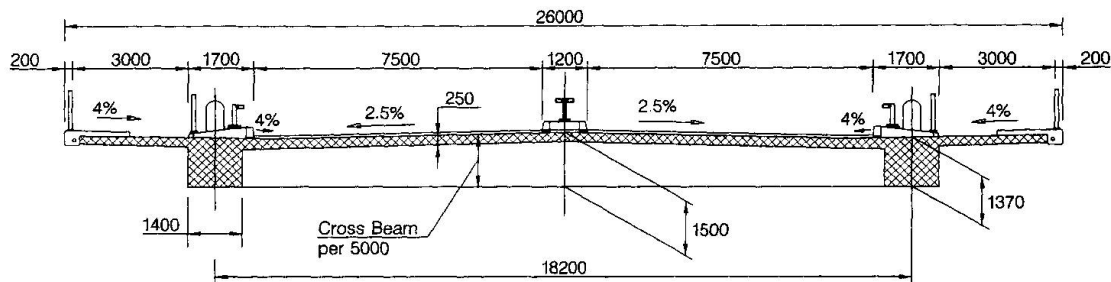

Figure 2. Section Through Cable Stayed Deck

The pylons have slender solid rectangular legs above the deck, while the lower part is hexagonal in shape.

The upper cross beam of the pylon is solid while the lower cross beam is hollow with a provision for access. Both cross beams are post-tensioned.

The cable stays are galvanised locked coil ropes with diameters between 76mm and 116mm and with minimum breaking load varying between 5.77 MN and 13.60 MN.

At the lower anchorage, the cable stays have sockets with thread and nut, and the stay forces are transferred to the longitudinal girders through steel plates.

At the top of the pylons, the stay cables are anchored by fork sockets to thick steel plates protruding from the pylon legs.

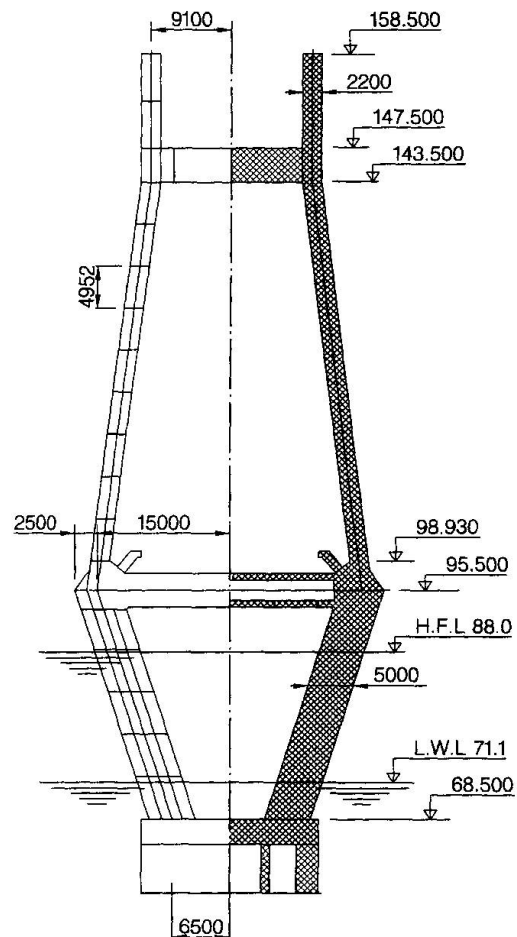

Figure 3. Section Through Pylon

The design of the bridge has focused on simplicity and consideration to local conditions and technology. At the same time considerable effort to achieve a light and elegant impression of the bridge has been aimed at. It is expected that the developed design may form the basis for several new cable stayed bridge across the numerous rivers in India in the coming years.



Probabilistic FE Analysis of a Cable-Stayed Composite Bridge

A. DE BOER

Civ. Eng.
Div of RWS,
Utrecht, The Netherlands

Ane de Boer, born in 1951, graduated as a Civil Engineer from TU Delft in 1988. At present he is senior structural research engineer in the Dutch Ministry of Transport, Public Works and Water Management.



P.H. WAARTS

Civ. Eng.
TU Delft & TNO,
Delft, The Netherlands

Paul Waarts, born in 1961, got his civil engineering degree at TU Delft in 1988. At present he is a project engineer at TNO and research assistant at TU Delft, faculty of civil engineering.



Abstract

1. Introduction

In 1998 a new cable stayed bridge was designed near the city of Kampen in the Netherlands. Figure 1 shows an artist impression of the cable stayed bridge to be built. The bridge has been designed by the civil engineering division of the Dutch Ministry of Transport, Public Works and Water Management. The cross-section of the main span has a composite character. The main span is built up out of a beam grid of steel. The concrete slab on top of the beam grid is initially used as compression zone in the total cross section of the bridge deck.

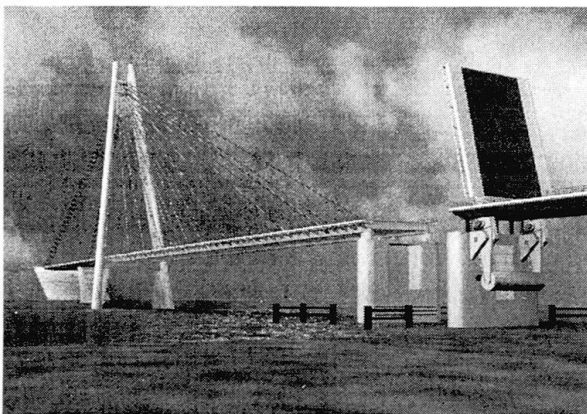

Figure 1: Artist impression

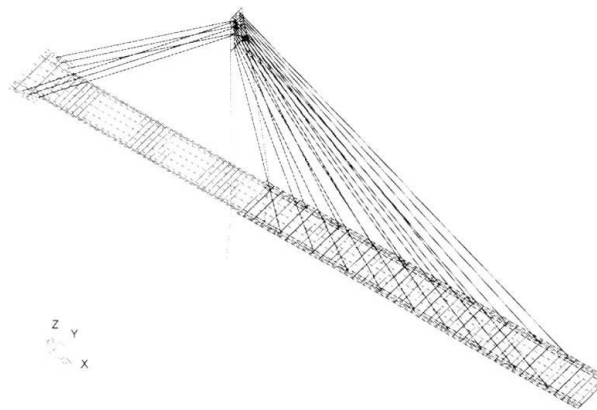

Figure 2: FE mesh of the 3-D model

In the design process, the safety of bridges is insured by means of partial safety factors for both strength and load parameters. As a result it is generally accepted that the structure as a whole matches the desired probability of failure. In the paper another method is followed. A full probabilistic analysis on the complete composite structure is performed using FE analysis.

2. Bridge Structure

Figure 2 shows the FE mesh of the bridge with a main span of 148.4 m, a side span of 92.5 m, while the height of the pylon reaches 70 m above the bridge deck. The net width of the bridge deck is 17 m, four traffic lanes of 3.25 m each and two maintenance lanes with a width of 2 m each. The bridge is supported at the both ends, the pylon and in the middle of the left side span. All supports are assumed to be springs, representing the soil's stiffness.

The cross-section of the main span has a composite character. The main span is build up with a beam grid of steel and is subdivided in sections with a length of 14.5 m. Each bridge deck section contains two main girders and four cross beam girders. On top of the beam grid lies a concrete slab with a thickness of 0.25 m. The cross beam girders on both sides of the connection between the stay cable and the bridge deck are heavier then the other two cross beam girders of the section. The connection between the concrete bridge deck and the beam grid is designed with a so-called stud connection (see Figure 3 for FE mesh) which is typical for steel concrete composite structures.

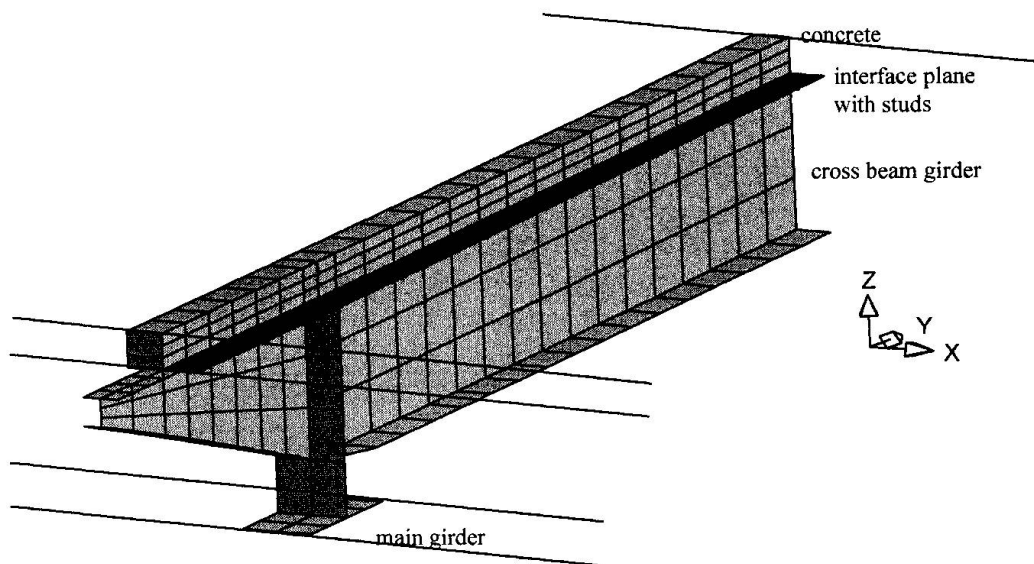

Figure 3 : FE mesh of half steel section main span

3. Results of the Stochastic Model

The thickness of the concrete deck, material properties of steel and concrete and the prestress force are random variables. The ultimate limit state is overstressing of either the cables or concrete-steel deck. The model has in total 58 independent stochastic variables. The probability of failure of the bridge structure is computed by means of the ACDS procedure. The 3-D model results in a reliability index $\beta = 5.05$ (intervals $4.8 < \beta < 5.4$), corresponding with a probability of failure $P_f = 4 \cdot 10^{-7}$.

The paper shows the possibility to perform a probabilistic analysis in the design environment. The probabilistic FE analysis shows that there is an additional safety compared to the safety required by the building codes. It may be concluded that this bridge, designed by using partial safety factors, is much safer then required, at least for the limit states considered.



A Method For The Creep Analysis Of Composite Cable-Stayed Bridges

Gan XIA
Civil Engineer
Ruhr-Universität
Bochum, Germany

Rolf KINDMANN
Professor Dr. -Ing.
Ruhr-Universität
Bochum, Germany

Gan Xia, born 1963, received his Master degree in civil engineering from Southeast Univ., Nanjing, P.R. China. He is currently a research assistant at Ruhr-University Bochum. His research interests include the time-dependent behaviour of composite structures.

Rolf Kindmann, born 1947, worked for one of the greatest German companies for 10 years. He was head of the technical departments for the design and construction of structures. Since 1990 he is professor for steel and composite structures at the University in Bochum.

Abstract

In general, as an internally heterogeneous structure with external elastic restraints the 'exact' creep analysis of composite cable-stayed bridges has to be performed by using numerical step-by-step techniques with more than 100 calculation steps. The so-called one-step method which is presently based on some solutions by using dischinger method (rate of creep method) or based on the age-adjusted effective modulus (AAEM), is apparently applicable for most practical designs. The solutions for composite cross sections obtained by using dischinger method or the usual AAEM method, however, inevitably have errors, which in some cases are negligible, but in other cases unnegligible. This paper proposes a one-step method for the creep analysis of complex composite structures including composite cable-stayed bridges which is based on a method newly developed for the creep analysis of composite sections. The creep analysis of composite sections by using the new method is mathematically exact on the usual hypotheses. Therefore, the accuracy of the results by using the new method is better than ones by using the AAEM method or the dischinger method.

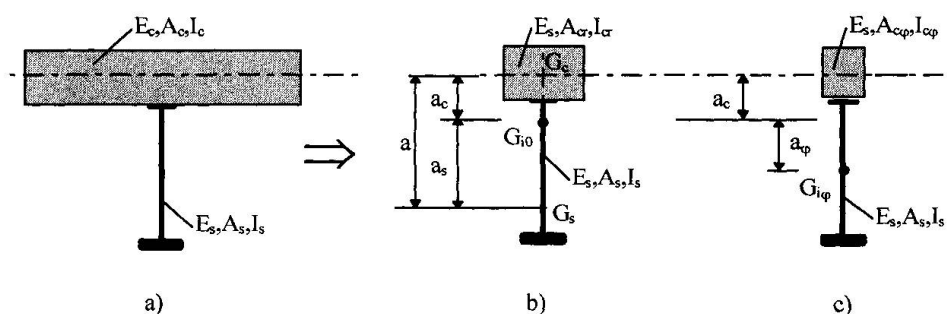

Fig. 1 a) Original cross section b) Fictitious cross section for elastic analysis c) Fictitious cross section for creep analysis

In order to perform the creep analysis of statically indeterminate composite structures, a fictitious transformed section for creep analysis which is similar to the transformed cross section for elastic analysis of composite structures is introduced (see Fig.1) and equivalent loading vectors for sustained loads are derived from the results of creep analysis of composite sections. The calculation of the properties of the fictitious transformed sections and equivalent loading vectors



can be easily implemented in a usual finite element program for the elastic analysis of structures. The creep effects can be then evaluated by using the finite element program by means of the properties of the fictitious transformed sections. It should be noted that the structure for creep analysis has a system line which is different from that for elastic analysis (i.e. a remove of a_φ).

To show its application, redistribution of internal forces due to creep in a cable-stayed bridge with composite cross section shown in Fig. 2 is evaluated by using the presented method. The elastic internal forces $N(t_0)$, $M(t_0)$ and the change of internal forces N_φ , M_φ due to creep for sustained load $g=300$ kN/m are illustrated in Fig.3.

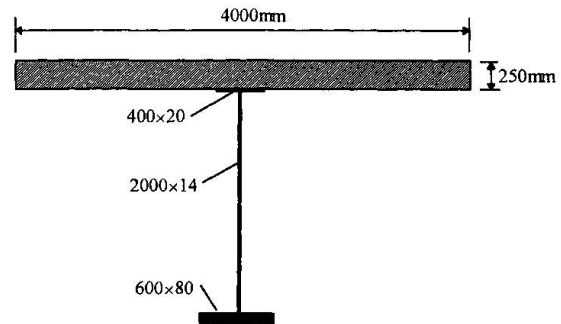

Fig. 2 Cross section

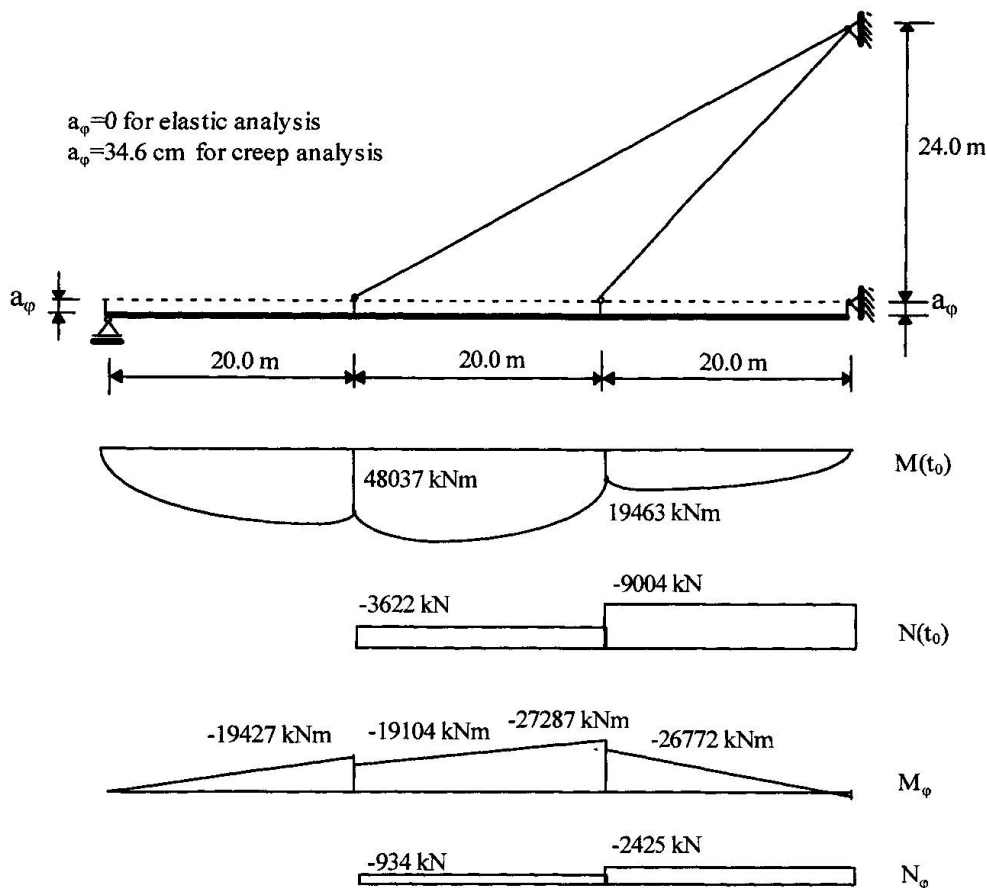

Fig. 3 Example



Composite Structures in the Øresund Bridge

Henrik CHRISTENSEN
Civil Engineer MSc
Øresundskonsortiet
Malmö, Sweden

Henrik Christensen received his degree from the Technical University of Denmark in 1987. He joined Øresundskonsortiet in 1994 and is Design Manager for the bridge.

Kaj MADSEN
Civil Engineer MSc
Gimsing & Madsen A/S
Horsens, Denmark

Kaj Madsen received his degree from the Technical University of Denmark in 1959. He is a director of Gimsing & Madsen since he co-founded the firm in 1969.

Christian Riis PETERSEN
Civil Engineer MSc
ISC Consulting Engineers A/S
Copenhagen, Denmark

Christian Riis Petersen received his degree from the Technical University of Denmark in 1978. He is chief engineer in the structural department at ISC where he has been employed since 1984.

Abstract

The conceptual design by ASO Group for the two-level Øresund Bridge included both an upper road deck in concrete and a lower railway deck in concrete. Both concrete decks acted in combination with the two longitudinal chords as part of the upper and lower truss flanges.

The 7.8 km long bridge was tendered in 1995 as a so-called 'detailed design and construct' contract, where the main dimensions were fixed by contractual definition drawings while the Contractor was made responsible for the detailed design. The definition drawings defined the geometry and materials to be used for the bridge, however the drawings also defined the few cases where the tenderer had a choice and the limits of his choice.

For the upper and lower decks the tenderers were free to choose between having steel decks or concrete decks. The successful tenderer, Sundlink Contractors HB selected concrete for both upper and lower decks of the 6.4 km long Approach Bridges.

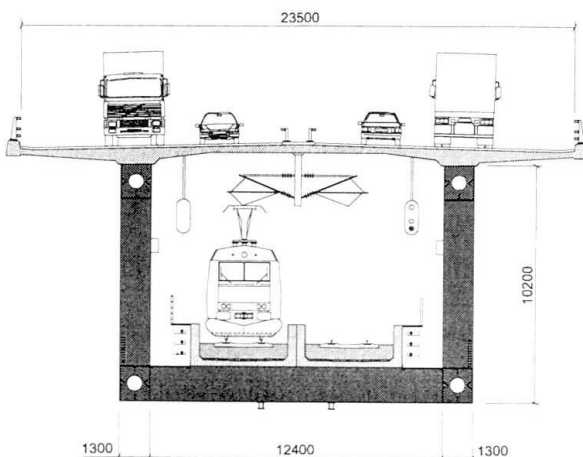

Cross section approach spans

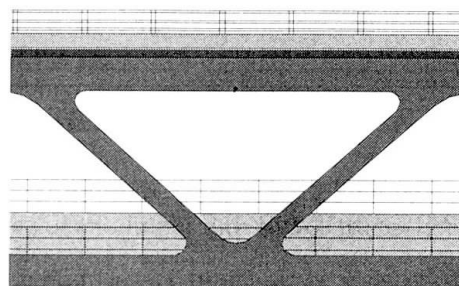

20m truss module

For the 1.1 km long cable-stayed High Bridge concrete was also chosen for the upper deck but a lower steel deck was chosen as the weight saving was found important in the 490 m main span.

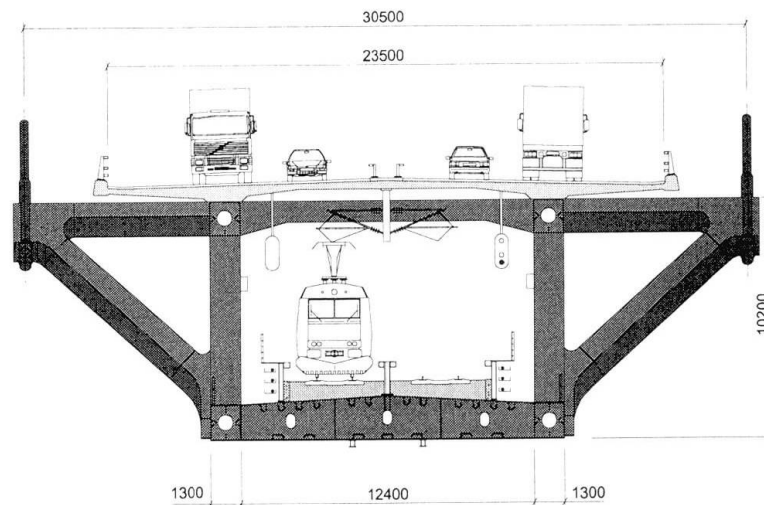

Cross section cable-stayed spans

The ASO Group (Ove Arup & Partners, SETEC TPI, Gimsing & Madsen and ISC) developed the bridge design for a design competition in 1993 and was appointed as the Owner's bridge consultant to develop the concept into tender documents. A number of detailed studies and investigations in particular for the composite solution were carried out at pre-tender stage as this solution was expected to be chosen by most tenderers.

The basic codes of practice for the design of the Øresund Bridge are the Eurocodes, which at the time of tender were only available in preliminary editions valid for building structures. ASO Group therefore carried out a comprehensive study of shear connections between steel and concrete, partly to assess the viability of alternatives to headed studs and partly to determine the fatigue characteristics of shear connections.

At the upper deck concentrated normal forces are introduced in the concrete at the nodal points. This leads to a high concentration of shear studs in these regions but does not give rise to particular problems. At the lower deck the transfer of the normal force from steel to concrete is more complicated, as the forces from the truss nodes pass through a steel crossbeam to the concrete troughs. The contractor's designer carried out the detailed design of the connections, while ASO Group carried out parallel analyses including investigations of alternative solutions, among others a separation of the concrete troughs from the steel structure.