

Zeitschrift: Eclogae Geologicae Helvetiae
Herausgeber: Schweizerische Geologische Gesellschaft
Band: 63 (1970)
Heft: 1: Geochronology of phanerozoic orogenic belts : papers presented at the "Colloquium on the Geochronology of Phanerozoic Orogenic Belts"

Artikel: Polymetamorphism in the Monte Rosa, Western Alps
Autor: Hunziker, Johannes C.
DOI: <https://doi.org/10.5169/seals-163826>

Nutzungsbedingungen

Die ETH-Bibliothek ist die Anbieterin der digitalisierten Zeitschriften. Sie besitzt keine Urheberrechte an den Zeitschriften und ist nicht verantwortlich für deren Inhalte. Die Rechte liegen in der Regel bei den Herausgebern beziehungsweise den externen Rechteinhabern. [Siehe Rechtliche Hinweise.](#)

Conditions d'utilisation

L'ETH Library est le fournisseur des revues numérisées. Elle ne détient aucun droit d'auteur sur les revues et n'est pas responsable de leur contenu. En règle générale, les droits sont détenus par les éditeurs ou les détenteurs de droits externes. [Voir Informations légales.](#)

Terms of use

The ETH Library is the provider of the digitised journals. It does not own any copyrights to the journals and is not responsible for their content. The rights usually lie with the publishers or the external rights holders. [See Legal notice.](#)

Download PDF: 01.04.2025

ETH-Bibliothek Zürich, E-Periodica, <https://www.e-periodica.ch>

Polymetamorphism in the Monte Rosa, Western Alps

by JOHANNES C. HUNZIKER

Universität Bern, Mineralogisch-petrographisches Institut, Sahlistrasse 6, Bern

ABSTRACT

An isochron of eight total rock samples of granites from the Monte Rosa nappe, gives an age of 310 ± 50 m.y. with an initial $\text{Sr}^{87}/\text{Sr}^{86}$ value of 0.712 ± 0.007 . This is interpreted as the age of the chemical formation of the granite.

Another event was found in the gneissic parts of these granites, where a total rock isochron gives an age of 260 ± 10 m.y. with an initial $\text{Sr}^{87}/\text{Sr}^{86}$ value of 0.713 ± 0.004 .

The Permian muscovite ages in the Monte Rosa nappe together with this 260 m.y. isochron, yield strong evidence for a Permian phase of the Hercynian metamorphism in this area.

Early Alpine tectonic movements have been demonstrated by a 125 ± 20 m.y. whole-rock isochron in strongly deformed gneisses from the front of the nappe (initial $\text{Sr}^{87}/\text{Sr}^{86}$ 0.728).

Through the analysis of over fifty Alpine phengites and biotites of the region, the time of Alpine metamorphism can be fixed at 38 ± 2 m.y. Mica age-determinations from the Simplon Centovalli fault zone, verify the existence of an age-discontinuity on either side of this zone. On the northeastern side, the biotite ages are all around 11 m.y. while on the southwestern side, the ages increase normal to the fault-zone from 15 m.y., to 22 m.y., over a distance of about 4 km. A vertical dislocation of 5–8 km is postulated.

Geology and Interpretation of the Age Data

The petrographic work of P. BEARTH (since 1952, see references) as well as the isotope work of E. JÄGER (mainly compiled in E. JÄGER, E. NIGGLI, and E. WENK, 1967), has shown that the Monte Rosa nappe represents a suitable area for detailed age study.

The Monte Rosa nappe is an Upper Pennine element in which the epizonal Alpine metamorphism did not succeed in destroying all the Prealpine features (see Fig. 1). Therefore, it was expected that, with a detailed Rb-Sr study, signs of the previous history of the Pennine nappe could be found. The geological side of the problem can be best illuminated by the evolution diagram of the western Alps after P. BEARTH (1961) and many others (see Fig. 2).

A catametamorphosed crystalline complex is intruded by granites in Upper Carboniferous time. After a discontinuity we find a weakly metamorphosed Permo-carboniferous series. On top of this, separated from the former by a second discontinuity, Permian sediments are found. This sequence is covered by the Mesozoic "Bündnerschiefer", with their ophiolites. The sequence below the Permian is the so-called crystalline basement. The whole series was affected by epizonal Alpine metamorphism.

The pregranitic metamorphism could not be dated. The analysed samples were collected too near to the granite contact, and had therefore exchanged their Rb and

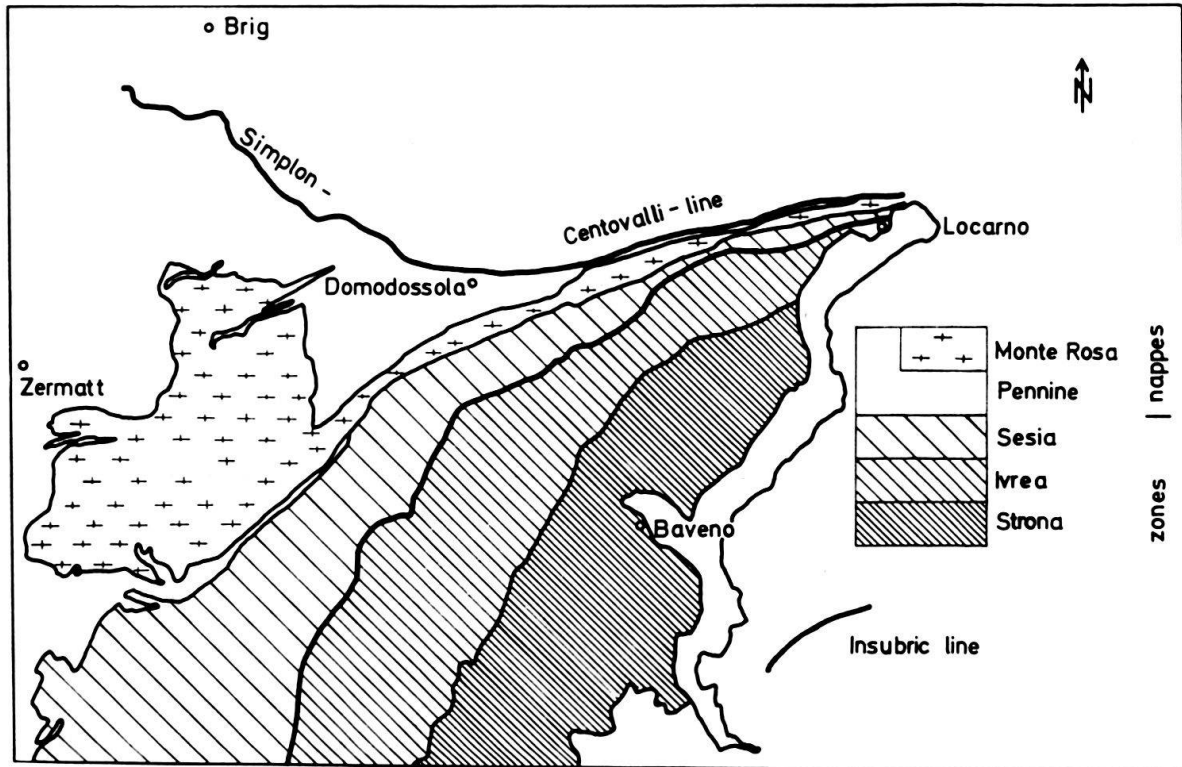

Fig. 1. Generalized tectonic map of the Central Pennine region, showing the position of the Monte Rosa nappe.

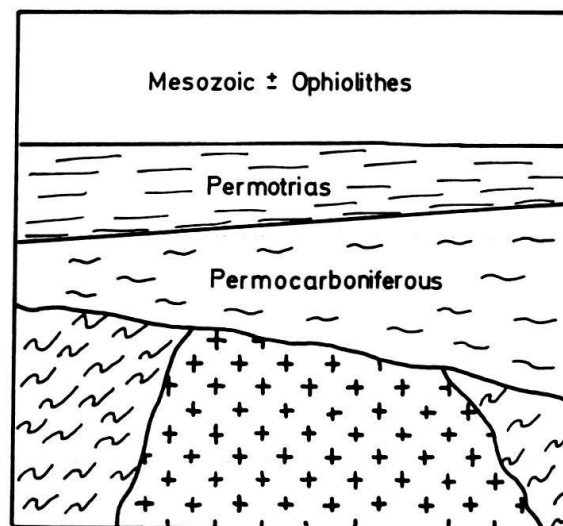

Fig. 2. Evolution diagram of the western Alps.

Sr with the granite. They lie on the same isochron as the granite. The catamorphic mineral association implies a metamorphism during early paleozoic time, after H. J. ZWART (1967).

The time of the bulk formation of the granites is defined by an isochron of weakly deformed Monte Rosa granites (see Fig. 3). This isochron gives an age of 310 ± 50

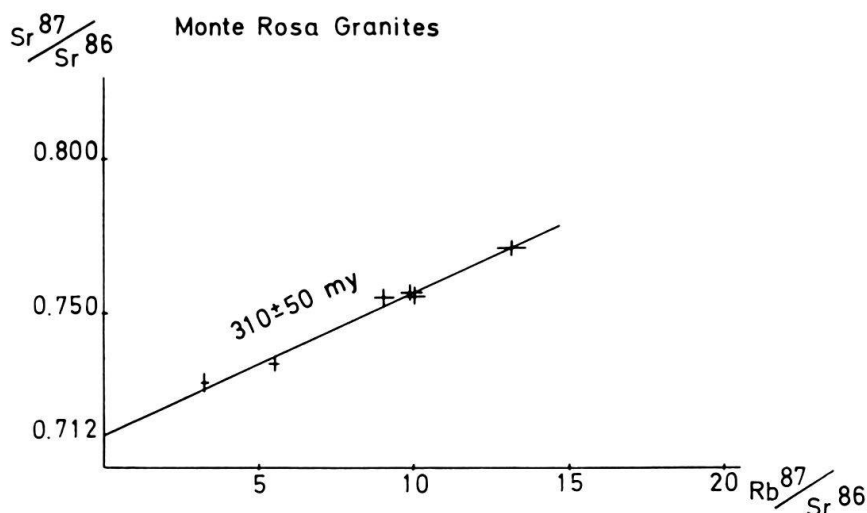

Fig. 3. Rb-Sr total rock isochron of only weakly deformed Monte Rosa granites.

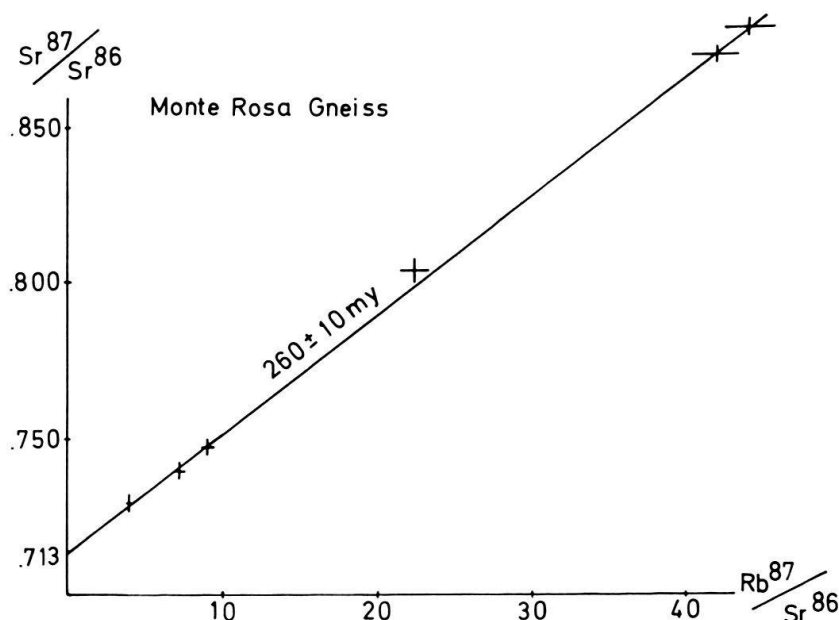

Fig. 4. Rb-Sr total rock isochron of Monte Rosa gneiss.

m.y. The initial $\text{Sr}^{87}/\text{Sr}^{86}$ value of 0.712 ± 0.007 is quite normal for granites in the Alps. The second event was found in the gneissic Monte Rosa granites. These rocks give a total rock isochron age of 260 ± 10 m.y., with an initial $\text{Sr}^{87}/\text{Sr}^{86}$ value of 0.713 ± 0.004 (see Fig. 4 and Table 1).

The problem is whether this latter age represents a metamorphic event, a magmatic phase, or a combination of both. We favour the idea of a Permian metamorphism. The assumption of a Permian metamorphism of the Upper Carboniferous granites is based upon the following four facts.

- (1) The Prealpine muscovites of the area yield ages of about 250 m.y. (J. C. HUNZIKER, 1969). These muscovites are oriented in a gneissic texture, the age of which was, until now, thought to be Alpine. The Permian muscovite ages show clearly that this texture must therefore be of Prealpine origin, and only reactivated during Alpine metamorphism. This latter reactivation is ascertained through the Alpine phengites which are also oriented in this texture.
- (2) A whole-rock isochron of deformed granites yields an age of 260 ± 10 m.y.
- (3) Younger undeformed granite dykes lie on the same isochron as in (2), proving magmatic activity at the same time.
- (4) Rocks of the partly sedimentary, presumably Permocarboniferous cover of the granites, define a preliminary isochron of 277 m.y. The error is unfortunately too great to ascertain an age difference between these and the gneissic granites. (A more detailed work on this subject is in preparation.)

The Rb and Sr isotopes were homogenized in these rocks at nearly the same time as in the gneissic granites.

We can therefore conclude: During Permian times the Hercynian muscovites were either formed or rejuvenated and oriented in the metamorphic texture during this metamorphism. The granites were partly foliated, proving tectonic movements. Core rock and cover rock of the complex exchanged their Rb and Sr isotopes. Nothing is missing for a real metamorphism.

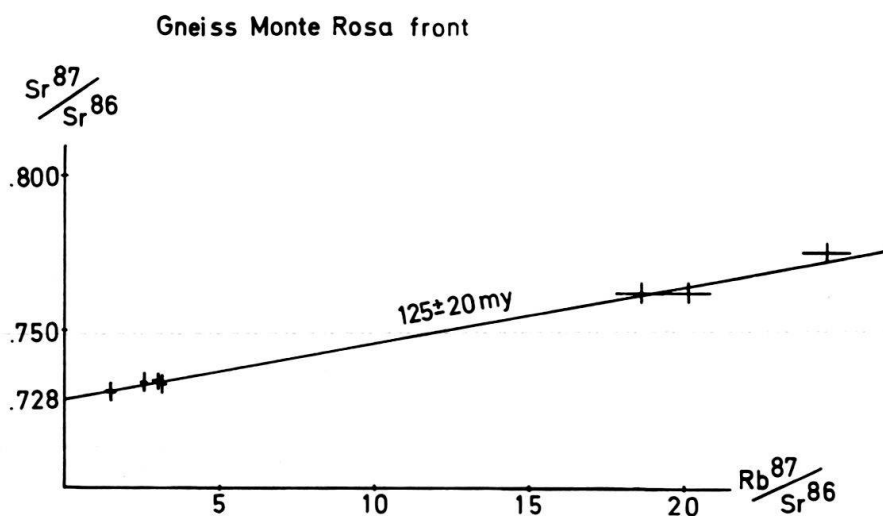

Fig. 5. Rb-Sr total rock isochron of Monte Rosa gneiss (front part of the nappe).

During Triassic, Jurassic, and Lower Cretaceous times the area was characterized by a rather quiet sedimentation, as can be seen in the parautochthonous sediments of the "Mischabel-Rückfalte" (P. BEARTH, 1961). Early Alpine tectonic movements are demonstrated with a 125 ± 20 m.y. whole-rock isochron (see Fig. 5) on strongly deformed Monte Rosa gneisses from the front of the nappe. This event was also found in the front part of the Monte Leone nappe (129 m.y., E. JÄGER, J. C. HUNZIKER, and S. GRAESER, in preparation); in the Sesia-zone (110 m.y., J. C. HUNZIKER, in preparation); and in the Roffna-Gneiss (HANSON et al., 1968).

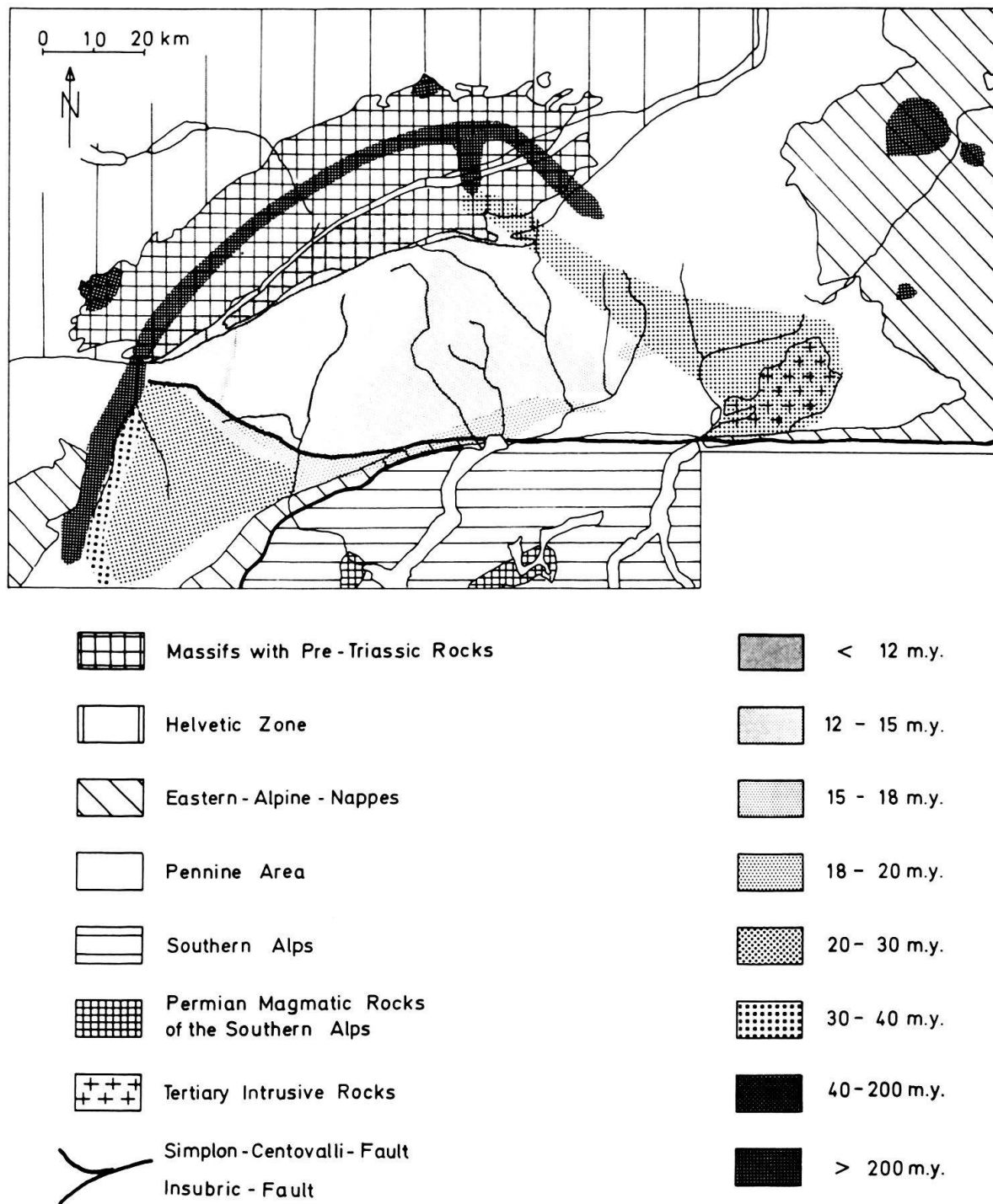

Fig. 6. Regional pattern of the Alpine Rb-Sr ages on biotites according to E. JÄGER and J. C. HUNZIKER (1969).

The rest of the history deals with the Alpine metamorphism and with the cooling after this metamorphism, as has been shown with mica ages.

Since the borders of the zone of Alpine staurolite-chloritoid (E. NIGGLI and C. R. NIGGLI, 1965), of tremolite-dolomite (V. TROMMSDORFF, 1966), and Alpine-rejuvenated muscovite (E. JÄGER, E. NIGGLI and E. WENK, 1967) coincide, E. JÄGER deduced a

temperature of about 500°C for the Alpine rejuvenation of Hercynian muscovite under regional metamorphic conditions. For the rejuvenation of biotite under analogous conditions, E. JÄGER gives a temperature of about 300°C.

P. BEARTH (1967), based on mineral paragenetic criteria, assumed a temperature between 450 and 500°C during the Alpine metamorphism for the Monte Rosa crystalline.

Our Alpine phengites in coexistence with quartz and biotite (see J. C. HUNZIKER, 1969), crystallized, according to B. VELDE (1965) and B. VELDE and J. KORNPORBST (1969), at temperatures above 450°C. They therefore must date an event very close to the temperature climax of Alpine metamorphism.

Biotite, as well as phengite ages show a regional pattern (see Fig. 6 and J. C. HUNZIKER and P. BEARTH, 1969). The biotite ages change from below 11 m.y. in the northeast, in the Simplon area, to as much as 32 m.y. in the southwest, in the Zermatt region. This change is explained by differences in the postmetamorphic lifting of the region. As a consequence of this lifting and erosion we have different cooling ages. The southwest part was lifted before the northeast. This implies that the southwestern part remained only for a short time under conditions of elevated temperatures of metamorphism. On the other hand, the northeastern part of the region stayed at higher temperatures for 25 m.y., that is, from the time of metamorphism until the closing time of the youngest biotites, some 11 m.y. ago. The age pattern of the phengites is quite analogous, but the latter are about 7–8 m.y. older than the biotites from the same rock.

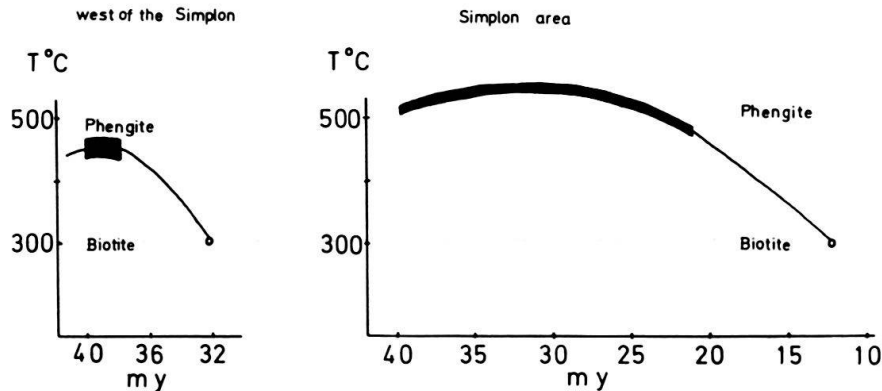

Fig. 7. Cooling history of the Alpine metamorphism in the Simplon-area and west of it.

This age difference between light and dark mica has already been described by E. JÄGER (in E. JÄGER, E. NIGGLI and E. WENK, 1967) in the Lepontine area. There, JÄGER calculated a cooling rate of 25°C/1 m.y.

To date the time of metamorphism, we must only consider the oldest mica ages. For the region of Zermatt, we get the cooling pattern of the Alpine metamorphism illustrated in Figure 7.

The thermal culmination can thus be fixed at 38 ± 2 m.y. After the time-scale of the Holmes Symposium (W. B. HARLAND et al., 1964), this would be the Eocene-

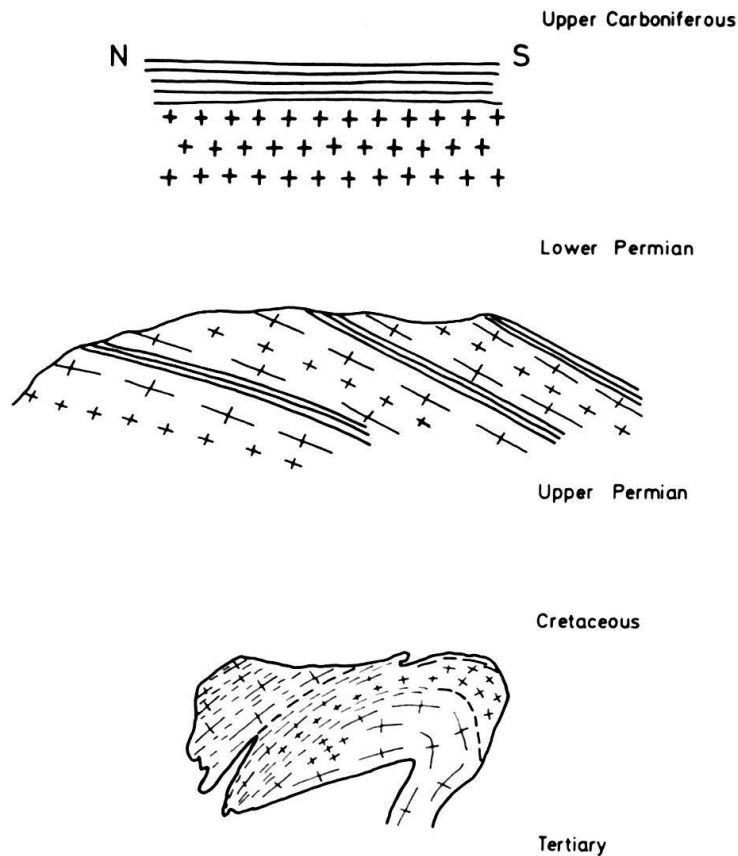

Fig. 8. Paleotectonic evolution of the Monte Rosa.

Oligocene boundary. For the Simplon region we get a different cooling pattern (see also Fig. 7). We do not think that the metamorphism occurred here 15 m.y. later than in the region of Zermatt, which is only 25 km in distance.

The supposed paleotectonic evolution of the Monte Rosa is shown in Figure 8.

After the Upper Carboniferous intrusion of the granites, a Permocarbonsiferous cover was deposited on the crystalline basement. Between Lower and Upper Permian time this sequence was affected by an orogeny and consequently by a metamorphism. The present tectonic setting was established between Lower Cretaceous and Upper Tertiary, with the main thermal phase of Alpine metamorphism occurring 38 m.y. ago.

P. BEARTH (1956) describes a postcrystalline fault zone leading northwestwards from Domodossola to the Simplon as a branch of the Insubric line (see Figs. 10, 6 and 1). Biotite age determinations from this fault zone verify the existence of an age discontinuity on either side of this zone (J. C. HUNZIKER and P. BEARTH, 1969). On the northeastern side the ages are all about 11 m.y., while on the southwestern side the ages increase normal to the fault zone from 15 to 22 m.y. over a distance of about 4 km.

The interpretation of this age jump is shown on Figure 9.

About 40 m.y. ago, the southwestern block was lifted and cooled down to about 500°C. The phengites start to record the age in the west. 32 m.y. ago the biotites in the west formed a closed system for Rb and Sr.

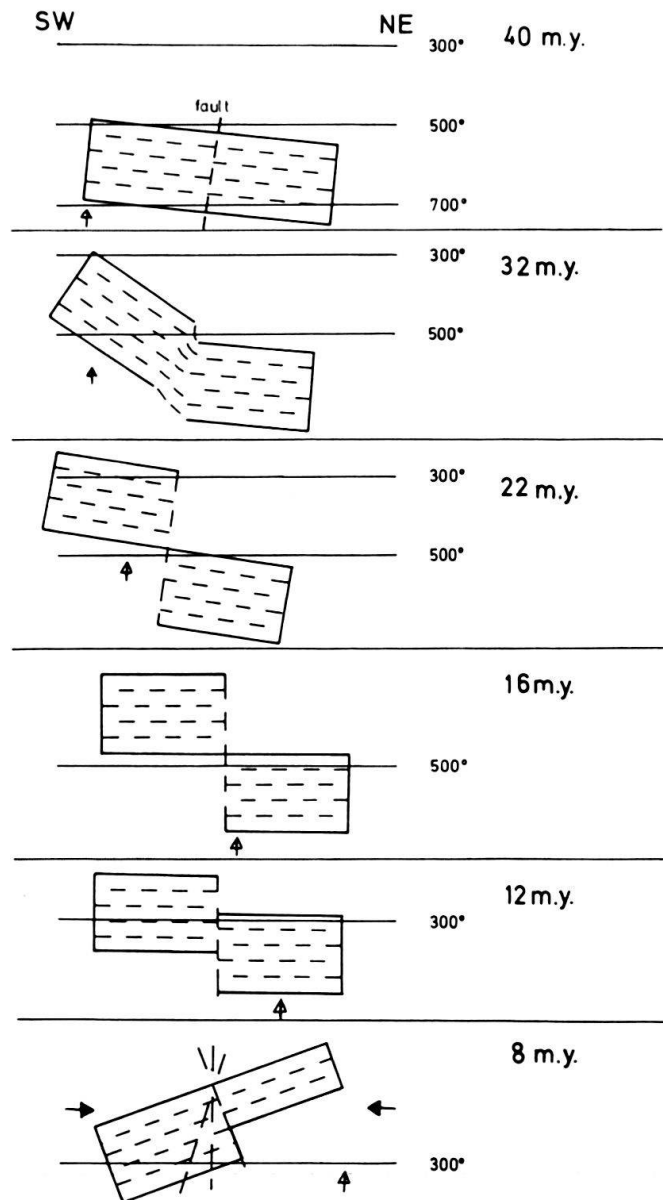

Fig. 9. Tertiary history of the Simplon fault.

Twenty-two m.y. ago, the rocks of the northeastern block cooled down to 500°C. Phengites and muscovites start counting. At this time we have the maximum displacement between northeastern and southwestern block. Assuming a geothermal gradient between 20–25°C/km and 40°C/km as S. P. CLARK and E. JÄGER (1969) do for the Simplon region, we must postulate a relative displacement of 5 to 8 km.

Sixteen m.y. ago, all the muscovites in the northeastern block formed a closed system, and 12 m.y. ago all the biotites. As a consequence, the northeastern block was lifted more strongly and reached its present position with an inclination of about 30° towards southwest. At the same time, the displacement along the fault is compensated, even overcompensated. This explains the differences in metamorphic facies described

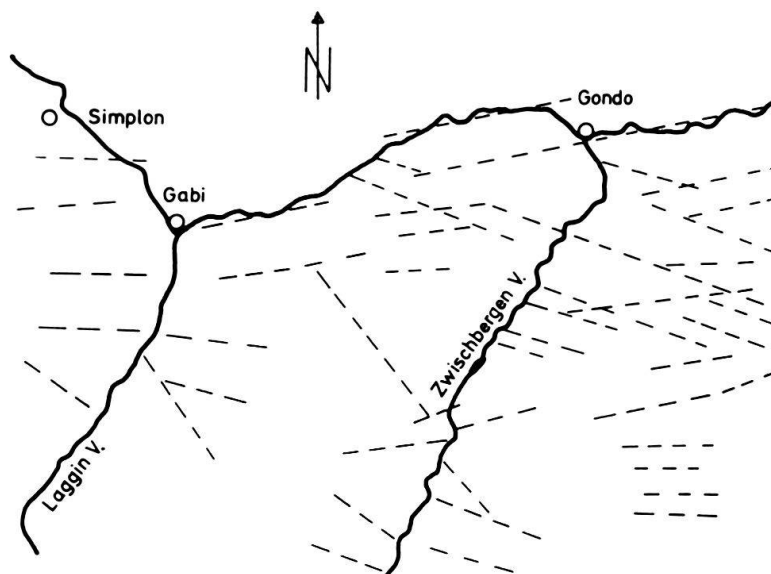

Fig. 10. Topographic sketch of the Zwischenbergen area (Simplon) showing the complicated faulting systems of the Simplon-Centovalli fault in this area. (Scale about 1 : 100000.)

by P. BEARTH (1956), and J. C. HUNZIKER and P. BEARTH (1969). The rocks on the northeastern side of the fault zone are within the amphibolite metamorphic facies, while those of the southwest are in the greenschist facies.

This event can also be correlated with the lifting of the Aaremassif. T. LABHART (1968) and A. STECK (1968), describe late Alpine displacements there of several kilometers.

Analytical data and age results

The following physical constants were used:

$\text{Sr}^{88}/\text{Sr}^{86}$ common	=	8.432 (atoms)
$\text{Sr}^{86}/\text{Sr}^{84}$	„	= 17.49
$\text{Sr}^{87}/\text{Sr}^{86}$	„	0.7091
$\text{Rb}^{85}/\text{Rb}^{87}$	„	2.591

The linear regression of the isochron was calculated using the method of least squares.

Acknowledgments

I would like to thank Prof. E. JÄGER and Prof. P. BEARTH for their great interest and help in the laboratory and in the field as well as for many stimulating discussions. I am indebted to Prof. E. NIGGLI and Prof. A. STRECKEISEN for a critical discussion of this work and to Dr. J. PURDY and R. SCHEDLER for reading the manuscript.

The assistance in the laboratory, of Dr. A. ARNOLD, Miss E. HILTBRAND, Mr. R. BRUNNER, Mr. A. EGGER and Mr. E. WENGER as well as the support of this work by the “Schweizerischer Nationalfonds zur Förderung der wissenschaftlichen Forschung” is gratefully acknowledged.

Table 1. Rb-Sr Data and Age Results on Monte Rosa Granitic Gneisses.

KAW no.	Rock Type	Locality	Rb ⁸⁷ ppm	Sr ⁸⁷ rad. ppm	Sr common ppm	Sr ⁸⁷ / Sr ⁸⁶	Rb ⁸⁷ / Sr ⁸⁶	Isochron Age
83 ^{a)}	Two-Mica, -Oligoclase-Microcline-Augengneiss	Beura, Toce Valley	55.8	0.298	147	0.7294	3.984	260 ± 10
366	Leucocrate-Biotite-Muscovite-Albitgneiss	Mattmark, Saas-Valley	88.5	0.377	44.5	0.7476	9.01	
405	Biotite-Phengite-Albite-K-Feldspar-Augengneiss	Passo Monte Moro	78.7	0.330	111	0.7396	7.279	
418	Phengite-Albitgneiss	Alpe Andolla	87.9	0.348	21.7	0.8736	41.85	
514	Fine-grained Albite microcline two Mica-gneiss	Seewjernerberg	103	0.438	47.2	0.8043	22.43	
522	Alcalifeldspar-Oligoclase-Muscovitegneiss	Mezzalama, Ayas	69.8	0.275	16.3	0.8824	43.96	

^{a)} Analysis from E. JÄGER (unpublished).

Table 2. Rb-Sr Data and Age Results on Monte Rosa Gneisses, Front Part of the Nappe.

KAW no.	Rock Type	Locality	Rb ⁸⁷ ppm	Sr ⁸⁷ rad. ppm	Sr common ppm	Sr ⁸⁷ / Sr ⁸⁶	Rb ⁸⁷ / Sr ⁸⁶	Isochron Age
367	Albite-Phengitegneiss	S. of Saas-Fee	51.4	0.142	21.5	0.7771	24.57	125 ± 20
371	Plagioclase-K-Feldspar-two-Mica-gneiss	Ponte Grande, Anzasca	57.6	0.166	32.0	0.7624	18.66	
374	K-Feldspar-Plagioclase-two-Mica-gneiss	Rottal, Saas-Valley	115	0.305	58.6	0.7628	20.18	
375	Plagioclase-two-Mica-Garnet-gneiss	Furgg-Valley	40.3	0.386	165	0.7332	2.52	
377	K-Feldspar-Albite-Augengneiss	Saas-Fee	56.1	0.428	185	0.7333	3.127	
515	Microcline-Oligoclase-two-Micagranite	Rottal, Saas-Valley	49.4	0.467	181	0.7358	2.808	
517	Aplitic-two-Mica-Alcalifeldspargneiss	Rottal, Saas-Valley	39.0	0.563	254	0.7320	1.581	

REFERENCES

- BEARTH, P. (1952a): *Geologie und Petrographie des Monte Rosa*. Beitr. Schweiz. N. F. 96.
- (1952b): *Über das Verhältnis von Metamorphose und Tektonik in der penninischen Zone der Alpen*. Schweiz. miner. petrogr. Mitt. 32.
- (1953): *Erläuterungen zu Blatt 535 Zermatt*. Geol. Atlas Schweiz. 1:25000, No. 29.
- (1956a): *Zur Geologie der Wurzelzone östlich des Ossolatales*. Eclogae geol. Helv. 49/2.
- (1956b): *Geologische Beobachtungen im Grenzgebiet der lepontinischen und penninischen Alpen*, Eclogae geol. Helv. 49/2.
- (1957): *Erläuterungen zu Blatt Saas und Monte Moro*. Geol. Atlas Schweiz, 1:25000, No. 31 und 30.
- (1958): *Über einen Wechsel der Mineralfazies in der Wurzelzone des Penninikums*. Schweiz. miner. petrogr. Mitt. 38.
- (1961): *Contributions à la Subdivision tectonique et stratigraphique du Cristallin de la Nappe du Grand St. Bernard dans le Valais, Suisse*. Livre à la Mémoire du Prof. Paul Fallot, Soc. Géol. de France.
- (1962): *Versuch einer Gliederung alpin metamorpher Serien der Westalpen*. Schweiz. Miner. Petrogr. Mitt. 42.
- (1963): *Chloritoid und Paragonit aus der Ophiolith-Zone von Zermatt-Saas-Fee*. Schweiz. miner. petrogr. Mitt. 43.
- (1964): *Erläuterungen zu Blatt Randa*, Geol. Atlas, Schweiz. 1:25000, No. 43.
- (1967): *Die Ophiolithe der Zone von Zermatt-Saas-Fee*. Beitr. geol. Karte Schweiz. N. F. 132.
- BEARTH, P., and LOMBARD, AUG. (1965): *Notices explicatives Feuille Sion*. Carte Géol. générale Suisse, 1:200000, Flle. 6.
- CLARK, S. P., and JÄGER, E. (1969): *Denudation Rate in the Alps from Geochronologic and Heat Flow Data*. Am. J. Sci. 267.
- HANSON, G. N., GRÜNENFELDER, M., SOPTRAYANOVA, G. (1969): *The Geochronology of a Recrystallized Tectonite in Switzerland – The Roffna-Gneiss*. Earth and Planetary Sci. Lett. 5.
- HARLAND, W. B., SMITH, A. G., and WILCOCK, B. (1964): *The Phanerozoic Time Scale*. Holmes Symposium. Geol. Soc. London.
- HUNZIKER, J. C., and BEARTH, P. (1969): *Rb-Sr-Altersbestimmungen aus den Walliser Alpen, Biotit-alterswerte und ihre Bedeutung für die Abkühlungsgeschichte der alpinen Metamorphose*. Eclogae geol. Helv. Vol. 62/1.
- HUNZIKER, J. C. (1969): *Rb-Sr-Altersbestimmungen aus den Walliser Alpen Hellglimmer- und Gesamtgesteinsalterswerte*. Eclogae geol. Helv. Vol. 62/2.
- JÄGER, E., NIGGLI, E., and WENK, E. (1967): *Rb-Sr-Altersbestimmungen an Glimmern der Zentralalpen*. Beitr. geol. Karte Schweiz, N.F. 134.
- LABHART, T. (1968): *Der Bau des nördlichen Aarmassivs und seine Bedeutung für die alpine Formungsgeschichte des Massivraumes*. Schweiz. miner. petrogr. Mitt. 48/2.
- NIGGLI, E., and NIGGLI, C. R. (1965): *Karten der Verbreitung einiger Mineralien der alpidischen Metamorphose in den Schweizer Alpen (Stilpnomelan, Alkali-Amphibol, Chloritoid, Staurolith, Disthen, Sillimanit)*. Eclogae Geol. Helv. 58/1.
- TROMMSDORFF, V. (1966): *Progressive Metamorphose kieseliger Karbonatgesteine in den Zentralalpen zwischen Bernina und Simplon*. Schweiz. min. petrogr. Mitt. 46/2.
- STECK, A. (1968): *Die alpidischen Strukturen in den Zentralen Aaregraniten des westlichen Aarmassivs*. Eclogae geol. Helv. 61/1.
- VELDE, B. (1965): *Phengite Micas: Synthesis, Stability and Natural Occurrence*. Amer. J. Sci. 263.
- VELDE, B., and KORNPORST, J. (1969): *Stabilité des silicates d'alumines hydratés*. Contr. Mineral. and Pétrol. 21, 63–74.
- ZWART, H. J. (1967): *Orogenesis and Metamorphic Fazies Series in Europa*. Meddelelser fra Dansk Geologisk Forening Bd. 17, Heft 4.

