

**Zeitschrift:** Eclogae Geologicae Helvetiae  
**Herausgeber:** Schweizerische Geologische Gesellschaft  
**Band:** 94 (2001)  
**Heft:** 3

**Artikel:** Osteology and phylogenetic relationships of the teleost *Goulmimichthys arambourgi* Cavin, 1995, from the Upper Cretaceous of Goulmima, Morocco  
**Autor:** Cavin, Lionel  
**DOI:** <https://doi.org/10.5169/seals-168909>

### **Nutzungsbedingungen**

Die ETH-Bibliothek ist die Anbieterin der digitalisierten Zeitschriften. Sie besitzt keine Urheberrechte an den Zeitschriften und ist nicht verantwortlich für deren Inhalte. Die Rechte liegen in der Regel bei den Herausgebern beziehungsweise den externen Rechteinhabern. [Siehe Rechtliche Hinweise.](#)

### **Conditions d'utilisation**

L'ETH Library est le fournisseur des revues numérisées. Elle ne détient aucun droit d'auteur sur les revues et n'est pas responsable de leur contenu. En règle générale, les droits sont détenus par les éditeurs ou les détenteurs de droits externes. [Voir Informations légales.](#)

### **Terms of use**

The ETH Library is the provider of the digitised journals. It does not own any copyrights to the journals and is not responsible for their content. The rights usually lie with the publishers or the external rights holders. [See Legal notice.](#)

**Download PDF:** 16.03.2025

**ETH-Bibliothek Zürich, E-Periodica, <https://www.e-periodica.ch>**

# Osteology and phylogenetic relationships of the teleost *Goulmimichthys arambourgi* Cavin, 1995, from the Upper Cretaceous of Goulmima, Morocco

LIONEL CAVIN

*Key words:* Morocco, Cretaceous, osteology, Pachyrhizodontidae, phylogenetic relationships

## RESUME

L'ostéologie du téléostéen crétacé *Goulmimichthys arambourgi* est décrite et ses relations phylogénétiques sont discutées. Son inclusion au sein de la famille des Pachyrhizodontidae et du sous-ordre des Pachyrhizodontoidei est démontrée grâce à une analyse cladistique. La robustesse de l'analyse cladistique est testée en modifiant expérimentalement la matrice de données. Des caractères diagnostiques pour les Protobramoidei nov., les Pachyrhizodontoidei, les Notelopidae et les Pachyrhizodontidae sont proposés. Les Pachyrhizodontidae constituent une famille marine de poissons prédateurs qui a disparu probablement à la limite Crétacé-Tertiaire.

## ABSTRACT

The osteology of the Cretaceous teleost *Goulmimichthys arambourgi* is described, and its phylogenetic relationships are discussed. According to a cladistic analysis, this species is included in the family Pachyrhizodontidae and in the sub-order Pachyrhizodontoidei. The robustness of the cladistic analysis is tested by experimental analysis of the data set. Diagnostic characters are proposed for the Protobramoidei nov., the Pachyrhizodontoidei, the Notelopidae and the Pachyrhizodontidae. Pachyrhizodontids were marine ichthyvorous fishes, which probably became extinct at the Cretaceous-Tertiary boundary.

## Contents

1. Introduction .....	509	Axial skeleton .....	518
2. Abbreviations used in the figures .....	510	Caudal skeleton .....	518
3. Systematic paleontology .....	511	Squamation .....	519
3.1 Material .....	511	4. Phylogenetic relationships .....	519
3.2 Description .....	512	4.1 Historical review .....	520
Braincase .....	513	4.2 Species included in the analysis .....	521
Upper jaw .....	515	4.3 Character analysis .....	522
Lower jaw .....	516	4.4 Phylogenetic analysis .....	527
Circumorbital series .....	516	Experimental analysis of the data set .....	528
Hypopalatine and gill arches .....	516	Results .....	529
Opercular series .....	517	4.5 Discussion .....	532
Pectoral girdle and fin .....	517	5. Conclusion .....	533
Pelvic girdle and fin .....	517	References .....	534
Dorsal fin .....	518		

## 1. Introduction

*Goulmimichthys arambourgi* Cavin, 1995 is the first teleost described from the locality of Goulmima, after the name of a city on the southern slope of the Moroccan Atlas. The town of Goulmima is bordered by a palm grove watered by the oued Rheris coming down the high summits of the Atlas chain, then flowing out to the Southern margin of the Tafilalt basin. To

the north of Goulmima, the oued Rheris flows out across southwest-northeast oriented chains of moderately high mountains (*circa* 1500 m above sea level) overlaid by a calcareous plateau. The fossiliferous deposits occur at the base of this plateau and are exposed on the sides of the Rheris valley and small tributaries, as well as just below the top of the cliff overhanging the plain situated between Goulmima and Errachidia.

GIS PalSédCo (Toulouse-Espéraza), Musée des dinosaures, 11260 Espéraza-France. E-mail: lionel.cavin@dinosauria.org

The lithological unit is formed by a Cenomanian-Turonian sequence laying on a 40 m thick unit of gypsiferous marl. The fossils are generally contained in early diagenetic calcareous nodules lying horizontally in marly limestone, in association with the Lower Turonian ammonite *Mammites*. A short description of the nodules and a simplified stratigraphical log based on exposures in a cliff *circa* 2 km east of Tadirhoust, about 20 kilometres to the North of Goulmima, are given in Cavin (1999). The precise origins of the fossils described herein are unknown but fieldtrips have revealed that several localities situated near the villages of Tadirhoust and Asfla, provide most of the fossils. The fossiliferous nodules are exploited by local people in small excavations. They have been mentioned by Dubar (1949, p. 39) in his explanations of the geological map of the High Atlas from the Midelt area: “*Turonien. Calcaire blanchâtre, marneux, tendre, avec bancs ou lits de “pains calcaire”, souvent avec des silex (6 à 12 m.); des lits de lumachelles de petits lamellibranches ou Gastropodes s’intercalent parfois vers leur base. Certaines couches de “pains calcaires” renferment une faune d’Ammonites turoniennes : Mammites sp., Hoplitoides mirabilis Perv., Pseudotissotia sp., Vasoceras sp., Fagesia Peroni Perv., etc... avec débris de poissons*”.

Systematic excavations on the fossiliferous localities have not yet been carried out. However, we have information about the composition of the vertebrate assemblage and the relative abundance of different forms according to fieldtrips and observations of private collections kept by local people. *Goulmimichthys arambourgi* seems to be the most abundant vertebrate preserved in the nodules. Another common fish is the ichthyodectiform *Ichthyodectes bardacki* Cavin, 1997, whose specimens are often preserved in nodules displaying the shape of the fish they contained. Rarer are the osmoroidid *Osmoroides rheris* Cavin, 1997 and the araripichthyid *Araripichthys corythophorus* Cavin, 1997. Enchodontids and rare pycnodontids generally appear as microremains in gut contents of larger forms. A few minute teeth of a sclerorhynchid shark have been recovered from the matrix of nodule during acid preparation. Until now, the marine reptile assemblage is comprised of remains of plesiosaurs, pliosaurs, polycotyliids, varanoids lizards and rare marine turtles (Bardet, personal communication, 1999).

Most of the specimens used in this study were prepared using 10 per cent. formic acid. Some were mechanically prepared using an air pressure hammer.

## 2. Abbreviations used in the figures

a.f.n.a	process for articulation with the first neural arch
a.f.p	articular facet for the palatine
a.f.r	articular facet for the radials
al.tr	alimentary tract
An-Ar	angulo-articular
ant.op.j.c	anterior opening of the jugular canal
ant.pro	anterior process
Apal	autopalatine
As	autosphenotic
Boc	basioccipital

Br.r	branchiostegal ray
Ch.ant	anterior ceratohyal
Ch.post	posterior ceratohyal
Cl	cleithrum
Cor	coracoid
c.r	caudal ray
D	dentary
df	dilatator fossa
Dpal	dermopalatine
Dsp	dermosphenotic
Ecpt	ectopterygoid
Enpt	entopterygoid
Epo	epioccipital
Exo	exoccipital
fa.hm	hyomandibular facet
f.by	foramen for the buccohypophyseal canal
f.fa	foramen facial
f.hy.VII	foramen for the hyomandibular trunk of the facial nerve
f.i.c	foramen for the internal carotid artery
fl.Pts	flange on the pterosphenoid
f.m	foramen magnum
f.m.c.v	foramen for the middle cerebral vein
f.o.a	foramen for the orbital artery
f.oph.V.VII	foramen for the superficial ophtalmic branches of the facial and trigeminal nerves
f.ot.VII	foramen for the otic branch of the facial nerve
f.pal.V	foramen for the palatine branch of the trigeminal nerve
f.pt	foramen
Fr	frontal
f.tr	foramen trigeminal
f.I	foramen for the olfactory nerve
f.III	foramen for the oculomotor nerve
f.IX	foramen for the glossopharyngeal nerve
f.X	foramen for the vagus nerve
g.cont	gut content
h	hypural
hs.Pu	hemal spine of preural vertebra
Hy	hyomandibular
hyph	hypurapophysis
Ic	intercalar
il.re	iliac region
Io	infraorbital
Iop	interoperculum
is.re	ischial region
Le	lateral ethmoid
Mcor	mesocoracoid
Mpt	metapterygoid
Mx	maxilla
mx.pr	maxillary process
my.post	posterior myodome
na.Pu	neural arch of preural vertebra
n.IV	notch for the trochlear nerve
Op	operculum
op.pr	opercular process
Ors	orbitosphenoid
Pa	parietal
Par	parasphenoid
pelv.b	pelvic bone
pelv.f	pelvic fin
Ph	parhypural
Pop	preoperculum
post.op.j.c	posterior opening for the jugular canal
pr.br	prootic bridge
p.re	pubic region
Pro	prootic
pt.fo	posttemporal fossa
Pto	pterotic
Pts	pterosphenoid

Pu	preural vertebra
Q	quadrate
Sc	scapula
Smx	supramaxilla
So	supraorbital
Soc	supraoccipital
Sop	suboperculum
S.ri	sclerotic ring
Stt	supratemporal
Sy	symplectic
T	tooth
Un	uroneural
V	vertebra
Vo	vomer

### 3. Systematic paleontology

Suborder Pachyrhizodontoidei Forey, 1977

Family Pachyrhizodontidae Cope, 1872

Genus *Goulmimichthys* Cavin, 1995

#### Emended diagnosis

Pachyrhizodontid fish in which a well developed supraoccipital crest extends posteriorly to the braincase; pterotics produced as posteriorly directed spines; epioccipitals produced as posteriorly blunt process; exoccipitals do not reach ventrally the paras-

phenoid; exoccipitals meeting above and below the foramen magnum; parasphenoid with two shallow lateral wings at its anterior extremity; vomer bears anteriorly a patch of minute teeth; five free infraorbitals; entopterygoids with a patch of minute pointed teeth; palatine with a broad maxillary process; preoperculum with a wide and truncated dorsal limb; pelvic bone with a thin and elongated anterior process and with a well developed lateral iliac process; fin-ray counts, P. 15, V. 13.  
Type species: *Goulmimichthys arambourgi* Cavin, 1995

*Goulmimichthys arambourgi* Cavin, 1995

Emended diagnosis: as for genus, only species.

#### 3.1 Material

The specimens mentioned in this study are kept in the Natural History Museum of Boulogne-sur-mer (BHN), France.

*Holotype*: BHN 2 P 2, an acid-prepared specimen. It comprises the head without the anterior extremity of the snout, the ventral part of the trunk, the pectoral and pelvic girdles and the proximal extremities of the paired fins. Unpaired fins are not preserved. A fragment of the alimentary tract with gut content is preserved (Fig. 1).

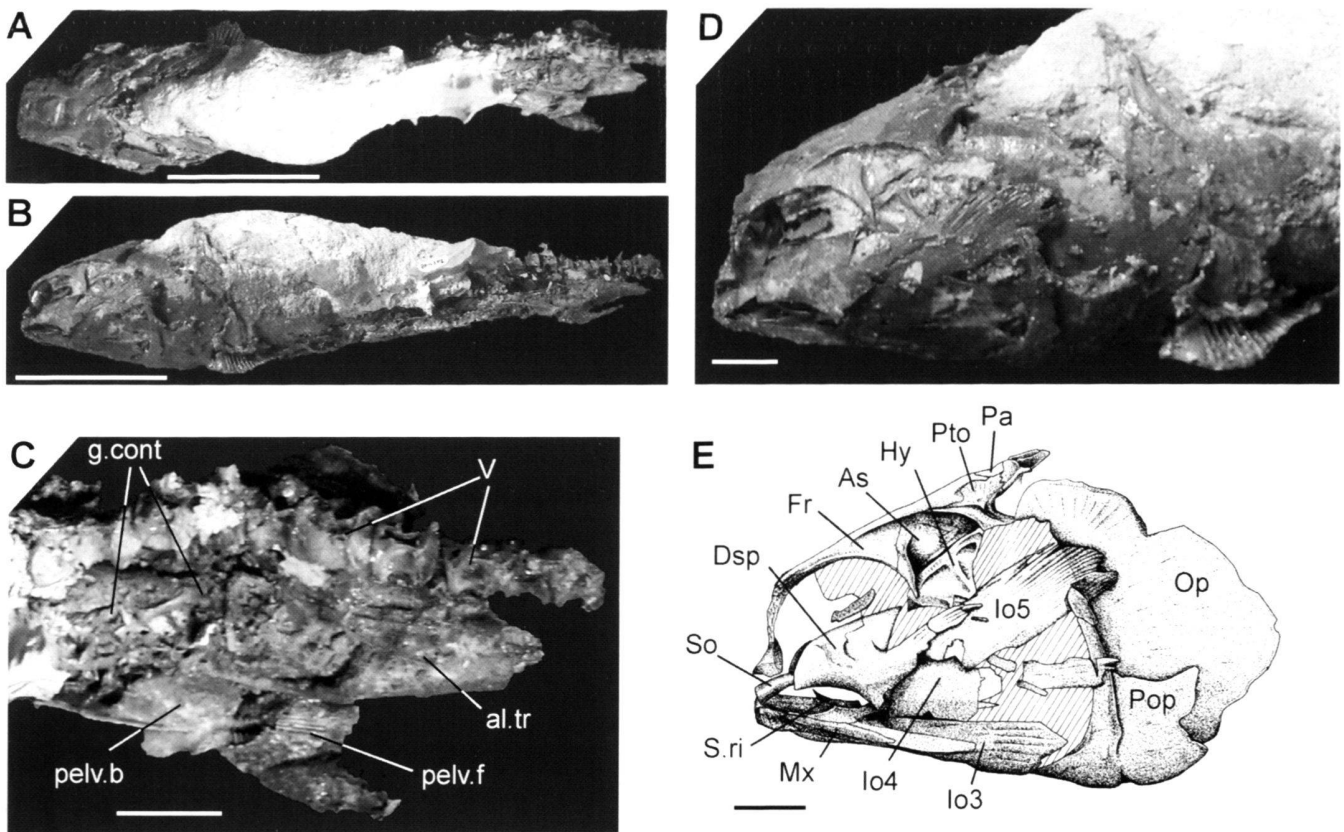

Fig. 1. *Goulmimichthys arambourgi*, holotype (BHN 2P2). A: photograph in dorsal view. Scale bar: 50 mm. B: photograph in lateral view. Scale bar: 50 mm. C: detail of the pelvic region in dorsal view. Scale bar: 10 mm. D: detail of the head in lateral view. Scale bar: 10 mm. E: drawing of the head in lateral view. Scale bar: 10 mm.

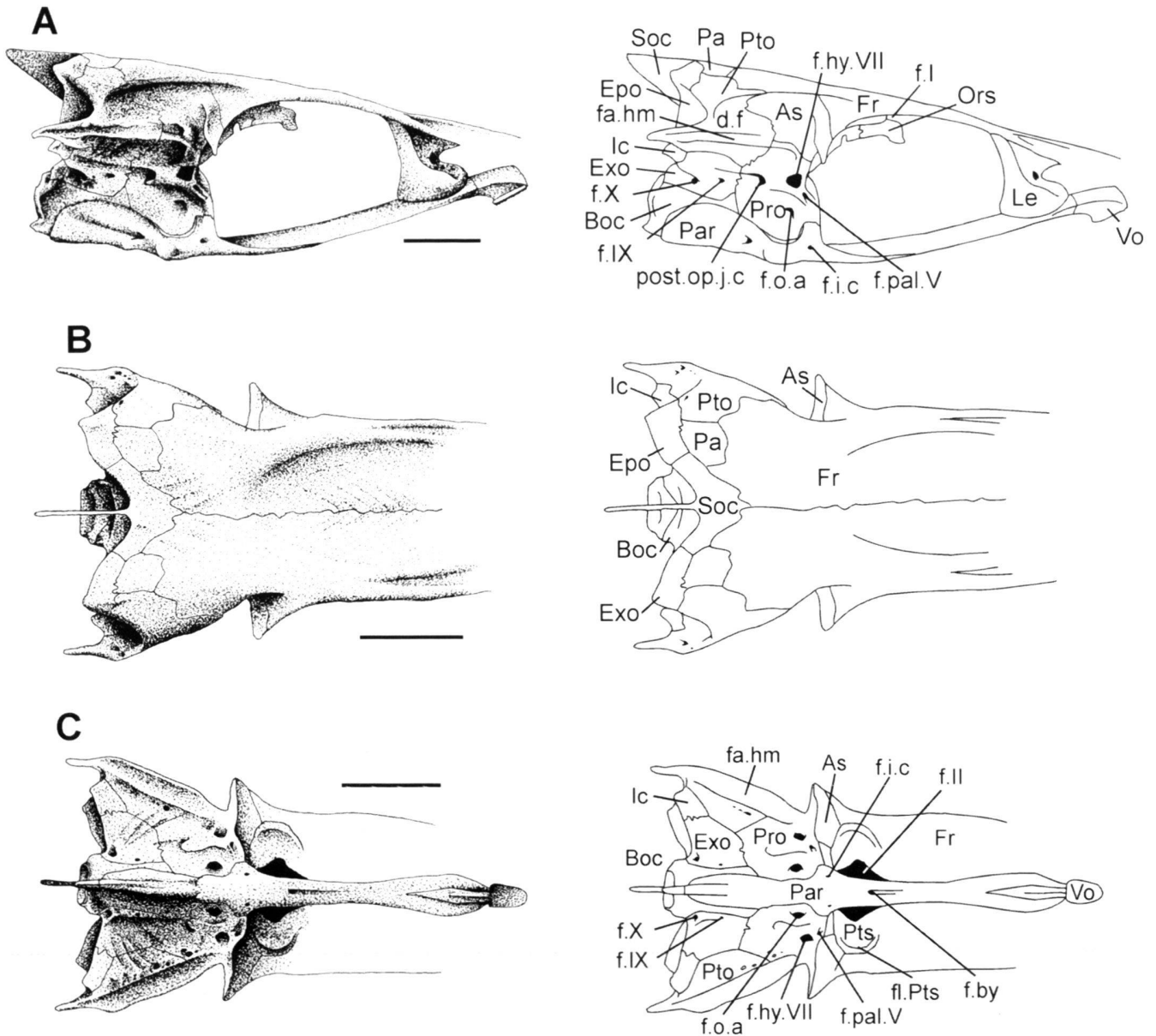

Fig. 2. *Goulmimichthys arambourgi*, reconstruction and diagrammatic drawings of the braincase in lateral (A), dorsal (B) and ventral (C) views. Scale bars: 10 mm.

Acid-prepared specimens: BHN 2 P 3 (partial skeleton without the head and with the caudal skeleton [detached during preparation]); skull of a juvenile *Enchodus* sp. in the alimentary tract [Cavin 1999]; BHN 2 P 4 (skull and pectoral girdle); BHN 2 P 5 (skull and pectoral girdle); BHN 2 P 6 (skull and pectoral girdle); BHN 2 P 7 (partial skeleton); BHN 2 P 8 (partial skeleton); BHN 2 P 9 (disarticulated elements); BHN 2 P 10 (partial skeleton and disarticulated elements); BHN 2 P 11 (partial skeleton); BHN 2 P 12 (partial skeleton); BHN 2 P 13 (partial skeleton); BHN 2 P 14 (partial skeleton); BHN 2 P 15 (partial skeleton); BHN 2 P 16 (skull and pectoral girdle); BHN 2 P 17 (skull and pectoral girdle); BHN 2 P 18 (partial skeleton and disarticulated elements).

Mechanically-prepared specimens: BHN 2 P 19 (part of the trunk); BHN 2 P 20 (part of the trunk); BHN 2 P 21 (part of the trunk); BHN 2 P 22 (part of the trunk); BHN 2 P 23 (part of the trunk); BHN 2 P 24 (part of the trunk); BHN 2 P 25 1 and 2 (part of the trunk).

### 3.2 Description

None of the available specimens are complete because anterior and posterior extremities of the bodies are generally not included in the nodules (a single caudal skeleton has been recovered). The standard length may be estimated to 300 mm. The maximum height of the body is contained about five times in its maximum length.

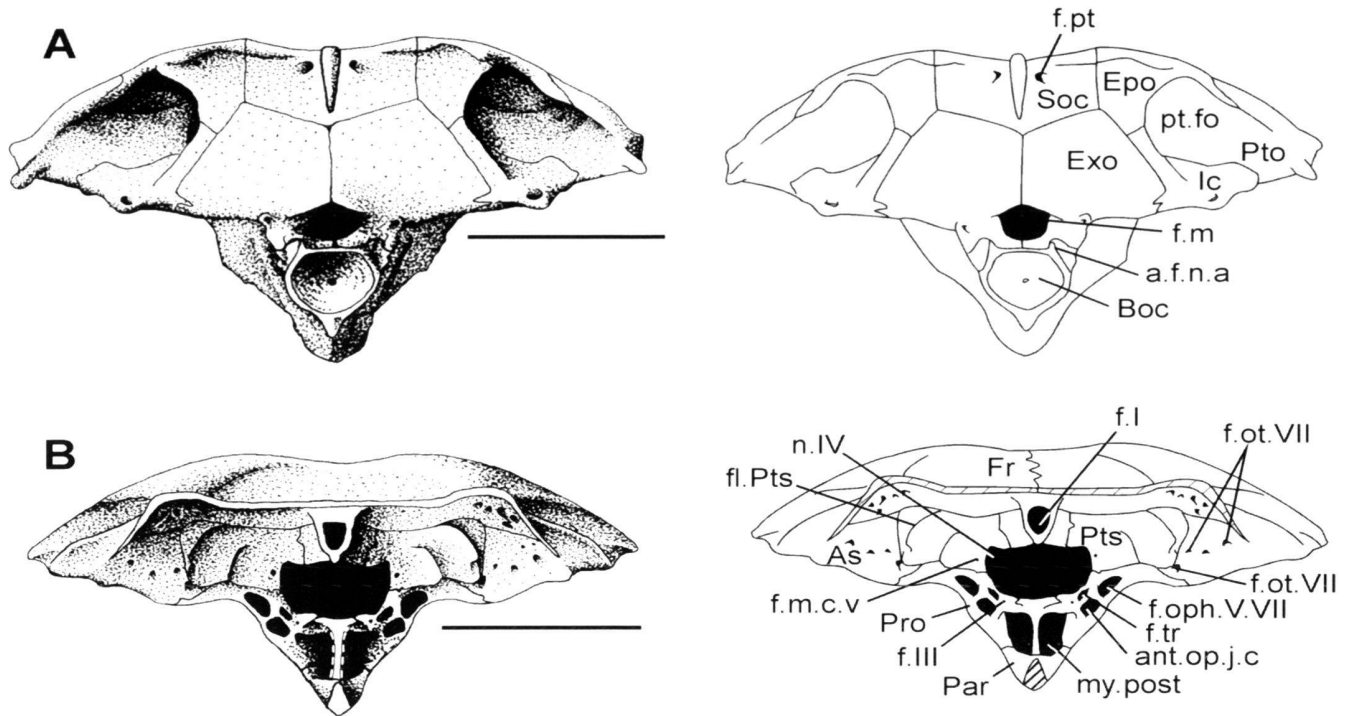

Fig. 3. *Goulmimichthys arambourgi*, reconstruction and diagrammatic drawings in posterior (A) and orbital (section at the level of the orbit) (B) views of the posterior part of the braincase. Scale bars: 10 mm.

#### Braincase (Figs. 2 and 3)

The lateral margin of the frontal (Fr) is concave above the spine of the autosphenotic (As) in dorsal view (Fig. 2B). A lamina of the frontal extends ventroposteriorly from the posterior edge of the frontal to reach the spine of the autosphenotic. Such a participation of the frontal to the anterior part of the lateral expansion of the autosphenotic is not present in *Rhacolepis buccalis*. A broad and shallow median depression is dug on the posterior part of the frontals of *Goulmimichthys arambourgi* as in most other pachyrhizodontids.

The Pterotic (Pto) is produced as a well-developed posterolaterally directed spine. The maximum width of the skull roof occurs at the level of the posterior tips of the pterotics. The pterotic forms the lateral wall and the posterior part of the floor of the posttemporal fossa (pt.fo), and the posterior half of the hyomandibular facet (fa.hm). The otic sensory canal runs on the margin of the pterotic, overlying the dilatator fossa (d.f). The exit of the otic sensory canal opens lateral to the posttemporal fossa, near the base of the pterotic spine.

The parietal (Pa) is small and separate from its fellow by the supraoccipital (Soc).

A well developed supraoccipital crest extends posteriorly to the braincase, but it does not form ventrally a *spina occipitalis*. Two foramens (f.pt) open on the posterior face of the supraoccipital, on each side of the base of the crest. They are probably the exits of canals reaching the posttemporal fossa as described in *Pachyrhizodus megalops* (Forey 1977), *Rha-*

*colepis* and *Notelops* (Maisey 1991a). The dorsal margin of the supraoccipital is slightly concave in posterior view (Fig. 3A).

The epioccipital (Epo) is produced as a well-developed blunt posterior process. It forms the medial wall of the posttemporal fossa. The floor of the posttemporal fossa shows a gap between the pterotic and epioccipital, which marks the posterior part of the sacculo-lagenar chamber.

A transverse section through the otic region of the braincase shows a moderate convex dorsal margin, intermediate between the very convex skull roof of *Pachyrhizodus* and the flat skull roof of *Rhacolepis* (Forey 1977).

The intercalar (Ic) forms the posteromedial floor of the posttemporal fossa. There is no prootic-intercalar bridge. The intercalar bears a small dorsal process, on which rests a shallow depression for the articulation of the intercalar branch of the posttemporal. The intercalar forms the ventral margin of the posttemporal fossa and interdigitates with the exoccipital.

Most of the posterior wall of the braincase is formed by the exoccipital (Exo). The foramen magnum (f.m) is entirely enclosed between the two exoccipitals as in *Notelops*. In *Pachyrhizodus* and *Rhacolepis* the ventral margin of the foramen magnum is formed by the basioccipital (Forey 1977). A large foramen for the exit of the vagus nerve (f.X) is situated below a ridge running on the lateral face of the exoccipital and reaching the intercalar posteriorly. A smaller foramen for the exit of the glossopharyngeal nerve (f.IX) opens more anteriorly on the lateral face of the exoccipital. Laterally, the ventral margin of the exoccipital meets the basioccipital (Boc) as in

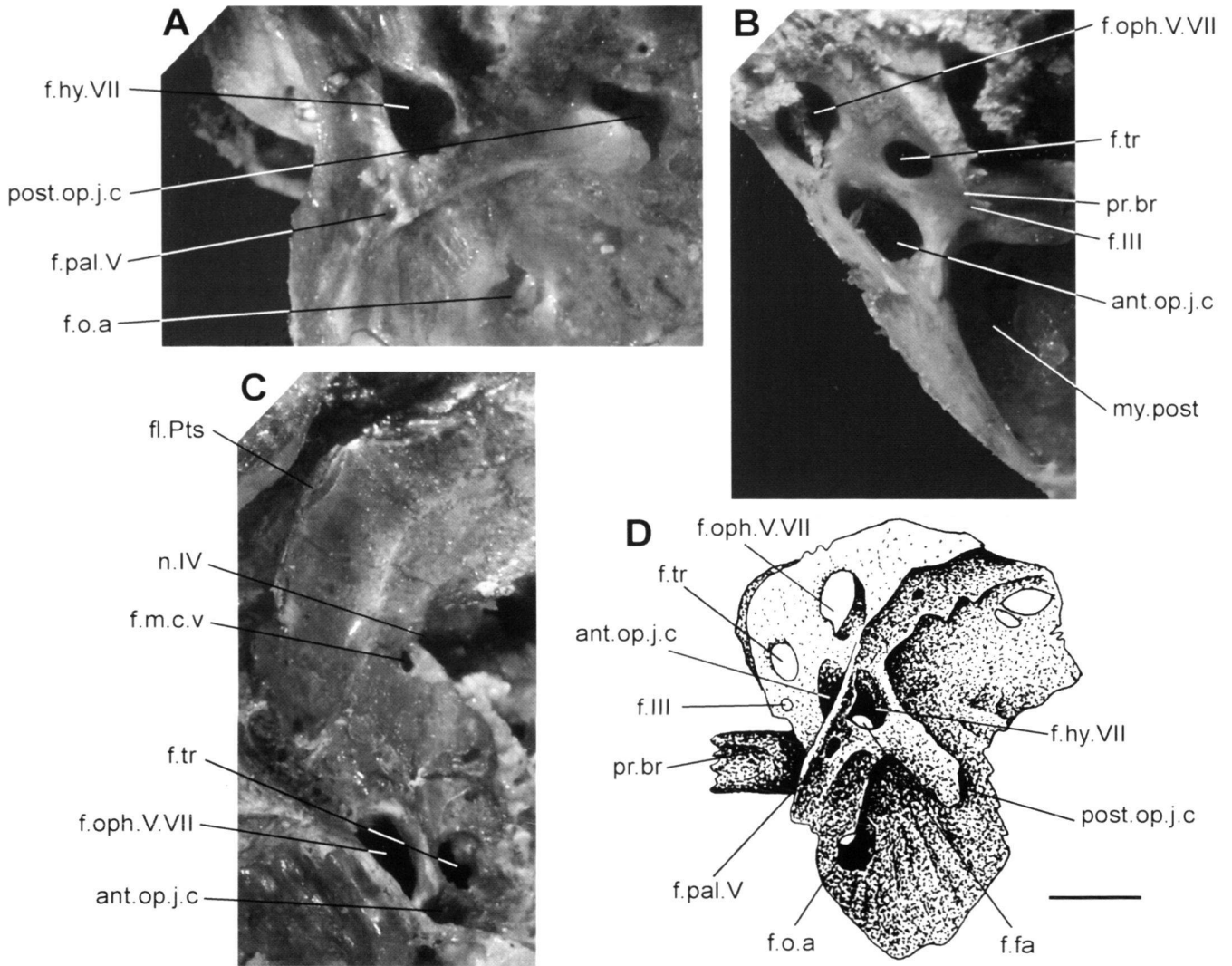

Fig. 4. *Goulmimichthys arambourgi*, photographs of the prootic in lateral (A), anterior (B), anteroventral (C) views and reconstruction of the prootic in antero-lateroventral view (D). Scale bar: 2 mm.

*Notelops*, and not the parasphenoid (Par) as in *P. megalops* and *Rhacolepis* (Fig. 2A).

The basioccipital forms the occipital condyle. It bears two small processes situated on each side of the foramen magnum, probably for the articulation of the first neural arch (a.f.n.a). Forey (1977) suggested that these pits, present in *Pachyrhizodus megalops* and *Rhacolepis* but not in *Notelops*, indicate that a centrum element has been incorporated into the basioccipital. On the lateral face, the basioccipital extends anteriorly between the exoccipital and the parasphenoid and meets anteriorly the prootic on the contrary of *Rhacolepis*. *Goulmimichthys arambourgi* has no subtemporal fossa.

The structure of the *trigemino-facialis* chamber is as follows (Fig. 4): the posterior exit of the jugular vein (post.op.j.c) is situated posteriorly on the lateral face of the prootic, close to the suture with the exoccipital. This position is primitive for

teleosts and reminiscent of elopids (Patterson 1964; Taverne 1974). The jugular canal runs along the lateral face of the prootic and is pierced anterodorsally by a large foramen for the exit of the hyomandibular trunk of the facial (f.hy.VII). The hyomandibular trunk crossed the medial wall of the *pars jugularis* by the facial foramen (f.fa) and reached the *pars ganglionaris* in the brain cavity. Laterally, a second canal extends ventrally from the jugular canal and opens near the ventral margin of the prootic: it accommodated the orbital artery (f.o.a). An other small foramen opens below the foramen for the hyomandibular trunk of the facial: it probably accommodated the palatine branch of the trigeminal nerve (f.pal.V). This nerve then ran down in a groove on the lateral face of the prootic. The jugular canal opens through a large foramen on the orbital face of the prootic (ant.op.j.c). Three others foramina open dorsally and medially to the anterior opening of the

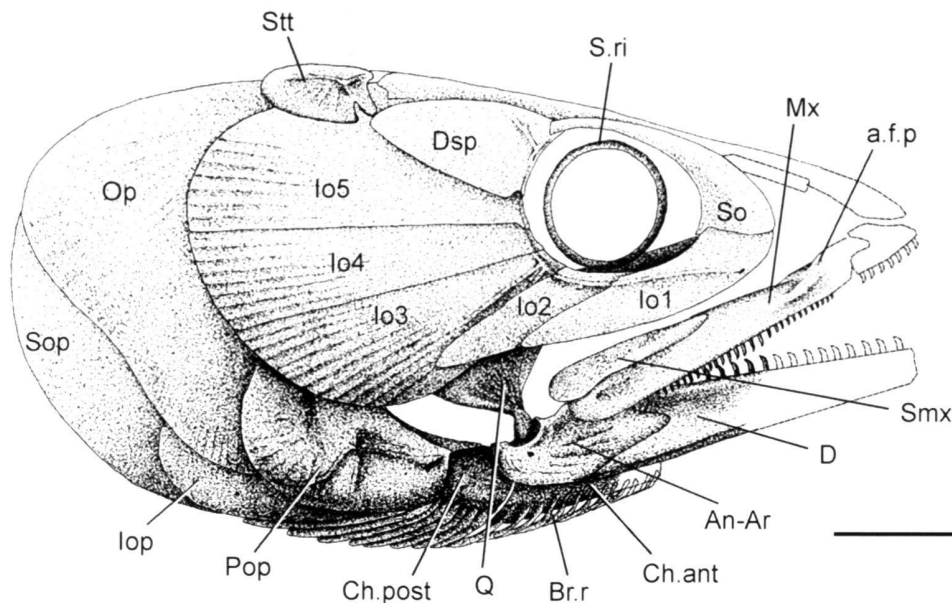

Fig. 5. *Goulmimichthys arambourgi*, reconstruction of the head in lateral view. Scale bar: 10 mm.

jugular canal. The smallest one is situated medially near the prootic bridge (pr.br) and accommodated the oculomotor nerve (f.III). The other two lead to the *pars ganglionaris*. From these two foramens, the medial one is the trigeminal foramen (f.tr), which accommodated the trigeminal nerve (V), the buccal branch of the facial (VII) and possibly the *profundus* nerve, and the dorsolateral one (f.oph.V.VII) accommodated the superficial ophthalmic branches of the facial (VII) and perhaps of the trigeminal (V) nerves. The axis of the latter foramen shows that the ophthalmic branches probably ran dorsally of the prootic then ran along a flange on the pterosphenoid (fl.Pts, Figs. 3B and 4). Forey (1977) described an almost similar structure in *Rhacolepis* and in *Pachyrhizodus megalops*. The palatine branch of the facial nerve entered into the myodome by a small foramen below the prootic bridge.

The autosphenotic (As) is produced laterally as a prominent spine. It forms the anterior half of the hyomandibular facet. A large foramen on the orbital face of the autosphenotic, close to the suture with the pterosphenoid, may be homologized with the opening for the exit of the otic branches of the facial nerve (f.ot.VII) described in *P. megalops* (Forey 1977).

The pterosphenoid (Pts) forms the lateral margin of the large optic foramen. A notch on each side of this foramen accommodated the trochlear nerves (n.IV). There is a small foramen situated laterally to the notch for the middle cerebral vein (f.m.c.v) as in *Pachyrhizodus megalops* (Forey 1977).

The orbitosphenoid (Ors) meets posteriorly the pterosphenoid and dorsally the frontal. Its anteroventral extremity shows a small process. The orbitosphenoid encloses the foramen for the olfactory nerve (f.I).

The basisphenoid is unknown.

The lateral ethmoid (Le) is well developed. It forms a large capsule, which opens anteriorly, and rests (but not fuses)

above the parasphenoid medially and entopterygoid laterally.

The anterior part of the vomer (Vo) forms a plateau located below the level of the parasphenoid and bearing numerous minute teeth. It differs from the one of *Rhacolepis*, which has a vomer without an anterior thrust and bearing two pointed teeth (Forey 1977), and from the one of *Elopopsis microdon*, which has an edentulous vomer without an anterior thrust (Taverne 1993), but looks like the vomer of *Elops lacerta* (Taverne 1974). The posterior part of the vomer forms an elongated spine lying under the anterior extremity of the parasphenoid.

In lateral view, the parasphenoid (Par) forms an angle in the otic region, which is weaker than the one described in *Rhacolepis* and *Pachyrhizodus megalops*. The median buccohypophyseal canal (f.by) opens on the ventral face of the parasphenoid at the level of the posterior two-thirds of the orbit and continues anteriorly by a shallow groove. The ascending wing is more developed than in *Rhacolepis buccalis*. The foramen for the internal carotid artery (f.i.c) opens ventrally to the ascending wing. As in *R. buccalis*, a shallow prominence for the articulation for the first infrapharyngobranchial is situated posteriorly to the foramen of the carotid. There is apparently no posterior opening of the posterior myodome. The parasphenoid shows anteriorly a pair of shallow lateral wings on which rest the lateral ethmoids. This structure is not described in other pachyrhizodontids.

#### Upper jaw (Fig. 5)

The premaxilla is unknown.

The maxilla is elongate and has a straight oral margin. Its anterior extremity is not known. The articular facet for the palatine (a.f.p) is well-developed and continues posteriorly with a low



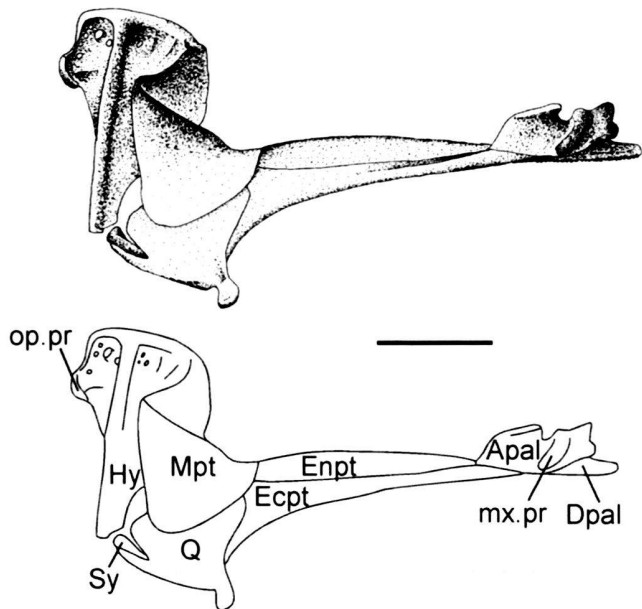

Fig. 6. *Goulmimichthys arambourgi*, reconstruction and diagrammatic drawing of the suspensorium in lateral view. Scale bar: 10 mm.

crest as in *Rhacolepis* (Forey 1977). The dorsal margin is slightly convex. The estimated number of maxillary teeth is about 35. They are slightly internally recurved and set in a single row. The anterior most ones are small and close together, then the subsequent ones are taller and more spaced out. The tallest teeth on a maxilla of about 25 mm in length are 1 mm in height (BHN 2P15). A narrow edge of bone lies lateral to the oral margin as in *Notelops*, *Rhacolepis* and *Pachyrhizodus megalops* (Forey 1977).

One supramaxilla (Smx) is present. Its anterior extremity is thin and sharp, and its posterior rounded extremity is situated above the maxilla, but does not form the posterior extremity of the upper jaw as previously described (Cavin 1995).

#### Lower jaw (Fig. 5)

The quadrate-mandibular articulation is situated posterior to the level of the orbit (on the Fig. 5, the joint of the lower jaw is below the posterior part of the orbit because the specimen is illustrated with the mouth slightly open and the quadrate shifted anteriorly). The coronoid process is weakly developed.

The dentary (D) is the largest bone of the lower jaw. It bears a single row of slightly posteromedially recurved teeth. Their count is unknown and they are slightly larger than the maxillary teeth.

The angulo-articular (An-Ar) forms a well-developed postarticular process. Its posteroventral region is ornamented with ridges as in *Rhacolepis* (Forey 1977).

The retroarticular is unknown. A depression on the medial face of the angulo-articular below the articular facet is visible

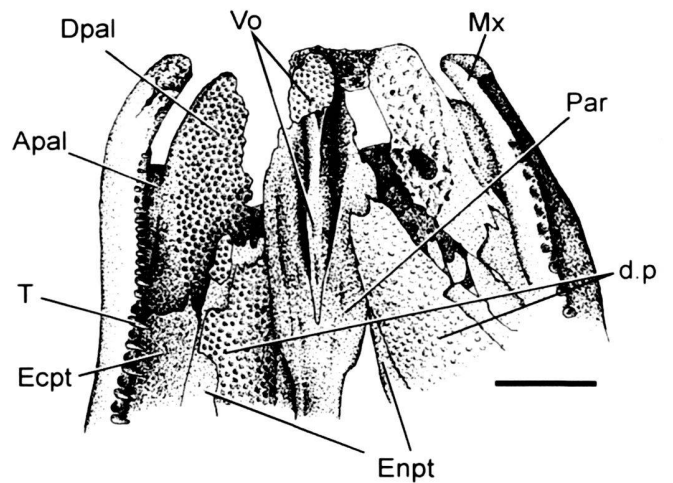

Fig. 7. *Goulmimichthys arambourgi* (BHN 2P15), anterior extremity of the snout region in ventral view. Scale bar: 2 mm.

on BHN 2P10: it suggests that the retroarticular was present. Forey (1977) pointed out that the retroarticular of *Rhacolepis* is small and often dissociated in acid-prepared specimens. The retroarticular of *Goulmimichthys arambourgi* was probably excluded from the joint facet for the quadrate.

The mandibular sensory canal opens on the lateral face of the angulo-articular by two pores and not three as in *Rhacolepis*.

#### Circumorbital series (Figs. 1D, E and 5)

The supraorbital (So) is narrow posteriorly and enlarged anteriorly where it meets the first infraorbital (Io1).

The first infraorbital ends posteriorly in a spine. Its dorsal margin is concave and forms the anteroventral border of the orbit. The second infraorbital is smaller than the first one and its posterior extremity is spiny and overlaps the third infraorbital. The three subsequent infraorbitals are very well-developed posteriorly and cover the whole length of the ascending arm of the preoperculum and the anterior part of the operculum. Pachyrhizodontids generally have broad posterior infraorbitals but they are never as well developed as in *Goulmimichthys arambourgi*. The posterior half of the infraorbitals 3, 4 and 5 bears fine radiating ridges.

The dermosphenotic (Dsp) is large and covers the dilatator fossa as in *Rhacolepis* and *Pachyrhizodus megalops*. Its dorsal margin is convex and fits a corresponding concavity of the frontal bone.

#### Hyopalatine series and gill arches (Figs. 6 and 7)

The hyomandibular (Hy) has a broad articular head. A well-developed crest runs along the shaft, which is slightly posteriorly tilted and masks in lateral view the opening for the hyomandibular trunk of the facial nerve. Several little canals

cross the body of the bone near the opercular process. In lateral view, another crest lies on the anterior part of the articular head and runs down to the anterior margin of the bone. The dorsal part of the metapterygoid (Mpt) rests on this crest.

The quadrate (Q) and the symplectic (Sy) of *G. arambourgi* are similar to those of *Rhacolepis*.

The entopterygoid (Enpt) bears ventrally a dental plate (d.p), which was covered by numerous minute pointed teeth (only a few teeth are still present on BHN 2P15). *Notelops* and *Rhacolepis* also have minute teeth on the entopterygoid but they are granular and not pointed (Forey 1977).

The ectopterygoid (Ecpt) is edentulous like the one of *Notelops* and unlike the one of *Rhacolepis*, which bears a row of pointed teeth (Forey 1977).

The palatine is a more complex bone than that of *Rhacolepis* and *Notelops*. It is composed of a dermopalatine (Dpal) and an autopalatine (Apal) fused together. The autopalatine part of the bone is deep and bears dorsoposteriorly a well-developed facet, probably for the articulation with the dermethmoid (not observed), and an anteroventral broad maxillary process (mx.pr). The dermopalatine part of the palatine forms a horizontal plate situated posterolaterally to the vomer. It bears numerous alveolae that should have contained teeth probably similar in size and shape to those of the entopterygoid (Fig. 7).

The anterior ceratohyal (Ch.ant) is fenestrated as in *Rhacolepis*. It bears ventrally about 10 thin branchiostegal rays (Br.r). The posterior ceratohyal (Ch.post) is shorter and triangular in shape. There is a small fenestra close to the posterodorsal edge of the bone. It bears ventrally about 8 broad branchiostegal rays.

The urohyal of *Goulmimichthys arambourgi* is similar to the one of *Rhacolepis* (Forey 1977).

#### Opercular series (Fig. 5)

The preoperculum (Pop) looks like the one of *Rhacolepis* with a wide and truncated dorsal limb and a rounded ventral limb with an excavated anteroventral margin.

The operculum (Op), suboperculum (Sop) and interoperculum (Iop) look like the ones of *Rhacolepis*.

#### Pectoral girdle and fin (Figs. 5 and 8)

The supratemporal (Stt) is semicircular and does not meet its fellow. It bears the intersection of three sensory canals and a notch on its lateral margin for the exit of the otic sensory canal. The supratemporal is smaller than the one of *Rhacolepis* and the supratemporal commissure must have run in the skin above the supraoccipital.

The posttemporal is formed by a very thin epioccipital limb and an intercalary limb with a slightly enlarged extremity. The supracleithrum is large and bean-shaped.

The cleithrum (Cl) has a slightly curved dorsal limb with parallel anterior and posterior margins. Its dorsal extremity

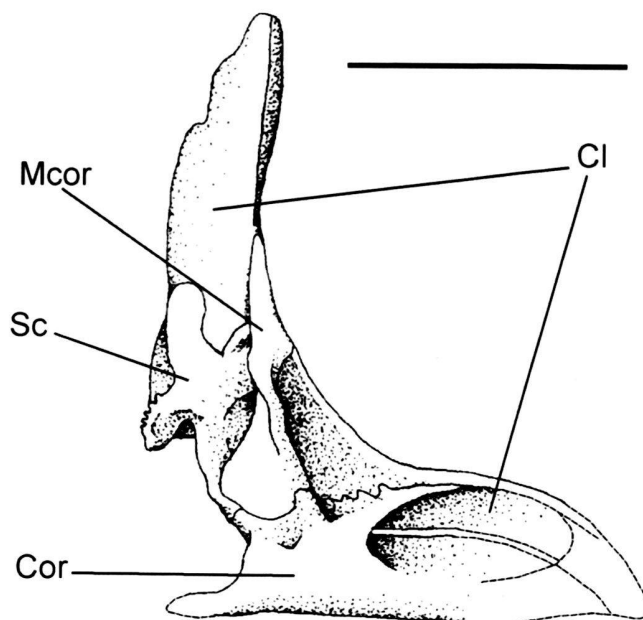

Fig. 8. *Goulmimichthys arambourgi*, reconstruction of the left pectoral girdle in medial view. Scale bar: 10 mm.

forms a blunt spine and its posterior margin is concave at the fin insertion.

The scapula (Sc) completely contains the large scapular foramen. The scapula extends posteriorly as a process with indentation on its margin, which is applied against the medial face of the cleithrum, and dorsally as a well developed process lying against the dorsal limb of the cleithrum.

The mesocoracoid (Mcor) extends dorsally along the anterior margin of the vertical limb of the cleithrum and is medially articulated with the coracoid. The coracoid (Cor) has a well-developed horizontal limb, and bears a groove running on its lateral margin. A large foramen opens between the coracoid and the cleithrum.

There are at least three proximal radials and the shortest one bears three articulating heads distally.

The pectoral girdle of *Goulmimichthys arambourgi* is almost similar to the one of *Rhacolepis*, except the presence of a well-developed dorsal process on the scapula.

Unlike *Rhacolepis*, the pectoral fin of *G. arambourgi* is held horizontally. It is composed of 15 rays and the outermost one is unbranched and very thick as in *Pachyrhizodus megalops*. The dorsal lepidotrich of the proximal part of the outermost ray is anteriorly segmented.

#### Pelvic girdle and fin (Fig. 9)

The pelvic fin origin is situated posteriorly to the origin of the dorsal fin (Fig. 12). The pelvic bone is equal in length to 4 abdominal vertebrae. It differs from the one of *Rhacolepis* by its anterior process (ant.pro), which is very thin and elongated.

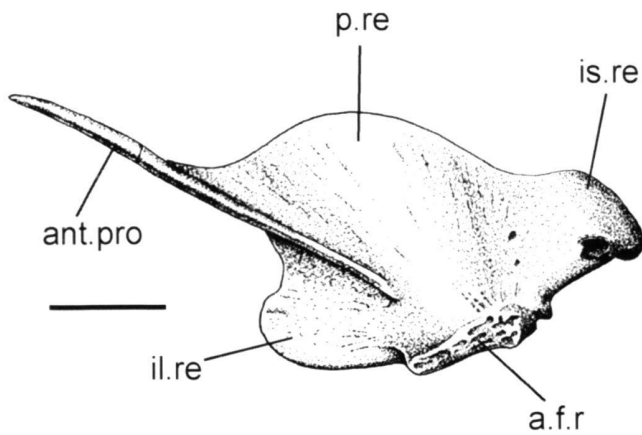

Fig. 9. *Goulmimichthys arambourgi* (BHN 2P2), left pelvic bone in dorsal view. Scale bar: 5 mm.

The ischial region (is.re) forms a well-developed process that meets its fellow medially and was presumably capped by cartilage (Forey 1977). There is a broad lateral process in the iliac region (il.re), which is rounded and not spinuous as in *Rhacolepis*. Posterolaterally is a large facet for the articulation with the radials (a.f.r). The pelvic fin is composed of 13 rays.

#### Dorsal fin (Fig. 12)

The dorsal fin originates above the twenty-first vertebra. The number of pterygiophores is unknown. The first ones are the largest, being equal in length to 2,5 vertebrae. The pterygiophores form lanceolate blades with median keel on their posterior face. The specimen BHN 2P15 shows a pair of very small bones visible above a pterygiophore, presumably the sixth. According to the description of *Elops lacerta* by Taverne (1974), these bones should be baseosts and the pterygiophore below them should be regarded as the ventral part of the axonost. In *E. lacerta*, the dorsal part of axonosts are absent in association with the eight first pterygiophores, and are small bones either paired or unpaired according to their position on the fin and to individual variations.

The number of dorsal fin rays is unknown.

Nothing is known about the anal fin

#### Axial skeleton (Figs. 10 and 12)

The exact number of vertebrae is unknown. There are about 23 abdominal and about 26 caudal vertebrae, without the ural centra. The centra are as deep as long. The neural arches are autogenous in the abdominal region and fused with their centrum in the caudal region. On the anterior most vertebrae, the neural arches are laterally spread out and their neural spines are paired. The anterior most centra bear ventrally two anterior pits in which probably rested autogenous parapophyses.

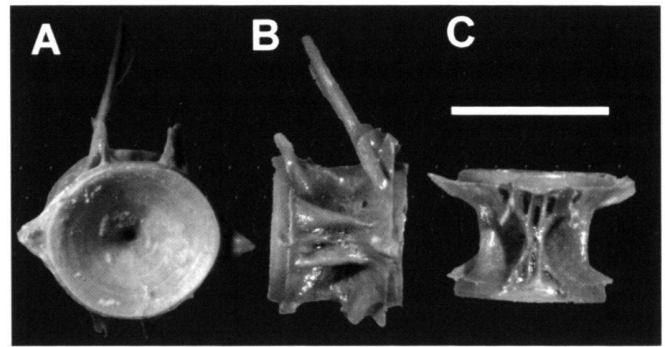

Fig. 10. *Goulmimichthys arambourgi* (BHN 2P10), caudal vertebra in anterior (A), lateral (B) and ventral (C) views. Scale bar: 5 mm.

Then posteriorly, the parapophyses become more elongated and fused to their centra. The lateral surface of the abdominal centra is ornamented by deep longitudinal irregular ridges. The ribs are thin with a flat and broad articular head. Epineurial bones are present but the count is unknown. The more anterior ones are laterally fused to the neural arches. One specimen (BHN 2 P 15) shows intermuscular bones ventrally associated to the last abdominal vertebrae: they are regarded here as epipleural bones. On the caudal region, the neural and haemal arches are fused to the anterior part of the centra (Fig. 10). The caudal centra bear ventral anterior and posterior zygapophyses. They are laterally ornamented by three excavations dorsoventrally arranged, and separated by two longitudinal ridges.

#### Caudal skeleton (Fig. 11)

Up to now a single caudal skeleton of *Goulmimichthys arambourgi* is known (BHN 2 P 3). It belongs to an incomplete specimen, which may be assigned to *G. arambourgi*: most of the skull is not preserved except its posterior-most part, showing the typical spiny posterior process of the pterotic, and the pelvic bone bears the typical process in its ischial region.

The parhypural (Ph) bears laterally a hypurapophysis (hyph). The parhypural is fused to the first preural centrum, which is fused itself with the second preural centrum (Pu1+Pu2) as indicates the presence on this complex of a true haemal arch and spine anterior to the parhypural (hs.Pu2), and the presence dorsally of two bases of neural arches (na.Pu1+na.Pu2). Hypurals (H) 1 and 2 are completely fused together. The dorsal hypural plate is broad and is regarded here as the result of the fusion of the hypurals 3 and 4. Both ventral and dorsal hypural plates are fused together proximally on half of their length, and fused to the first ural centrum. At least two more free hypurals are present. The hypurostegy (overlap of the bases of the lepidotrichs on the hypurals) is significant (Fig. 11C). Two uroneurals (Un) at least are present. Although partially broken, the first uroneural appears to be forked anteriorly and overlies the first three preural centra

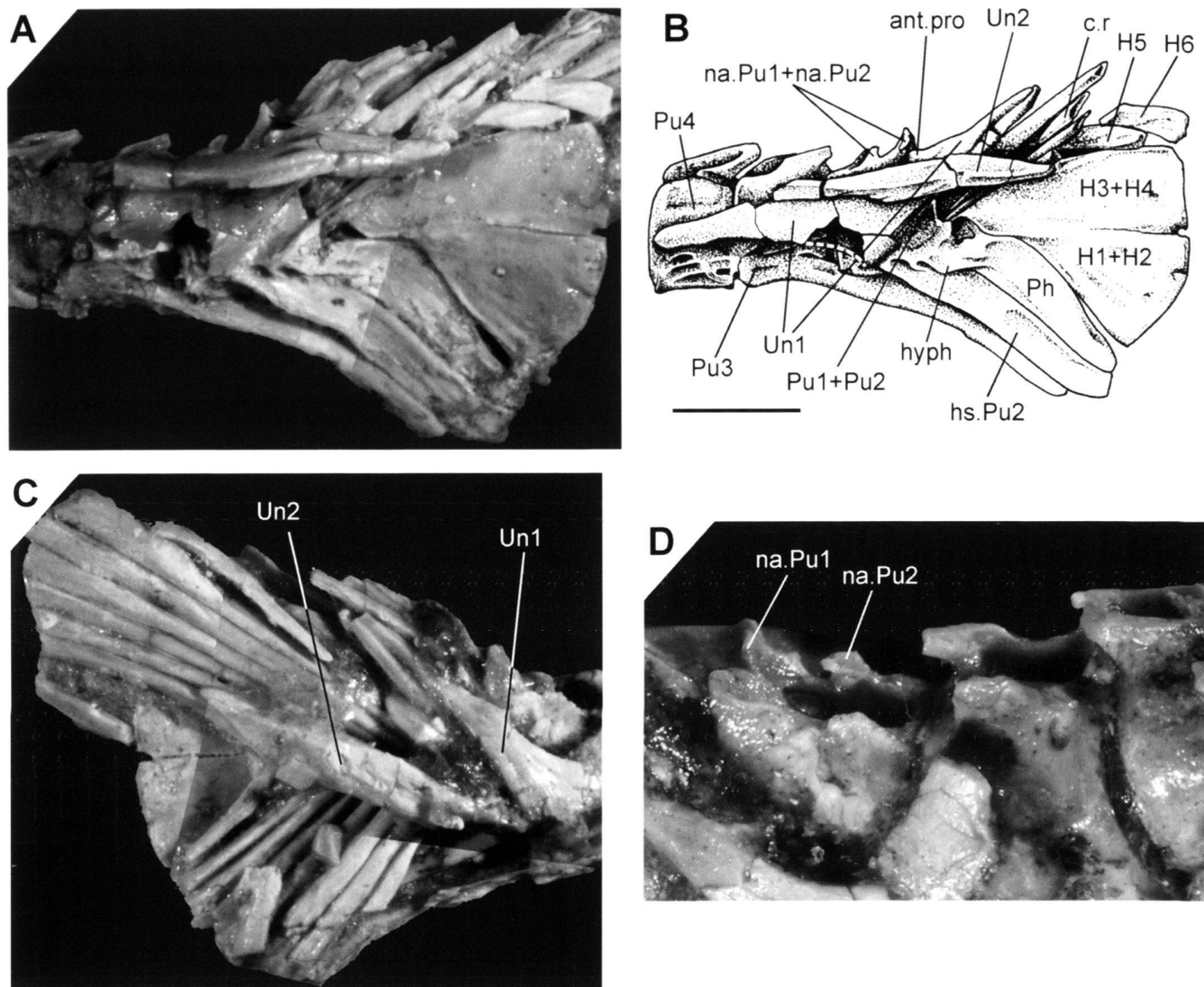

Fig. 11. *Goulmimichthys arambourgi* (BHN 2P3), photograph (A) and drawing (B) of the caudal skeleton in left lateral view without caudal rays. The white dotted line on B shows the reconstruction of the outline of the uroneural 1. Photograph in right lateral view with the caudal rays (C), and detail of the last preural vertebrae in dorsolateral view (D). Scale bar: 5 mm.

(Pu1+Pu2, Pu3, Pu4). It bears on its dorsal margin a small anterior projection (ant.pro). The second uroneural bears a ridge on its lateral face. The epurals are unknown, as well as the general outline of the caudal fin.

#### Squamation

The cycloid scales are thin, more deep than long. The anterior third bears irregular radiating ridges and some small pores. The two posterior thirds bears circuli spaced by about 40 micrometers. The transverse count just behind the pectoral girdle is about 9 above and 15 below the lateral line row. The lateral line scale count is unknown.

#### 4. Phylogenetic relationships

Cavin (1995) regarded *G. arambourgi* as a pachyrhizodontid according to the diagnosis of this family proposed by Forey (1977): the skull is lateroparietal; the skull roof is broad and convex in the otic region; the frontal margin is excavated above the autosphenotic spine; there is no subtemporal fossa; the intercalar is small and does not reach the prootic; the trigeminal foramen opens directly into the orbit; the parasphenoid is deep beneath otic region; the ectopterygoid bears teeth (sic); the lower jaw has an angulo-articular and retroarticular; the dentary bears a single row of teeth and the gular plate is absent.

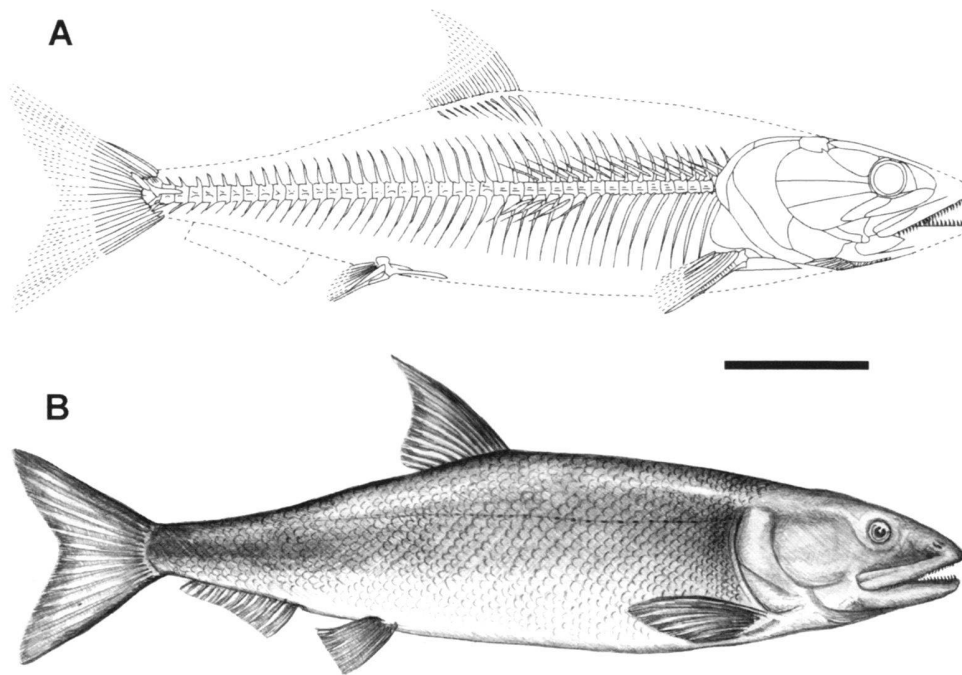

Fig. 12. *Goulmimichthys arambourgi*, skeletal reconstructions without (A) and with (B) squamation and skin. Scale bar: 50 mm.

#### 4.1 Historical review

The Pachyrhizodontidae is an extinct family of primitive teleost created by Cope in 1872 to group *Pachyrhizodus* and other related forms (which are probably synonyms of *Pachyrhizodus* according to Forey 1977). Since, other species of *Pachyrhizodus*, *Elopopsis*, *Thrissopater* and *Rhacolepis buccalis* have been included in the family Pachyrhizodontidae. The family has been assigned to different teleostean lineage, but was generally regarded as Elopiformes, mainly because of the presence of primitive teleostean characters. A revision of pachyrhizodontids was performed by Forey in 1977: he synonymized *Thrissopater* with *Pachyrhizodus*, and created the suborder Pachyrhizodontoidei and the family Notelopidae for the single species *Notelops brama*. He regarded the Pachyrhizodontoidei (Pachyrhizodontidae and Notelopidae) as Teleostei *incertae sedis*. Then, Taverne (1980) included *Platinx macropterus*, *Greenwoodella tockensis* (Taverne 1991) and *Tingitanichthys heterodon* (Taverne 1996) in the pachyrhizodontids. Maisey (1991b) rejected the monophyly of pachyrhizodontoids. Maisey & Blum (1991a) stressed synapomorphies shared by *Paraelops*, pachyrhizodontids and notelopids, and regarded these three taxons as Elopomorpha *incertae sedis*.

Taverne (1989) grouped the Pachyrhizodontoidei and the Crossognathoidei in the order Crossognathiformes. He regarded the crossognathiforms as the sister-group of Clupeomorpha-Euteleostei. Previously the crossognathids were placed at the level of *Tharsis dubius* in the cladogram of Patterson & Rosen (1977), i.e. as the sister-group of Osteoglossomorpha-Elopocephala.

Patterson (1993a) regarded the crossognathiforms as Clupeocephala *incertae sedis* and included in this order the suborder Tselfatoidei. Patterson (1967) had previously assigned the plethodids (=“Plethodontidae”) into tselfatoids, together with the bananogmiids, the protobramids and the tselfatiids. Taverne (1975) excluded the protobramids from the tselfatoids, and included them into the esocoids, order “salmoniforms”. He retained in the Tselfatoids three families, the plethodids, the tselfatiids and the bananogmiids, and regarded this suborder as elopiform fishes related to albuloids. Then Taverne (1983) regarded *Tselfatia formosa* as the sister-group of the clade Clupeomorpha-Euteleostei. Recently, Taverne (1999, 2000a, b, c, d, 2001) gathered *Tselfatia* with *Bananogmius* and other genera into the order Tselfatiiforms (still regarded as the sister-group of the set Clupeomorpha-Euteleostei).

*Araripichthys castilhoi*, included in the monotypic family Araripichthyidae, is a bizarre teleost fish first regarded as an acanthopterygian beryciform by Silva Santos (1985). Maisey & Blum (1991b) rejected this assignment and regarded *A. castilhoi* as an Elopocephala *incertae sedis*. They cited resemblance between *Araripichthys* and lampridiforms, but not pertinent enough to prove phylogenetic relationships. The assignment of *Araripichthys* to Elopocephala *incertae sedis* was retained by Cavin (1997) without any discussion. Patterson (1993a, b) placed *Araripichthys castilhoi* close to pachyrhizodontids, or to *Albula*, without precise argument. Taverne (1996) also regarded *A. castilhoi* as a pachyrhizodontid, mainly on caudal evidence.

In 1998, Arratia & Chorn described two Ferrifronsidae: *Acanthichthys major* and *Ferrifrons rugosus*. They regarded this family as indeterminate acanthopterygians. Ferrifronsids

share similarities with araripichthyids, which lead me to include *A. major* in the analysis.

According to this review, the hypotheses to be tested here are: [1] Are the Pachyrhizodontidae monophyletic? [2] Are the Pachyrhizodontoidei monophyletic? [3] Are the Crossognathiformes monophyletic? [4] Are the Pachyrhizodontidae related to Elopomorpha? [5] What are the relationships between Pachyrhizodontoidei, Tselfatiiformes, *Araripichthys*, *Protobrama*, *Acanthichthys*, Esocoidei and Acanthopterygii?

#### 4.2 Species included in the analysis

The species included in the analysis are those mentioned in the historical review, i.e., all the pachyrhizodontid fishes and representatives belonging to groups once regarded as related to this family: *Notelops* for the notelopids, *Araripichthys* for the araripichthyids, *Acanthichthys* for the ferrifronsids, *Protobrama* for the protobramids, *Bachea*, *Tselfatia* and *Bananogmius* for the tselfatiiforms, *Albula* and *Paraelops* for the albuliforms, *Elops* for the elopids, *Crossognathus* and *Apsopelix* for the crossognathids, *Esox* for the esocoids, *Hoplopteryx* for the acanthopterygians and *Leptolepis coryphaenoides* as outgroup. The data gathered in the cladistic analysis come from literature and from personal observations mentioned in the following list:

*Acanthichthys major* Arratia & Chorn, 1998, from the Lower Turonian of the USA, according to the description of Arratia & Chorn (1998).

*Albula vulpes* (Linnaeus, 1758), extant, according to the description of Forey (1973) and Monod (1968) for the caudal skeleton.

*Apsopelix anglicus* (Dixon, 1850), from the Cenomanian-Campanian of Europe and North America, according to the descriptions of Patterson & Rosen (1977), and Teller-Marshall & Bardack (1978).

*Araripichthys castilhoi* Silva Santos, 1985, from the Albian of the Santana Formation, Brazil, according to the description of Maisey & Blum (1991b).

*Araripichthys corythophorus* Cavin, 1997, from Lower Turonian of Morocco, according to personal observations (one specimen housed in the Natural History Museum in Boulogne-sur-mer, France [BHN 2P35]).

*Bachea huilensis* Paramo-Fonseca, 1997, from the Turonian of Colombia, according to the description of Paramo-Fonseca (1997).

*Bananogmius ellisensis* Fielitz & Shimada, 1999 and *Bananogmius aratus* (Cope, 1877), from the Upper Cretaceous of the USA, according to the descriptions of Fielitz & Shimada (1999), Nelson (1973b) and Taverne (2001).

*Crossognathus sabaudianus* Pictet, 1858, from the Albian and Aptian of Europe, according to the descriptions of Patterson & Rosen (1977) and Taverne (1989).

*Elops* Linnaeus, 1766, extant, according to the descriptions of Nybelin (1956, 1960, 1968, 1971), Forey (1973) and Taverne (1974).

*Elopopsis crassus* Dixon, 1850, from the Turonian of England, according to the description of Forey (1977).

*Elopopsis microdon* Heckel, 1856, from the Cenomanian of Morocco and Croatia, according to the descriptions of Forey (1977) and Taverne (1976b).

*Esox lucius* (Linnaeus, 1758), extant, according to the data matrix of Arratia (1997) and Johnson & Patterson (1996), and to personal observations (one specimen housed in the Musée cantonal de zoologie of Lausanne, Switzerland [MZL 12530]).

*Goulmimichthys arambourgi* Cavin, 1995, from Lower Turonian of Morocco, described herein.

*Greenwoodella tockensis* Taverne & Ross, 1973 according to the description of Taverne (1973, 1981, 1991) from the Lower Aptian of Germany.

*Hoplopteryx lewesiensis* (Mantell, 1822), from the Late Cretaceous of England and France, according to the descriptions of Patterson (1964, 1968) and to personal observations (Cavin, in press a).

*Leptolepis coryphaenoides* (Bronn 1830), from the Lower Jurassic of Europe, according to the descriptions of Nybelin (1974), Patterson & Rosen (1977) and Arratia (1997).

*Notelops brama* Agassiz, 1841, from the Albian of the Santana Formation, Brazil, according to the descriptions of Forey (1977), Taverne (1976a) and Maisey (1991a).

*Pachyrhizodus megalops* (Woodward, 1901), from the Cenomanian of England, according to the description of Forey (1977).

*Pachyrhizodus salmoneus* (Günter, 1872), from the Albian of England and France, according to the descriptions of Forey (1977), and Wenz & Fricot (1985).

*Pachyrhizodus basalis* Dixon, 1850, from the Cenomanian and Turonian of England and France, according to the descriptions of Forey (1977), and Cavin (in press a).

*Paraelops cearensis* Silva Santos, 1971, from the Albian of the Santana Formation, Brazil, according to the description of Maisey & Blum (1991a).

*Platinx macropterus* (De Blaiville, 1818), from the Eocene of Monte Bolca, Italy, according to the description of Taverne (1980) and to personal observations of specimens housed in the Muséum national d'Histoire naturelle, Paris.

*Protobrama avus* Woodward, 1942, from the Cenomanian of Lebanon, according to the descriptions of Patterson (1967) and Taverne (1975).

*Rhacolepis buccalis* Woodward, 1901, from the Albian of the Santana Formation, Brazil, according to the descriptions of Forey (1977) and Maisey (1991b).

*Tingitanichthys heterodon* (Arambourg, 1954), from the Cenomanian of Jebel Tselfat, Morocco, according to the description of Taverne (1996).

*Tselfatia formosa* Arambourg, 1943, from the Cenomanian of Jebel Tselfat, Morocco and of Cinto Eugeano, Italy; from the Coniacian-Santonian of Texas, USA; from the Cenomanian-Turonian of Labistica, Croatia, and of Germany, and from the Turonian of Vallecillo, Mexico, according to the descriptions of Arambourg (1954), Patterson (1967), Taverne (1975,

1983, 2000a), Bardack and Teller-Marshall (1980), Maisch & Lehmann (2000) and to personal observations of specimens from the Jebel Tselfat locality (DTS) housed in the Muséum national d'Histoire naturelle, Paris, and to personal observation of undescribed specimens from Vallecillo, Mexico.

#### 4.3 Characters analysis

##### Braincase characters

(1) Parietals in contact with each other along their midline [0]; separated by the supraoccipital [1]. This character was stressed by numerous authors. The state of this character in *Tselfatia formosa* was much debated: Arambourg (1954) and Taverne (1983) described a lateroparietal (derived condition) skull roof, when Patterson (1967), Sorbini (1976) and Taverne (2000a) described a medioparietal (primitive condition) skull roof in this species. Although this part of the skull roof of the material kept in the MNHN is poorly preserved, my own observations lead to confirm the primitive state of this species. The specimens of *T. formosa* from Vallecillo also display a medioparietal skull roof.

(2) Supraoccipital crest absent or small [0]; large, projecting dorsally and/or posteriorly above the occipital region [1]. This character is likely to have appeared independently among different teleosts lineage such as, for instance, in the gonorhynchiforms (Grande & Poyato-Ariza 1999), in the mormyroids (Cavin & Forey 2001) and in the euacanthomorphs, in which the supraoccipital forms a *spina occipitalis* (Johnson & Patterson 1993). The derived state is present in some of the compared species, but, when known, never with a *spina occipitalis* (doubtful in *A. major* [Arratia & Chorn 1998]), but in *Hoplopteryx* (Patterson 1964).

(3) Pterotic posteriorly straight [0]; produced to a spine [1]. This character was regarded as diagnostic for *Rhacolepis* by Forey (1977); it is also present in other genera.

(4) Parietal portion of the supraorbital sensory canal present [0]; absent [1]. This feature characterises the pachyrhizodontoids (Forey 1977; Taverne 1989), whereas it seems absent in *Greenwoodella* (Taverne 1981, 1991). Taverne (1983) did not illustrate a portion of the supraorbital sensory canal in the parietal of *Tselfatia*, but I observed such a portion on one specimen from Jebel Tselfat (DTS 56G). The plesiomorphic condition is present in *Hoplopteryx* (Johnson & Patterson 1993).

(5) Ethmoid commissure enclosed in the mesethmoid [0]; absent [1] (Forey 1977).

(6) Supraorbital sensory canal running within a bone-enclosed tube on the anterior part of the frontal [0]; within a shallow groove [1]. The apomorphic condition is observed in albuloids (*sensu* Forey *et al.* 1996), *Paraelops* and *Hoplopteryx*.

(7) No direct connection between the otic sensory canal and the supraorbital sensory canal [0]; direct connection between the otic sensory canal and the supraorbital sensory canal directly from the pterotic into the frontal [1]. The connection between both sensory canals through a bone-enclosed canal or

a fenestra (there is not always a connection of the soft tissue lumen of both canals) is a synapomorphy of osteoglossomorphs minus *Hiodon* (Cavin & Forey 2001). According to the literature, this character is present in *Crossognathus* (Taverne 1989), *Tingitanichthys* (Taverne 1996), and *Tselfatia* (Taverne 1983) (Fig. 13). In the single available specimen of *Araripichthys corythophorus* (BHN 2P35), the supraorbital sensory canal is visible as a ridge on the frontal. It forms an angle in the centre of the ossification, runs above the autosphenotic and opens posteriorly by two pores situated close to the limit with the pterotic. The path of the otic sensory canal may not be followed in the pterotic but, according to the pattern of the supraorbital canal, we can assume that a bone-enclosed connection between both is present (Fig. 13).

(8) Suture between intercalar and prootic present [0]; absent [1]. This character was regarded as diagnostic for the pachyrhizodontids (Forey 1977). A suture between these two bones may be secondarily present, for instance in notopterids (Cavin & Forey 2001).

(9) Basipterygoid process present [0]; absent [1]. In *T. formosa*, the state of this character was regarded either as primitive (Taverne 1983) or as derived (Taverne 2000). One specimen of *T. formosa* from Vallecillo (n° 121) shows that the parasphenoid forms a relatively wide dental plate (probably fused teeth), but shows no trace of basipterygoid process.

(10) Teeth on parasphenoid present [0]; absent [1]; fused into a dental plate [2].

(11) Vomer with teeth [0]; without teeth [1]; with two recurved teeth [2] (Forey 1977).

(12) Sub-epiotic fossa absent [0]; present [1]. Character present in albuloids (Forey *et al.* 1996), in *Araripichthys* (Maisey & Blum 1991b), but also in ichthyodectiforms and clupeomorphs (Maisey 1999). Patterson (1964, fig. 48) described in *Hoplopteryx lewesiensis* a fossa lying on the posterior side of the neurocranium and straddling the suture between exoccipital and epiotic, which is regarded here as homologous to the sub-epiotic fossa.

(13) Large fenestra between autosphenotic and pterotic in the wall of the dilatator fossa absent [0]; present [1]. Autapomorphy of *Notelops* (Forey 1977).

(14) Fenestra between pterosphenoid and autosphenotic uniting orbit with dilatator fossa absent [0]; present [1]. Autapomorphy of *Araripichthys* (Maisey & Blum 1991b; Cavin 1997). Taverne (1980) described a lack of ossification between the pterotic and the autosphenotic in *Platinx macropterus*, but this structure is not sufficiently known to be homologized with the one of *Araripichthys*.

(15) Frontal margin excavated above the autosphenotic spine and fitting the dorsal margin of the dermosphenotic absent [0]; present [1]. This feature characterises the pachyrhizodontids (Forey 1977), but is however absent in *Tingitanichthys heterodon*, which is regarded as a pachyrhizodontid by Taverne (1996). The frontal margin is excavated in *Albula* but the concavity is more anteriorly situated and does not fit the dermosphenotic.

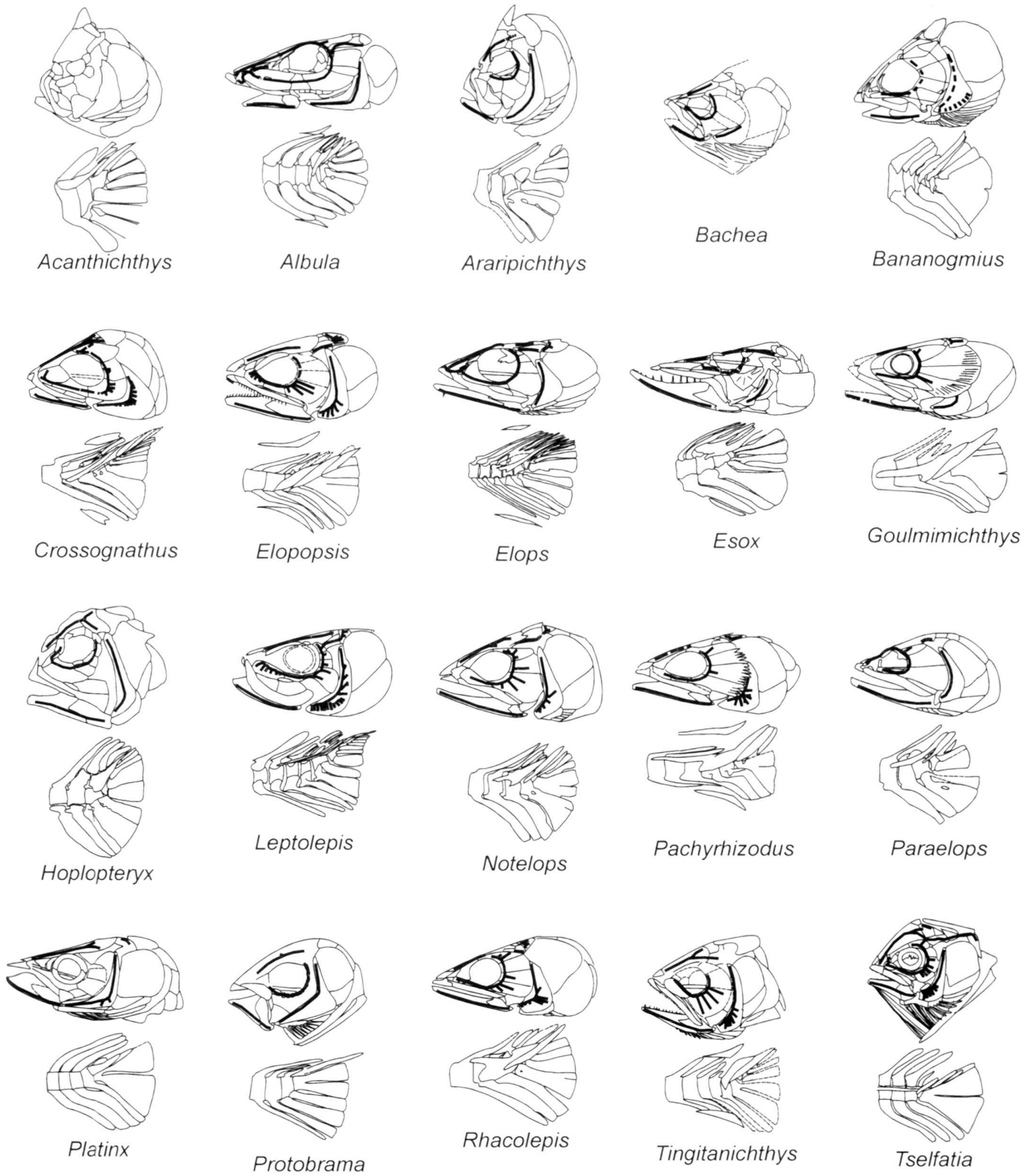

Fig. 13. Schematic drawings of the head (top) and caudal skeleton (bottom) of the genera included in the phylogenetic analysis. Bold lines show the path of sensory canal. Genera are arranged in alphabetic order. The fishes are redrawn from various references cited in the paragraph "species includes in the analysis".



(16) Intercalar normal in size [0]; small [1]. This feature characterises the crossognathids (Taverne 1989).

(17) Interorbital septum absent [0]; present [1].

(18) Trigeminal foramen opens into *pars jugularis* [0]; directly to orbit [1]. This feature characterises the pachyrhizodontids (Forey 1977), but is also present in *Apsopelix anglicus* (Teller-Marshall & Bardack 1978) and *Hoplopteryx lewisiensis* (Patterson 1964). Among pachyrhizodontids, *Rhacolepis buccalis* has a single opening for the trigeminal foramen situated above the anterior opening of the jugular canal. In *Pachyrhizodus megalops* there is one more separate opening for the exit of the *profundus ciliaris* (V bis) located above the trigeminal foramen. In *Goulimichthys arambourgi* there are also two openings additional to the anterior opening of the jugular canal but the more dorsal one was most probably the exit of the superficial ophthalmic of the trigeminal and facial nerves. The difference of interpretation in this foramen between *P. megalops* and *G. arambourgi* rests on the large size of this opening in the latter species. A separate opening for the exit of the superficial ophthalmic of the trigeminal and facial nerves is present in several Cretaceous Aulopiformes (Goody 1969; Cavin 1999) and acanthopterygians (Patterson 1964).

#### Other possible braincase characters

A rectangular-shaped, heavily ossified lateral ethmoid is a derived character among teleosts. This feature was used by Arratia & Chorn (1998) to characterise the family Ferrifronsidae, in which is included *Acanthichthys major*. The character is also present in *Araripichthys corythophorus* (Cavin 1997). It may be associated with the short and deep skull of these fishes. Its phylogenetic meaning remains unclear.

The roof of the otic region of the braincase becoming broader and more convex, the roof of the dilatator fossa becoming very narrow, or absent altogether, above the autosphenotic, the autosphenotic spine increasing in relative size and the subtemporal fossa disappearing are probably interrelated characters and concerned with the lateral movements of the hyomandibular and opercular apparatus, which Forey (1977) used to characterise pachyrhizodontids. In *Tselfatia*, the otic region of the skull roof is very convex and the articular facet for the hyomandibular is laterally and very posteriorly situated (Taverne 1983; personal observation). Although the absence of the subtemporal fossa may not be proved on the available material of *Tselfatia*, the structure of this part of the braincase may be similar to the one of pachyrhizodontids. This derived condition may be also present in *Protobrama avus* and *Bachea huilensis*. In *Araripichthys*, and probably in *Acanthichthys major*, the otic region of the skull roof is also very convex, but the position of the articular facet for the hyomandibular is more medially situated, and the organisation is likely not homologous to the one of pachyrhizodontids (articular facet not laterally situated). I regarded now the definition and the distribution of this character as unclear to be included in the analysis.

Maisey (1991a) stressed a character tentatively regarded as a synapomorphy uniting notelopids and pachyrhizodontids with elopomorphs: the presence of a pair of small foramina near the top of the supraoccipital crest, leading from the posterior face of the braincase into the posttemporal fossa. Maisey observed this character in *Rhacolepis*, *Notelops*, *Paraelops* and *Brannerion*, as well as in Recent *Elops*, *Megalops* and *Albula*, although he recognised that the homology of this character in the latter species with the others ones is uncertain. This character is also present in *Pachyrhizodus megalops* (Forey 1977) and *Goulimichthys arambourgi*. However Greenwood (1970) did not mention such foramina in *Megalops cyprinoides*, Forey (1973) in *M. cyprinoides*, *M. atlanticus* and *Elops hawaiiensis* and Taverne (1974) in *Elops lacerta*. Consequently this character is apparently too unstable to be retained in the phylogenetic study.

Other braincase characters with important phylogenetic significance are: first centrum with anterior surface bearing distinct facets that articulate with the exoccipital condyles and presence of a rostral cartilage (Johnson & Patterson 1993). But the former character is rarely visible and the latter one is never preserved in fossil material, and cannot be included in the analysis.

#### Circumorbital bones

*Goulimichthys arambourgi* has five free infraorbitals (plus the dermosphenotic) and not four as previously written (Cavin 1995), i.e. it shows the primitive condition in teleosts [however, polymorphism may occur in the number of infraorbital bones, as Grande & Bemis (1998) exemplify with the Recent *Amia calva*]. There is no antorbital bone in *G. arambourgi* but the circumorbital ring is however complete because of the well developed anteroventral region of the supraorbital bone. *Notelops brama* and *Paraelops cearensis* have three infraorbitals, and *Rhacolepis buccalis* has four. The dorsal infraorbital of *Notelops* and *Paraelops* is clearly the result of the fusion of infraorbitals 4 and 5. But in *Notelops*, *Paraelops* and *Rhacolepis*, the origin of ventral infraorbitals may be either the result of a fusion between infraorbitals 2 and 3, forming the large posteroventral infraorbital (Forey 1977), or the result of a fusion between infraorbitals 1 and 2, forming the anteroventral infraorbital (Taverne 1989). Consequently, two derived characters may be stated:

(19) Infraorbitals 1, 2 and 3 free [0]; infraorbitals 1+2 or 2+3 fused together [1].

(20) Infraorbitals 4 and 5 free [0]; infraorbitals 4 and 5 fused together [1]. The derived state is also observed in some osteoglossomorphs (Li & Wilson 1996; Arratia 1999).

Other characters related to the circumorbital ring are:

(21) Few (3 to 5) relatively large infraorbitals [0]; infraorbitals consisting of a chain of small ossicles [1]. Autapomorphy of *Protobrama avus* (Patterson 1967).

(22) Antorbital and first infraorbital free [0]; fused together [1]. The derived state, observed in *Crossognathus*, is demon-

strated by the presence in the compound bone of a small dorsally oriented portion of the infraorbital sensory canal (Taverne 1989), the antorbital branch. The derived state is also present in all heterotidins, but *Laeliichthys* (Li & Wilson 1996).

(23) Antorbital bone present [0]; absent [1]. This feature characterises pachyrhizodontoids (Forey 1977; Taverne 1989), but it is also present in others of the compared species.

(24) Supraorbital bone present [0]; absent [1].

(25) Suborbital bone present [0]; absent [1].

#### Other possible circumorbital characters

The presence of prenasal and rostral ossicles in which runs the ethmoid commissure is generally regarded as an autapomorphy of elopomorphs. But this character has been shown to be artefact of preparation (Arratia 1997).

A "large dermosphenotic meeting a large supraorbital" is a derived character used by Forey (1977) to characterise the pachyrhizodontoids and by Taverne (1989) to characterise the crossognathiforms. But this character shows all gradient of development among the compared species and cannot be used here without a clear definition of its states.

#### Suspensorium

(26) Toothed free dermopalatine [0]; fused with autopalatine [1]; absent [2] (modified from Arratia 1997; 1999).

(27) Teeth on the ento- and/or ectopterygoids present [0]; teeth absent on both ento- and ectopterygoids [1].

#### Jaws

(28) Teeth on the jaws present [0]; absent [1].

(29) Jaws bearing numerous villiform teeth absent [0]; present [1] (modified from Arratia 1997; 1999). I observed traces of numerous villiform teeth on the lower jaw of several specimens of *Tselfatia formosa* from Jebel Tselfat kept in the MNHN of Paris (T 25, DTS 52, DTS 53D, DTS 55G, DTS 56G), as Taverne (2000a) mentioned.

(30) Premaxilla with a well developed ascending process absent [0]; present [1].

(31) Atrophied premaxilla (its length is less than 10% of the total length of the upper jaw) absent [0]; present [1]. This feature characterises the crossognathoids according to Taverne (1989).

(32) Prominent inner premaxillary teeth absent [0]; present [1].

(33) Tooth base of the maxilla covered laterally by a narrow ledge of thin bone absent [0]; present [1]. According to Taverne (1980), the maxilla of *Platinx macropterus* is not visible on the available material. However, the specimen 10964 (MNHN, Paris) shows the impression of the maxilla: its oral margin is slightly convex, without lateral ledge of bone and apparently edentulous

(34) Supramaxilla present [0]; absent [1].

(35) Quadrate-mandibular articulation below the posterior

half of the orbit [0]; below anterior half of the orbit [1]; posterior to orbit [2]. According to Arratia (1997, 1999), a third apomorphic state may be defined (articulation anterior to the orbit), but this is not observed in the species compared here. The plesiomorphic condition is observed in *Bananogmius aratus* (Taverne, 2001) and the condition [2] in *B. ellisensis* (Fielitz & Shimada, 1999).

(36) Retroarticular bone included in the joint facet for quadrate [0]; excluded from the joint [1] (Patterson & Rosen 1977; Arratia 1997, 1999).

(37) Fusion between articular, angular and retroarticular [0]; fusion between angular and retroarticular [1], fusion between articular and angular [2]; three ossification free [3].

The pattern of fusion between the bones of the lower jaw was used to characterise different teleosteans lineage (Nelson 1973a; Patterson & Rosen 1977). Arratia (1997) questioned (p. 122) or refuted (p. 152) the fusion of angular and retroarticular as a synapomorphy of Elopomorpha because this condition represents the juvenile condition in *Elops*, the articular being involved in the fusion during growth. But because the fusion between articular and the anguloretroarticular is always partial, this derived state is discernible from the primitive one (fusion between the three bones).

In *Tselfatia formosa*, the retroarticular seems to be partially fused to the angular (Taverne 2000). I regard the condition in *T. formosa* as the state [1] of the character. An anguloretroarticular is also present in other north American Tselfatiiformes (Nelson 1973b).

(38) Posterior opening of the mandibular sensory canal placed medial [0]; lateral to the angular portion of the jaw [1] (Arratia 1997).

(39) A system of ossified ligaments between the mandibular and cleithral symphyses absent [0]; present [1].

#### Fins

(40) First dorsal pterygiophore as bipartite or tripartite structure [0]; single structure [1] (Arratia 1997).

(41) Both dorsal and anal fins well developed, ending posteriorly close to the caudal peduncle, absent [0]; present [1] (Fig. 14).

(42) Pelvic fin present [0]; absent [1] (Fig. 14).

(43) Length of pectoral fin less than  $\frac{1}{4}$  of the standard length [0]; pectoral fin hypertrophied (equal or more than  $\frac{1}{4}$  of SL) [1] (Fig. 14).

(44) Pectoral fin inserted ventrally [0]; inserted high on the trunk and concomitant elongation of the cleithrum and coracoid [1] (Fig. 14).

(45) Dorsal and anal unpaired fin-spines absent [0]; present [1]. Synapomorphy of acanthomorphs (Johnson & Patterson 1993). The apomorphic state occurs in *Acanthichthys major* and *Hoplopteryx lewesiensis*. Others species of our sample (*Araripichthys*, *Tselfatia*, *Protobrama*, *Tingitanichthys*) have non-segmented dorsal fin-spine but, as far as we know, they are always paired elements.

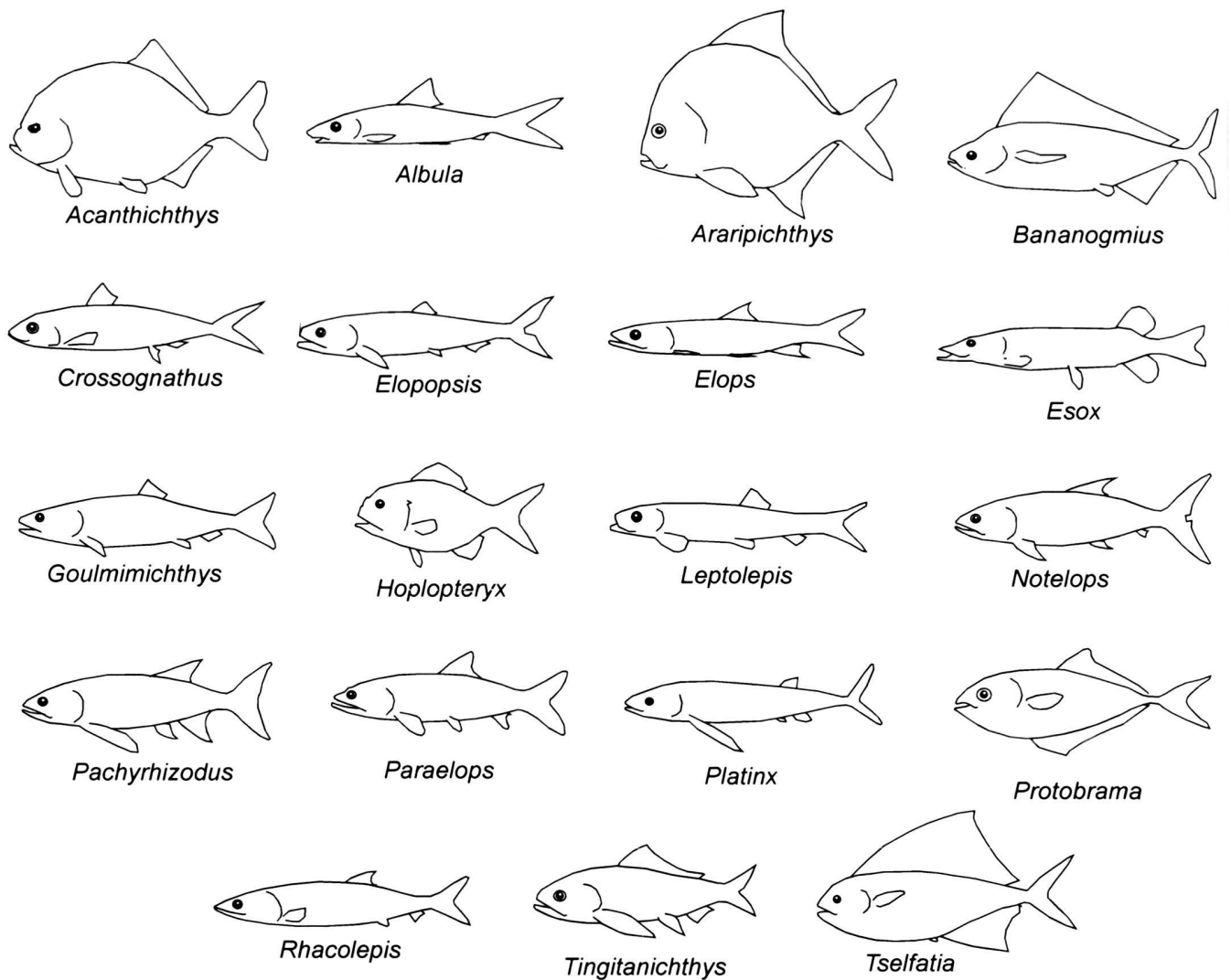

Fig. 14. Schematic drawings of the general outlines of the genera included in the phylogenetic analysis. Genera are arranged in alphabetic order. The fishes are redrawn from various references cited in the paragraph "species includes in the analysis".

#### Vertebrae

(46) Abdominal centra with unfused neural arches [0]; with fused neural arches, except for the first ones [1]; with fused neural arches [2] (slightly modified from Arratia 1997).

(47) Neural spines thin [0]; anteroposterior widening of part or all of the abdominal neural spines, forming a median vertebral septum [1].

(48) Epineural bones associated with abdominal vertebrae only [0]; last epineural bones associated with caudal vertebrae [1]; absent [2]. Patterson (1967) illustrated *Tselfatia formosa* without epineurals associated with the anterior most caudal vertebrae in contrast to Taverne (1983). My own observations of specimens of *T. formosa* from Jebel Tselfat and from Vallecillo confirm the Patterson's view.

(49) Epipleural bones absent [0]; present [1].

#### Caudal skeleton

(50) Hypurapophysis absent [0]; present [1] (Arratia 1997, 1999). An hypurapophysis is not mentioned in *Paraelops cearensis* by Maisey & Blum (1991a), but their figure of the caudal skeleton (p. 247) shows a process as the one regarded as an hypurapophysis in the *Elops*-like sp. 2 by Arratia (1997); this character is coded 1 for *P. cearensis* herein. A parhypural is said to be missing in *Tselfatia formosa* (Taverne 1975; 1983 *contra* his figure 5 p. 174) and *Bananogmius aratus* (Taverne 2001), and the small last free centrum with a short neural spine is regarded as PU1. Generally, the identification of preural vertebra 1 is based on the presence of the last haemal arch, the parhypural, enclosing the caudal blood vessels (Arratia & Lambers 1996). Consequently, the parhypural may not be absent by definition. However, Nelson (1973b) described in two

specimens of the tselfatiiform *Bananogmius* a “haemal” process suggesting that the small centrum primitively was associated with a haemal arch, presumably the parhypural, and Taverne (1999, 2000a) pointed out that the most primitive species of tselfatiiforms still have a short haemal arch (without spine) or a well-developed parhypural (Taverne 2000c) associated with the last free centrum. These observations lead to accept the disappearance of the “original” parhypural in *Tselfatia*; the haemal arch of PU2 takes the place of the “original” parhypural.

(51) Fusion of preural centrum 1 (PU1) and parhypural absent [0]; present [1]. This character is regarded as unknown in *Tselfatia formosa* and *Bananogmius aratus*, because the “original” parhypural is not present

(52) Neural spine of preural centrum 2 (PU2) shorter than neural spine of PU3 [0]; as long as neural spine of PU3 [1] (Arratia 1997, 1999).

(53) Neural spine and/or arch of ural centra 1 and 2 or the “first” ural centrum reduced [0]; absent [1]; forming a compound neural arch in cartilage over PU1 [2]; forming a stegural (first uroneural fused with pre-ural neural arch material) [3]. The derived state 2 is regarded as a synapomorphy of Elopomorpha by Patterson & Rosen (1977). The condition of this character is unclear in *Notelops brama*: Taverne (1976a) described a “stegural” formed by the fusion of the neural arches of PU1, U1 and the first uroneural, Forey (1977) described an arcual element which probably represents the first preural arch fused with the first ural neural arch and Maisey (1991a) illustrated a structure almost similar to those described by Taverne (with an anterior expansion) but that he regarded as a simple uroneural. This character is regarded here as indeterminate for *N. brama*.

(54) Three or more epurals [0]; two epurals [1]; one epural [2]; epural absent [3]. Both conditions [0] and [1] are apparently present in *Notelops brama* [two epurals according to Taverne (1976) and Forey (1977) and three according to Maisey (1991a)].

Seven or more uroneurals is primitive for teleosts. Following the analysis of Arratia (1997), one can observe a decrease in the number of the anterior uroneurals (anterior to or reaching the first ural centrum) and of the posterior uroneurals. I define here the following derived conditions for the uroneurals:

(55) Three anterior uroneurals [0]; two anterior uroneurals [1]; one anterior uroneural [2]; no anterior uroneural [3] (decreasing by fusion or loss). *Hoplopteryx lewesiensis* is regarded as having one anterior uroneural (included into the stegural) (Patterson 1968).

(56) Three posterior uroneurals [0]; two posterior uroneurals [1]; one posterior uroneural [2]; no posterior uroneural [3] (decreasing by fusion or loss).

Taverne (1975, 1983) observed no uroneural in *Tselfatia formosa*. However, an isolated caudal skeleton (DTS 355, MNHN Paris), typical of *T. formosa* by the well developed ventral and dorsal hypural plates and by the important hy-

purostegy, shows two wide, short and very inclined uroneurals, and possibly a thin third uroneural applied against the posterior margin of the second one (Fig. 13). The anterior uroneural is the single one to reach the first preural centrum, and is thus an anterior uroneural, the other two being posterior ones. Chanet (1997) and Taverne (2000c) described an isolated caudal skeleton from the Albian of Southern France, which they attributed to a primitive plethodid; it shows a single uroneural anterodorsally enlarged.

(57) Uroneural 1 (UN1) extends forwards to PU2 [0]; to PU1 [1].

(58) Forked anterior extremity of the anterior most uroneural, regarded as an incomplete fusion of two uroneurals, absent [0]; present [1]. Both states are apparently present in *Notelops brama* (Taverne 1976a; Forey 1977; Maisey 1991a). The first uroneural of *Araripichthys castilhoi* is slightly forked (Silva Santos 1985).

The decrease by loss of fusion of the number of hypurals is apomorphic for teleosts. This trend forms a simple linear transformation series, which can be transcribed in the matrix by additive binary coding (Wiley *et al.* 1991):

(59) Hypural 9 present [0]; absent [1].

(60) Hypural 8 present [0]; absent [1].

(61) Hypural 7 present [0]; absent [1].

(62) Hypural 6 present [0]; absent [1].

(63) Hypurals 1 and 2 autogenous and applied against ural centra 1 and 2, or “first” ural centrum, [0]; hypurals 1 and 2 fused with the ural centrum [1].

(64) Hypurals 1 and 2 unfused together [0]; proximal extremities of hypurals 1 and 2 fused together [1]; hypurals 1 and 2 fused together on more than half of their length [2]. A combination of the derived state of characters (64) and (65) was used by Taverne (1989) as a synapomorphy of Crossognathiformes.

(65) Dorsal hypurals unfused together [0]; fusion between two or more dorsal hypurals [1].

The last three characters are variable in *Elopopsis microdon* (Taverne 1976b, 1993) and character (65) is variable in *Notelops brama* (Forey 1977; Maisey 1991a).

(66) Caudal scutes present [0]; absent [1] (Arratia 1997).

(67) The bases of the dorsal most principal rays of the caudal fin crossing obliquely over the entire upper hypural series [0]; aligned with hypurals so that no fin-ray base overlies more than one hypural [1] (Arratia 1997). Both conditions are apparently present in *Pachyrhizodus* (Forey 1977; Taverne 1987).

#### Squamation

(68) Fins not covered with scales [0]; base of the dorsal fin, at least, covered with fine scales [1].

#### 4.4 Phylogenetic analysis

The data matrix of the taxa set is presented in Table 1. The osteology of *Greenwoodella* turned out to be too poorly known;



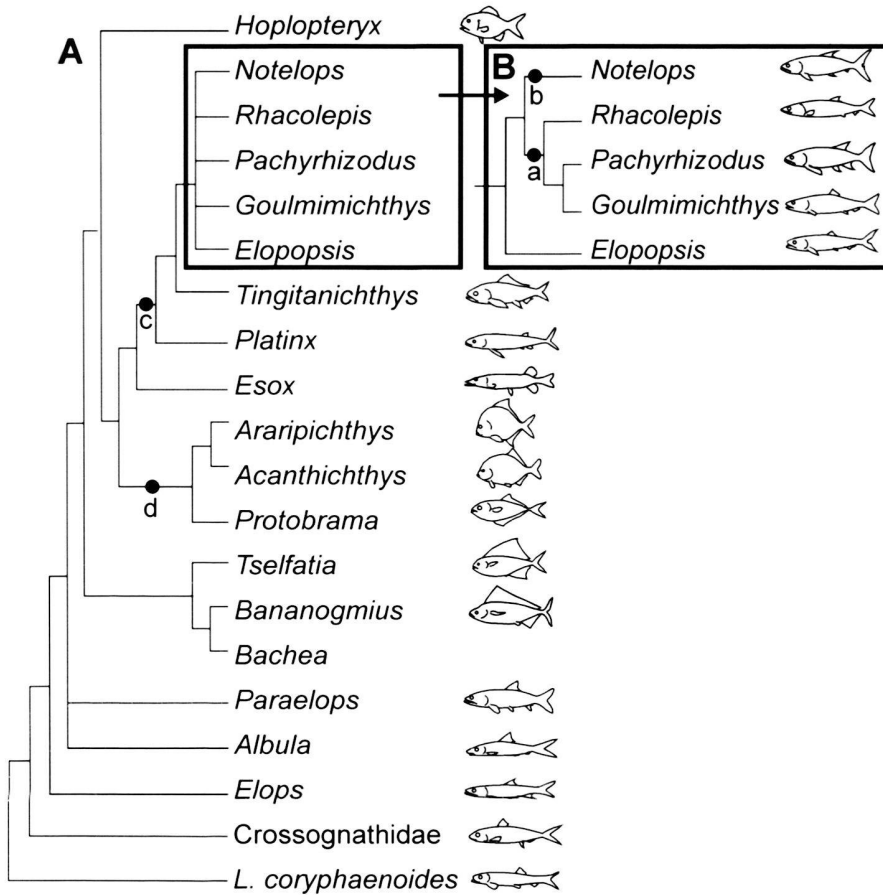

Fig. 15. A. Strict consensus tree of the six equally most parsimonious trees; 196 steps; CI 0.43; RI 0.53. B. 50% major-rule consensus tree. The tree is similar to A, except for the section included in the frame. a: Pachyrhizodontidae, b: Notelopidae, c: Pachyrhizodontoidei, d: Protobramoidei. nov.

vious assignment of this family as sister-group of pachyrhizodontoids by Taverne (1989) without the use of cladism. According to the cranial characters only, the positions of *Goulmimichthys*, *Notelops* and *Hoplopteryx* are different from their positions in the tree calculated with the whole data set, indicating that the cranial characters alone are not fully representative of phylogenetic relationships for these taxa: *Goulmimichthys* and *Notelops* are located in more basal positions than on the tree built with the whole data set, and *Hoplopteryx* is located as the sister-group of (*Acanthichthys* + *Araripichthys*). The tree built with post-cranial data (Fig. 17C) shows a very low resolution of interrelationships of the taxa, and shows one inconsistency with the figure 15: the grouping of *Esox* + *Hoplopteryx* (likely because of the presence in both of a stegural).

## Results

According to the most parsimonious distribution of the derived characters (Fig. 15), the monophyly of the Pachyrhizodontoidei is confirmed in part. However, the position of *Notelops* is unclear: it is located in a polytomy with *Elopopsis*, *Goulmimichthys*, *Pachyrhizodus* and *Rhacolepis* on the strict

consensus tree (Fig. 15A). *Notelops* is likely situated as the sister-group of these taxa, exclusive of *Elopopsis*, as show four of the six equally most parsimonious trees (Fig. 15B). The examination of characters shows that the latter grouping plus *Elopopsis* rests on one uniquely derived character: prominent inner premaxillary teeth [32]; on two derived homoplastic characters: well developed supraoccipital crest [2], and, possibly, frontal margin excavated above the autosphenotic [15]; and on a reversal unique among the set of compared taxa: first uroneural lengthened forwards to PU2 [57]. These four characters (Fig. 16) strongly support the monophyly of this clade. Among it, *Rhacolepis*, *Pachyrhizodus* and *Goulmimichthys* are gathered in a clade forming the pachyrhizodontids defined by a set of homoplasies: presence of a hypurapophysis [50], forked anterior extremity of the anterior most uroneural [58], and presence of six or less uroneurals [62] (Fig. 16). *Tingitanichthys* is resolved as the sister-group of (Pachyrhizodontidae + *Notelops* + *Elopopsis*), on the basis of three homoplasies: primitively edentulous vomer [11], infraorbitals 1+2 or 2+3 fused together [19], and PU1 fused with Ph [51]; on two reversals: epineural bones associated with the abdominal vertebrae only [48], and two anterior uroneurals [55]; as well as a possible uniquely derived character: absence of dermopalatine

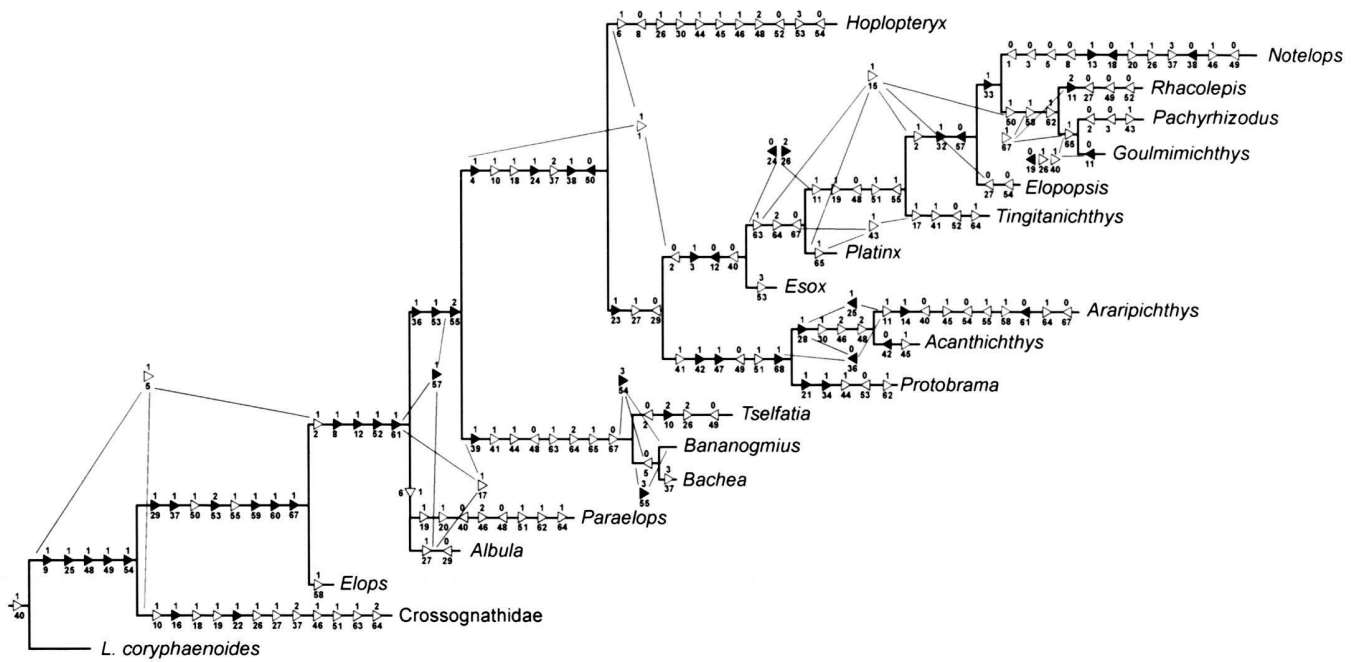

Fig. 16. 50% major-rule consensus tree showing the transformation events. The types of change are represented by arrowheads. Right-facing arrowheads: apomorphies; left-facing arrowheads: reversals; solid black: autapomorphies and empty: homoplasies. Transformation events with equivocal positions are mentioned outside the main lines; those with too many equivocal positions are not mentioned on the tree (35, 56, 66).

[26:2]; and a possible unique reversal: presence of a supra-orbital bone [24] (Fig. 16). *Platinx* is resolved as the sister-group of ((*Pachyrhizodontidae* + *Notelops* + *Elopopsis*) + *Tingitanichthys*) on the basis of two homoplasies: hypurals 1 and 2 are fused with the ural centrum [63], and hypurals 1 and 2 are fused together on more than half of their length [64: 2]; and on one reversal: base of the dorsal most principal rays of the caudal fin crossing obliquely over the entire upper hypural series [67] (Fig. 16).

Consequently, I regard the Pachyrhizodontidae (*Rhacolepis*, *Pachyrhizodus* and *Goulmimichthys*) and the Notelopidae (*Notelops*) as two monophyletic families (Fig. 15B nodes a and b), both grouped into the monophyletic suborder Pachyrhizodontoidae. *Elopopsis*, *Tingitanichthys* and *Platinx* are regarded here with caution as Pachyrhizodontoidae *incertae sedis* (Fig. 15A node c).

The Crossognathiformes do not appear to be monophyletic. Crossognathids are characterised in the analysis by several homoplasies: they are actually much more basal than the pachyrhizodontoids, and are situated as the sister-group of all the compared set of genera, but *Leptolepis coryphaenoides*. Compared with the phylogenetic relationships of teleosts proposed by Arratia (1999, fig. 19), crossognathids share with varasichthyids and more derived teleosts a foramen for the vagus nerve placed in posterolateral face of exoccipital alone and no fringing fulcra in median fins (but crossognathids have no diastema between hypurals 2 and 3 on the contrary of varasichthyids). Moreover, the crossognathids and some vara-

sichthyids also have 6 uroneurals, *circa* 10 hypurals, and their first uroneurals reach PU3. Finally, the crossognathids share synapomorphies of varasichthyids (Arratia 1997, 1999): articular fused with angular [37:2] (independently acquired in Clupeocephala), ventroposterior region of preopercle broadly expanded, premaxilla atrophied (Arratia 1981; Arratia & Schultze 1985), parasphenoid extending posterior to basioccipital in *Apsopelix anglicus* (Teller-Marshall & Bardack 1978) and *Varasichthys ariasi* (Arratia 1981).

These clues may possibly indicate close phylogenetic relationships between crossognathids and varasichthyids; this hypothesis should be tested in further studies.

*Praelops* and *Albula* (Albuliforms) are here resolved in a trichotomy with the more derived taxa (Fig. 15). *Praelops*, *Albula* and *Elops* are not lumped together into a monophyletic group. I do not regard this result as a definitive clue of the paraphyly of Elopomorpha because the sample of elopomorpha taxa under study is small and not representative of the whole group. Moreover, I did not consider in the analysis a character generally considered as a synapomorphy of Elopomorpha, the presence of a leptocephalous larva, because it is normally not visible on fossil specimens (but see exceptions described from the Late Jurassic of Bavaria, Arratia 1997).

Pachyrhizodontoids are not related to elopomorpha, neither to Albuliforms, or to *Elops*.

*Araripichthys* is resolved as the sister-group of *Acanthichthys*, and *Protobrama* as the sister-group of both (Fig. 15). *Araripichthys* and *Acanthichthys* share one derived character

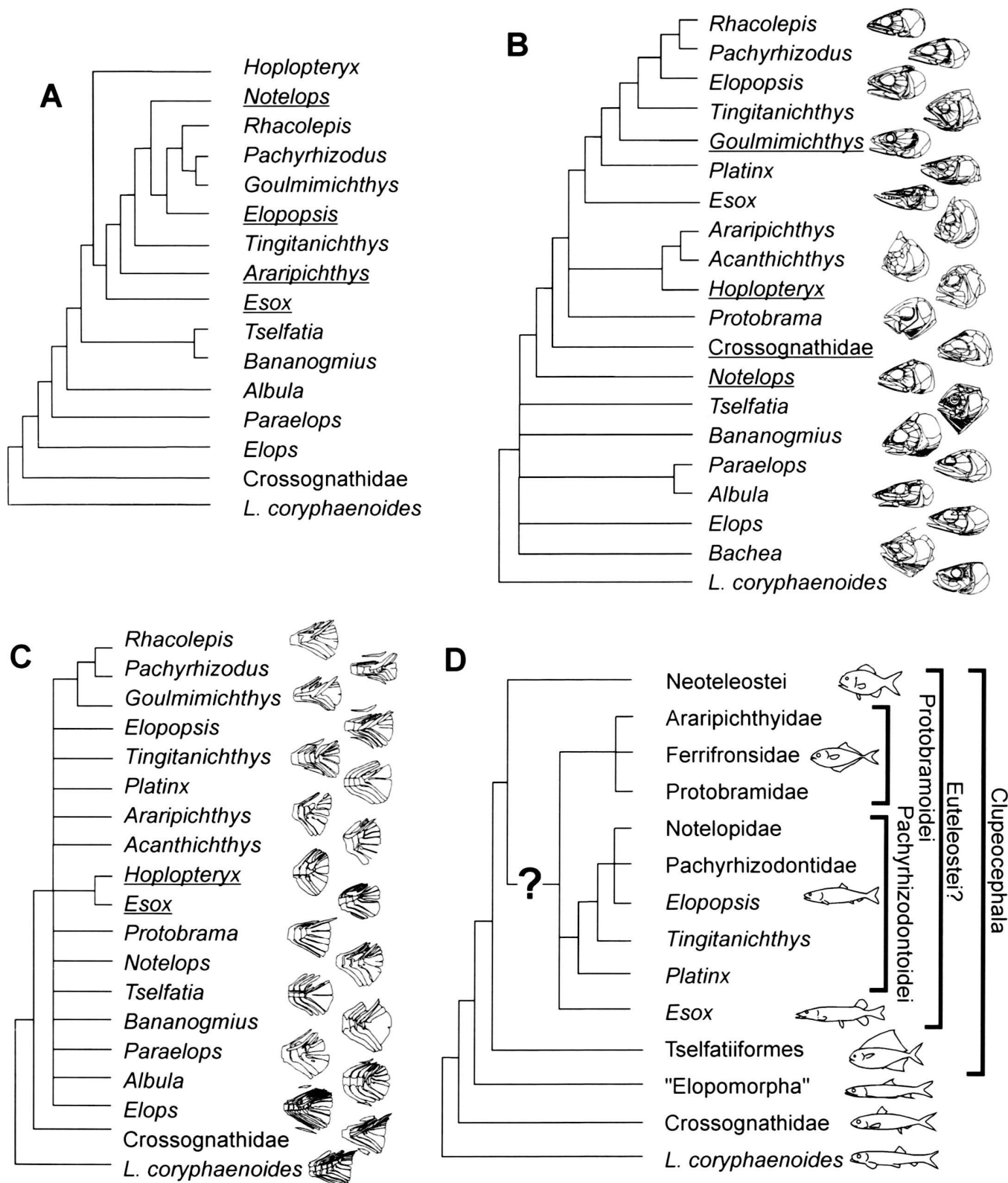

Fig. 17. A: Effect of exclusion of taxa with more than 30% of missing data (*Acanthichthys*, *Bachea*, *Platinx*, *Protobrama*); one strict consensus tree 180 steps; CI 0.47; RI 0.48. B: strict consensus tree with cranial characters only (1–39). C: strict consensus with post-cranial characters only (40–68). A–C: underlined taxa are those situated in locations conflicting their locations on figure 15. D: Hypothesis of phylogenetic relationships of the clades under study.



unique among the set of compared species: no teeth on the jaws [28]; two derived characters also present in *Hoplopteryx*: premaxilla with a well developed ascending process [30], and no epineural [48:2]; and one derived character also present in *Paraelops*: abdominal centra with fused neural arches [46:2] (Fig. 16). *Protobrama* shares with *Araripichthys* and *Acanthichthys* three uniquely derived characters: absence of pelvic fins (reversed in *Acanthichthys*) [42], presence of a median vertebral septum formed by anteroposterior widening of part or all of the abdominal neural spines [47], and base of the dorsal fin, at least, covered with fine scales [68]. The three genera also share homoplasies ([41], [51]) and one reversal ([49]) (Fig. 16). As demonstrated by the experimental analysis of the data set, the grouping of these three taxa into a monophyletic group is not only due to characters linked with a particular fins insertions and a particular mode of locomotion. These three fishes, representing three distinct families (Araripichthyidae, Ferrifronsidae, Protobramidae) are gathered into a new suborder named Protobramoidei nov. (Fig. 15A node d). The phylogenetic relationships of Protobramoidei are not obvious, as shows the tree calculated with the taxa with more than 30% of missing data deleted: the respective positions of *Araripichthys* and *Esox* are inverted (compare Figs. 15A and 17A). In any case, *Acanthichthys* does not appear to be related to *Hoplopteryx*, and may not be regarded here as an acanthopterygian (the grouping of *Hoplopteryx* and (*Acanthichthys* + *Araripichthys*) is however observed when cranial characters only are used, Fig. 17B).

According to the cladistic analyses, *Protobrama* is not related to *Esox* as proposed by Taverne (1975).

The monophyly of the Tselfatiiformes (Taverne 1999, 2000a) is confirmed herein (*Tselfatia*, *Bananogmius*, *Bachea*). The grouping of tselfatoids with the pachyrhizodontoids and the crossognathoids into the Crossognathiformes (Patterson 1993a) is rejected according to the present study.

#### 4.5 Discussion

The topic of this paper is not to clear up the phylogenetic relationships between major teleostean clades, but to discuss the interrelationships of fossil groups among the phylogenetic framework of teleosts proposed first by Patterson & Rosen (1977), then by Arratia (1997, 1999) and Johnson & Patterson (1996) among others.

The synapomorphies of Clupeocephala defined by Arratia (1999) used in the present analysis are: retroarticular bone excluded from the joint for quadrate [36], fusion between articular and angular [37: 2], neural spine and/or arch of ural centra 1 and 2 or the "first" ural centrum absent [53], six or less hypurals [61].

Two of the four characters ([36] and [53]) sustain the node uniting tselfatiiforms and more derived taxa (Fig. 16). Consequently, the clupeocephalan level is placed at this node (Fig. 17D). The derived state 2 of character [37] is a synapomorphy of Clupeocephala minus Tselfatiiformes. At this internode also

lies the character [38], posterior opening of the mandibular canal placed lateral to the angular portion of the jaw, which was proposed by Arratia (1997, 1999) as an osteoglossocephalan character (Osteoglossocephala groups Osteoglossomorpha + Clupeocephala according to Arratia 1997, 1999). The third character of Clupeocephala defined by Arratia, six or less hypurals [61], is a synapomorphy of "albuliforms" and the more derived taxa (Fig. 16). According to this survey, the pachyrhizodontoids and the protobramoids appear to be clupeocephalans *sensu stricto*. Tselfatiiforms are regarded as basal clupeocephalans, showing only some of the synapomorphies previously defined for the group. These phylogenetic relationships are close to those obtained by Taverne (2000a), except that the position of Tselfatiiforms and "Crossognathiformes" are reversed (probably because Taverne gathered crossognathids and pachyrhizodontoids).

The relationships of Pachyrhizodontoidei (and Protobramoidei) among Clupeocephala are more difficult to resolve. None of these taxa show synapomorphies of Clupeomorpha or Ostariophysi (lumped together into a monophyletic group named Otocephala [Johnson & Patterson 1996] or Ostarioclupeomorpha [Arratia 1997]). The most striking result regarding Pachyrhizodontoidei and Protobramoidei is that they form a monophyletic group with *Esox*, whatever the respective positions of *Esox* and *Araripichthys* (Figs. 15A and 17A). The sister-group of this clade is *Hoplopteryx*. The clade (Pachyrhizodontoidei + Protobramoidei + *Esox*) is sustained by one uniquely derived character: antorbital bone absent [23]; a homoplasy: no teeth on the ento- and ectopterygoids [27]; and one reversal: villiform teeth on the jaws absent [29]. Johnson & Patterson (1996) recognised among the lower euteleostean fishes the Protacanthopterygii, comprising the Salmoniformes and the Argentiniformes, and the Neognathi, comprising the Esociformes and the neoteleosts. The presence of a roofed posttemporal fossa in Pachyrhizodontoidei and Protobramoidei exclude them from the Salmoniformes. The ectopterygoid is primitively toothed in neoteleosts, and the combination of characters [23] and [27] is found only in esociforms among lower euteleosts (Johnson & Patterson 1996). Consequently, I propose to regard the Pachyrhizodontoidei and the Protobramoidei as probable basal euteleosteans, but not neoteleosteans, which are possibly related to Esociformes (Fig. 17D). Further cladistic analyses using larger samples of lower euteleosteans are necessary to test this hypothesis.

Emended diagnoses based on combinations of derived characters and reversals are proposed for the following taxa:

#### Protobramoidei nov.

Clupeocephalans in which dorsal and anal fins are well developed, ending posteriorly close to the caudal peduncle; pelvic fins primitively absent; neural spines bear anteroposterior widening of part or all of the abdominal neural spines, forming a median vertebral septum; base of the dorsal fin, at least, covered with fine scale; PU1 and Ph fused together; no epipleural

(reversal); and parietals in contact with each other along their midline (either primitive condition or reversal according to the cladistic analysis).

#### Pachyrhizodontoidei

Clupeocephalans in which there are primitively prominent inner premaxillary teeth; well developed supraoccipital crest; frontal margin excavated above the autosphenotic; first uroneural lengthened forwards to PU2 (reversal); and, possibly, tooth base of the maxilla covered laterally by a narrow ledge of thin bone.

More doubtful characters, which are dependant of the number of genera included in the suborder (*Tingitanichthys*, *Platinx*) are: vomer primitively edentulous; absence of dermopalatine; infraorbitals 1+2 or 2+3 fused together; epineural bones associated with the abdominal vertebrae only (reversal); PU1 fused with Ph; two anterior uroneurals; hypurals 1 and 2 fused with the ural centrum; hypurals 1 and 2 fused together on more than half of their length; and bases of the dorsal most principal rays of the caudal fin cross obliquely over the entire upper hypural series (reversal).

#### Notelopidae

Pachyrhizodontoidei in which a large fenestra between autosphenotic and pterotic in the wall of the dilatator fossa is present; infraorbitals 4 + 5 fused together; dermopalatine and autopalatine fused together; angular, articular and retroarticular are free ossification; and abdominal centra with fused neural arches, except the first ones. Notelopidae also show several reversals: skull roof medioparietal; posteriorly straight pterotic; ethmoid commissure enclosed in the mesethmoid; a suture between the intercalar and the prootic; trigeminal foramen opens into the *pars jugularis*; posterior opening of the mandibular sensory canal placed medial to the angular portion of the jaw; and no epipleural.

#### Pachyrhizodontidae

Pachyrhizodontoidei in which the hypurapophysis is present; anterior extremity of the anterior most uroneural forked anteriorly; six hypurals; and, possibly, bases of the dorsal most principal rays of the caudal fin are aligned with hypurals so that no fin-ray base overlies more than one hypural.

### 5. Conclusion

I recapitulate the questions asked in paragraph 4.1 with their answers: [1] are the Pachyrhizodontidae monophyletic? The monophyly of pachyrhizodontids is proved but weakly supported. The Pachyrhizodontidae include now the genera *Rhacolepis*, *Pachyrhizodus* and *Goulmimichthys*. [2] Are the Pachyrhizodontoidei monophyletic? The monophyly of pachyrhizodontoids is proved. Pachyrhizodontoidei include the Pachyrhizodontidae and the Notelopidae, as well as

*Elopopsis*, *Tingitanichthys* and *Platinx*, which are regarded now as pachyrhizodontoids *incertae sedis*. [3] Are the "Crossognathiformes" monophyletic? The "Crossognathiformes" are not monophyletic. Crossognathids are possibly related to varasichthyids, but this hypothesis remains to be tested. [4] Are the Pachyrhizodontidae related to Elopomorpha? The pachyrhizodontoids (and pachyrhizodontids) are not related to Elopomorpha; they are Clupeocephala *sensu stricto*, and are likely primitive Euteleostei. [5] What are the relationships between Pachyrhizodontoidei, Tselfatiiformes, *Araripichthys*, *Protobrama*, *Acanthichthys*, Esocoidei and Acanthopterygii? Tselfatiiformes are basal Clupeocephala, not related to Pachyrhizodontoidei. *Acanthichthys* does not appear to be an Acanthopterygii; it is gathered into a monophyletic group with *Protobrama* and *Araripichthys*. This clade, named Protobramoidei nov., is resolved as the sister-group of (pachyrhizodontoids + *Esox*) on the strict consensus tree, or more cautiously, as a trichotomy (Protobramoidei + Pachyrhizodontoidei + *Esox*) after an experimental analysis of the data set. This clade is, however, weakly supported and further cladistic analyses using larger sets of lower euteleosteans species are necessary to test its reality. The sister-group of (Protobramoidei + Pachyrhizodontoidei + *Esox*) is *Hoplapteryx*, regarded as representative of the Neoteleostei. The Pachyrhizodontoidei and the Protobramoidei are probable basal euteleosteans, but not neoteleosteans, which are possibly related to Esociformes.

The Pachyrhizodontoidei and the Protobramoidei constitute two groups of teleosts restricted to the Cretaceous, with the exception of the Pachyrhizodontoidei *incertae sedis* *Platinx*, which is known from deposits of the Eocene of Italy. The protobramoids, restricted to Albian – Turonian stages, occur as far as we know in Tethyan domain and in North America Interior sea only. Their morphology indicates paraxial swimmers and manoeuvrability specialists, living likely in quite localised environment close to the shore (all specimens of protobramids have been discovered in deposits from epicontinental carbonate platforms), and with a weak ability for long distance trips. These features distinguished them from the superficially similar tselfatiiforms, which were thunniform swimmers able to practice great speed or long distances at moderate speed swim. On the other hand, the pachyrhizodontids display a large geographical distribution and stratigraphical range. They are mentioned in Europe (UK, France, Italy, Slovenia, Netherlands), North America (Canada, USA, Mexico), South America (Brazil, Venezuela, Colombia), Australia, New Zealand and Africa (Morocco). The oldest records of this family are from the Aptian of Europe and Venezuela and the youngest ones are from the Campanian-Maastrichtian of Mangahouanga Stream, New-Zealand, (Wiffen 1983), and from the Maastrichtian of Netherlands (Leriche 1929). The general morphology and fin insertion of the fusiform pachyrhizodontids are typical of fast-swimmer predators with potentialities for widespread geographic dispersal. This family is regarded, with other fast-swimmer marine pelagic bony fish families, as a

probable victims of the Cretaceous-Tertiary event, mainly because of their position in the marine trophic food chain (Cavin in press b).

## Acknowledgements

The descriptive part of this work was part of a Ph.D. conducted in the University Paris 6, and I thank S. Wenz (Paris), P. L. Forey (London), M. Martin (Boulogne-sur-mer) for their critical review of the text. I am grateful to G. Arratia (Berlin) and T. B urgin (St Gallen) for reviewing the manuscript. Thanks are due to the following persons for permission to study material under their care: S. Wenz and D. Goujet (MNHN, Paris), O. Glaizot (MZL, Lausanne) and A. Blanco (Li ares, Mexico). I am very much indebted to Jill Hall (MDE, Esp eraza) for improving the English. This research was supported by the Swiss National Science Foundation (grant n  8220-56521).

## REFERENCES

- ARAMBOURG, C. 1954: Les poissons cr tac s du Jebel Tselfat (Maroc). Notes et M moires 118, 1-188.
- ARRATIA, G. 1981: *Varasichthys ariasi* n. gen. et sp. from the Upper Jurassic of Chile (Pisces, Teleostei, Varasichthyidae n. fam.). *Palaeontographica Abt. A* 175 (4-6), 107-139.
- 1997: Basal Teleosts and teleostean phylogeny. *Palaeo Ichthyologica* 7, 5-168.
- 1999: The monophyly of Teleostei and stem-group teleosts. Consensus and disagreements. In: *Mesozoic Fishes 2 - Systematics and Fossil Record* (Ed. by ARRATIA, G. & SCHULTZE, H.-P.). Verlag Dr. Friedrich Pfeil, M nchen, 265-334.
- & CHORN, J. 1998: A new primitive acanthomorph fish from the Greenhorn Formation (Late Cretaceous) of Nebraska. *J. Vertebrate Paleontology* 18 (2), 301-314.
- & LAMBERS, P. 1996: The caudal skeleton of Pachycormiforms: Parallel evolution?. In: *Mesozoic Fishes 2 - Systematics and Fossil Record* (Ed. by ARRATIA, G. & SCHULTZE, H.-P.). Verlag Dr. Friedrich Pfeil, M nchen, 191-218.
- & SCHULTZE, H.-P. 1985: Late Jurassic Teleosts (Actinopterygii, Pisces) from Northern Chile and Cuba. *Palaeontographica Abt. A* 189 (1-3), 29-61.
- BARDACK, D. & TELLER-MARSHALL, S. 1980: *Tselfatia*, a Tethyan Cretaceous teleost: first records from North America and Yugoslavia. *J. of Paleontology* 54 (5), 1075-1083.
- BRAVI, S. 1995: Studies on old and new Meso-Cenozoic "Plattenkalk" in Southern Italy. II International Symposium on Lithographic Limestones, Lleida-Cuenca (Spain).
- CAVIN, L. 1995: *Goulmimichthys arambourgi* n. g., n. sp., un Pachyrhizodontidae (Actinopterygii, Teleostei) d'une nouvelle localit    nodules fossilif res du Turonien inf rieur marocain. *C. R. Acad. Sci., Paris t. 321* (ser. II a), 1049-1054.
- 1997: Nouveaux teleostei du gisement du Turonien inf rieur de Goulmima (Maroc). *C. R. Acad. Sci., Sci. Terre et Plan tes* 325, 719-724.
- 1999: Occurrence of a juvenile teleost, *Enchodus* sp., in a fish gut content from the Upper Cretaceous of Goulmima, Morocco. *S. P. in Palaeontology* 60, 57-72.
- Les poissons t l ost ens du Turonien suppos  de la C te Sainte-Catherine (Rouen, France) conserv s au Mus um d'Histoire naturelle de Rouen. *Bull. Soc. Hist. Nat., Elbeuf*. In press a.
- Effects of the Cretaceous-Tertiary event on bony fishes. *Lecture Notes in Geology*. In press b.
- & P. L. FOREY. 2001: Osteology and systematic affinities of *Palaeonotopterus greenwoodii* Forey, 1997 (Teleostei: Osteoglossomorpha). *J. Linn. Soc.* 132, 1-28.
- CHANET, B. 1997: Plethodid remains (Osteichthyes: Teleostei incertae sedis) from the basal Albian of the Vocontian basin (S. E. France). *N. Jh. Geol. Pal ont., Mh* 1997 (11), 696-702.
- COPE, E. D. 1872: Observations on the systematic relations of the fishes. *Proc. Amer. Assoc. for the Advancement of Sci.* 1871, 317-343.
- DUBAR, G. 1949: Carte g ologique provisoire du Haut Atlas de Midelt,  chelle au 1/200 000. Notice explicative, Notes et M moires, 59bis, 1-60.
- FIELITZ, C. & SHIMADA, K. 1999: A new species of *Bananogmius* (Teleostei: Tselfatifformes) from the Upper Cretaceous Carlisle shale of Western Kansas. *J. of Paleontology* 73 (3), 504-511.
- FOREY, P. L. 1973: A revision of the Elopiform Fishes. *Fossil and Recent. Bull. Br. Mus., Nat. Hist. (Geol.) suppl.* 10, 1-222.
- 1977: The osteology of *Notelops* WOODWARD, *Rhacolepis* AGASSIZ and *Pachyrhizodus* DIXON (Pisces: Teleostei). *Bull. Br. Mus., Nat. Hist. (Geol.)* 28 (2), 125-204.
- LITTLEWOOD, D. T. J., RITCHIE P. & MEYER, A. 1996: Interrelationships of Elopomorph Fishes. In: *Interrelationships of Fishes* (Ed. by STIASNY, M. L. J., PARENTI, L. R. & JOHNSON, G. D.). Academic Press, 175-191.
- GOODY, P. C. 1969: The Relationships of certain Upper Cretaceous Teleosts with special Reference to the Myctophoids. *Bull. Br. Mus., Nat. Hist. (Geol. Suppl. 7)*, 1-255.
- GRANDE, L. & BEMIS, W. E. 1998: A Comprehensive Phylogenetic Study of Amiid Fishes (Amiidae) Based On Comparative Skeletal Anatomy. An Empirical Search for Interconnected Patterns of Natural History.- *Suppl. J. of Vert. Palaeontology, Memoir* 4, 18 (1), 1-690.
- GRANDE, T. & POYATO-ARIZA, F. J. 1999: Phylogenetic relationships of fossil and Recent gonorynchiform fishes (Teleostei: Ostariopysi). *Zool. J. Linn. Soc.* 1999 (125), 197-238.
- GREENWOOD, P. H. 1970: skull and swimbladder connections in fishes of the family Megalopidae. *Bull. Br. Mus. Nat. Hist., (Zool)* 19 (3), 119-135.
- JOHNSON, G. D. & PATTERSON, C. 1993: Percomorph phylogeny: a survey of Acanthomorphs and a new proposal. *Bull. of marine Science* 52 (1), 554-626.
- & - 1996: Chapter 12. Relationships of Lower Euteleostean Fishes. In: *Interrelationships of Fishes* (Ed. by STIASNY, M. L. J., PARENTI, L. R. & JOHNSON, G. D.). Academic Press, 251-332.
- LERICHE, M. 1929: Les Poissons du Cr tac  marin de la Belgique et du Limbourg hollandais (Note pr liminaire). *Bull. Soc. belge de g ol. de pal. et d'hydro* 37, 199-299.
- LI, G. Q. & WILSON, M. V. H. 1996: The discovery of Heterotidinae (Teleostei: Osteoglossidae) from the Paleocene Paskapoo Formation of Alberta, Canada. *J. of Vert. Pal.,* 16 (2), 198-209.
- MAISCH, M. W. & LEHMANN, J. 2000: *Tselfatia formosa* Arambourg, 1943 (Teleostei) from the Upper Cretaceous of Lower Saxony (Northern Germany). *N. Jb. Geol. Pal ont. Mh.,* 2000 (8), 499-512.
- MAISEY, J. G. 1991a: *Notelops* WOODWARD, 1901. In: *Santana fossils. An illustrated Atlas* (ed. by MAISEY J. G.). t.f.h. Publications, 258-271.
- 1991b: *Rhacolepis* AGASSIZ, 1841. In: *Santana fossils. An illustrated Atlas* (ed. by MAISEY J. G.). t.f.h. Publications, 110-115.
- 1999: The supraotic Bone in Neopterygian Fishes (Osteichthyes, Actinopterygii). *Am. Mus. Novitates* 3267, 1-52.
- & BLUM, S. 1991a: *Paraelops* SILVA SANTOS, 1971 In: *Santana fossils. An illustrated Atlas* (ed. by MAISEY J. G.). t.f.h. Publications, 238-247.
- & BLUM, S. 1991b: *Araripichthys* SILVA SANTOS, 1985 In: *Santana fossils. An illustrated Atlas* (ed. by MAISEY J. G.). t.f.h. Publications, 208-217.
- MONOD, T. 1968: Le complexe urophore des Poissons T l ost ens. *M m. Inst. Fondamental Afr. noire* 81, 1-679.
- NELSON, G. J. 1973a: Relationships of clupeomorphs, with remarks on the structure of the lower jaw in fishes. In: *Interrelationships of Fishes* (Ed. by GREENWOOD, P. H., MILES, R. S. & PATTERSON, C.). *Zool. J. Linn. Soc., Suppl.* 1, 53, 333-349.
- 1973b: Notes on the Structure and Relationships of Certain Cretaceous and Eocene Teleostean Fishes. *Am. Mus. Novitates* 2524, 1-31.
- NYBELIN, O. 1956: Les canaux sensoriels du museau chez *Elops saurus* (L.). *Arkiv f r Zoologi* 10(9): 453-458.
- 1960: A gular plate in *Albula vulpes* (L.). *Nature* 188 (4744), 78.
- 1968: The dentition in the mouth cavity of *Elops*. *Nobel Symposium* 4, Current Problem of Lower Vertebrate Phylogeny.
- 1971: On the Caudal Skeleton in *Elops* with Remarks on Other Teleostean Fishes. *Acta Regiae Societatis Scientiarum et Litterarum Gothoburgensis, Zoologica* 7, 1-52.

- 1974: A revision of the Leptolepid Fishes. Acta Regiae Societatis Scientiarum et Litterarum Gothoburgensis, Zoologica 9, 1–202.
- PARAMO-FONSECA, M. E. 1997: *Bachea huilensis* no. gen., nov. sp., premier Tselfatioidei (Teleostei) de Colombie. C. R. Acad. Sci., Paris 325, 147–150.
- PATTERSON, C. 1964: A Review of Mesozoic Acanthopterygian Fishes, with special Reference to those of the English Chalk. Phil. Trans. Roy. Soc., London 247 (739), 213–482.
- 1967: A second specimen of the Cretaceous teleost *Protobrama* and the relationships of the sub-order Tselfatioidei. Arkiv för Zoologi 19 (8), 215–234.
- 1968: The caudal skeleton in Mesozoic Acanthopterygian. Bull. Br. Mus. nat. Hist. (Geol) 19, 49–102.
- 1993a: Osteichthyes: Teleostei. In: Fossils Record 2 (Ed. by BENTON M. J.), Chapman & Hall, London, 621–656.
- 1993b: An overview of the early fossil record of Acanthomorphs. Bull. of marine Science 52 (1), 29–59.
- & ROSEN, D. E. 1977: Review of Ichthyodectiform and other Mesozoic Teleost Fishes and the Theory and Practice of Classifying Fossils. Bull. Amer. Mus. Nat. Hist. 158 (2), 83–172.
- SILVA SANTOS, R. DA. 1985: *Araripichthys castilhoi* novo gênero e espécie de Teleostei da Formação Santana, Chapada do Araripe, Brasil. Colet. trab. Paleont. brasil., D. N. P. M. 1985, 133–139.
- SORBINI, L. 1976: L'ittiofauna Cretacea di Cinto Euganeo (Padova-Nord Italia). Boll. Mus. Civ. St. Nat. Verona 3, 479–567.
- TAVERNE, L. 1973: Sur la position systématique et les affinités de *Greenwoodella tockensis* TAVERNE, L. et ROSS, P. H. 1973 (Pisces Elopiformes) de l'Aptien inférieur de l'île d'Helgoland (Allemagne). Bull. Inst. Roy. Sci. nat. Belg. 49 (9), 1–6.
- 1974: L'ostéologie d'*Elops* LINNE, C., 1766 (Pisces Elopiformes) et son intérêt phylogénétique. Acad. Roy. Belg., Mém. Cl. Sc., Bruxelles, 2e sér. 61 (2), 1–96.
- 1975: A propos de *Tselfatia* ARAMBOURG, C., 1943 (Cénomaniens du Maroc), de *Protobrama* WOODWARD, A. S., 1942 (Cénomaniens du Liban) et du rapport éventuel des Tselfatioïdes fossiles (Crétacé) et des Téléostéens du super-ordre des Ostéoglossomorphes. Ann. Soc. Roy. Zool. Belg. 105 (1–2), 53–72.
- 1976a: A propos du poisson fossile *Notelops brama* (AGASSIZ, L., 1841) du Crétacé inférieur du Brésil et de sa position systématique au sein des téléostéens primitifs. Biol. Jb. Dodonaea 44, 304–310.
- 1976b: A propos d'*Elopopsis microdon* Heckel, J. J., 1856, du Crétacé moyen d'Afrique et d'Europe et des affinités systématiques de la famille fossile des Pachyrhizodontidae au sein des Téléostéens primitifs. Rev. Zool. afr. 90(2), 487–496.
- 1980: Ostéologie et position systématique du genre *Platinx* (Pisces, Teleostei) de l'éocène du Monte Bolca (Italie). Acad. Roy. Belg., Mém. Cl. Sc., 66 (5), 873–889.
- 1981: Les Actinoptérygiens de l'Aptien Inférieur (Töck) d'Helgoland. Mitt. Geol.-Paläont. Inst. Univ. Hamburg 51, 43–82.
- 1983: Ostéologie et affinités systématiques de *Tselfatia formosa*, Téléostéen fossile du Crétacé supérieur de la Mésogée eurafricaine. Anns. Soc. r. zool. Belg. 113 (2), 165–181.
- 1987: On the cranial and caudal osteology of the Cretaceous marine Teleost *Pachyrhizodus* (Pachyrhizodontidae, Crossognathiformes). Biol. Jb. Dodonaea 55 (1), 136–145.
- 1989: *Crossognathus* PICTET, 1858 du Crétacé inférieur de l'Europe et Systématique, Paléozoogéographie et Biologie de Crossognathiformes nov. ord. (Téléostéens) du Crétacé et du Tertiaire. Palaeontographica Abt. A 207(1–3), 79–105.
- 1991: *Greenwoodella tockensis* TAVERNE and ROSS, 1973 from the Marine Lower Aptian (Töck) of Helgoland (West Germany), the Oldest Known Pachyrhizodontid Fish (Teleostei, Crossognathiformes). Geol. Jb. A 120 (2), 305–309.
- 1993: Ostéologie et affinités du téléostéen crétacique *Elopopsis microdon* (Pisces, Crossognathiformes, Pachyrhizodontidae). Biol. Jb. Dodonaea 61, 172–192.
- 1996: Révision de *Tingitanichthys heterodon* (ARAMBOURG, 1954) nov. gen. (Teleostei, Pachyrhizodontoidei) du Crétacé supérieur marin du Maroc. Biol. Jaarb. Dodonaea 63, 133–151.
- 1999: Révision de *Zanclites xenurus*, téléostéen (Pisces, Tselfatiiformes) marin du Santonien (Crétacé supérieur) du Kansas (Etats-Unis). Belg. J. Zool. 129 (2), 421–438.
- 2000a: *Tselfatia formosa*, téléostéen marin du Crétacé (Pisces, Actinopterygii), et la position systématique des Tselfatiiformes ou Bananogmiiformes. Geodiversitas 22 (1), 5–22.
- 2000b: Ostéologie et position systématique du genre *Plethodus* et des nouveaux genres *Dixonanogmius* et *Pentanogmius*, poissons marins du Crétacé (Teleostei, Tselfatiiformes). Biol. Jaarb. Dodonaea 67 (1), 94–123.
- 2000c: *Eoplethodus chaneti* gen. et sp. nov. de l'Albien (Crétacé) marin de Provence (France) et l'évolution du squelette caudal chez les Tselfatiiformes (Osteichthyes: Teleostei). Cybium 24 (4), 371–381.
- 2000d: Révision du genre *Martinichthys*, poisson marin (Teleostei, Tselfatiiformes) du Crétacé supérieur du Kansas (Etats-Unis). Geobios 33 (2), 211–222.
- 2001: Révision du genre *Bananogmius* (Teleostei, Tselfatiiformes), poisson marin du Crétacé supérieur d'Amérique du Nord et d'Europe. Geodiversitas 21 (1), 17–40.
- TELLER-MARSHALL, S. & BARDACK, D. 1978: The Morphology and Relationships of the Cretaceous Teleost *Apsopelix*. Fieldiana Geology 41 (1), 1–35.
- WENZ, S. & FRICOT, C. 1985: Présence de *Pachyrhizodus salmoneus* (Günther), Pisces, Teleostei, Pachyrhizodontidae, dans l'Albien moyen de l'Aube (France). Bull. info. Géol. Bassin de Paris 22 (4), 7–10.
- WIFFEN, J. 1983: The first record of *Pachyrhizodus caninus* COPE (Order Clupeiformes) from the Late Cretaceous of New Zealand. New Zealand Journal of Geology and Geophysics 26, 109–119.
- WILEY, E.O., SIEGEL-CAUSEY, D., BROOKS, D. R. & FUNK, V. A. 1991: The complete cladist. A primer of phylogenetic procedures. The Uni. Kansas, Mus. Nat. Hist. S. P. 19, 1–158.

Manuscript received 20 February, 2001

Révision accepted 20 July, 2001

