

**Zeitschrift:** Bulletin des Schweizerischen Elektrotechnischen Vereins  
**Herausgeber:** Schweizerischer Elektrotechnischer Verein ; Verband Schweizerischer Elektrizitätswerke  
**Band:** 40 (1949)  
**Heft:** 17

**Artikel:** Problems of theatre large screen television projection  
**Autor:** West, A.G.D.  
**DOI:** <https://doi.org/10.5169/seals-1060693>

### **Nutzungsbedingungen**

Die ETH-Bibliothek ist die Anbieterin der digitalisierten Zeitschriften. Sie besitzt keine Urheberrechte an den Zeitschriften und ist nicht verantwortlich für deren Inhalte. Die Rechte liegen in der Regel bei den Herausgebern beziehungsweise den externen Rechteinhabern. [Siehe Rechtliche Hinweise.](#)

### **Conditions d'utilisation**

L'ETH Library est le fournisseur des revues numérisées. Elle ne détient aucun droit d'auteur sur les revues et n'est pas responsable de leur contenu. En règle générale, les droits sont détenus par les éditeurs ou les détenteurs de droits externes. [Voir Informations légales.](#)

### **Terms of use**

The ETH Library is the provider of the digitised journals. It does not own any copyrights to the journals and is not responsible for their content. The rights usually lie with the publishers or the external rights holders. [See Legal notice.](#)

**Download PDF:** 03.04.2025

**ETH-Bibliothek Zürich, E-Periodica, <https://www.e-periodica.ch>**

auch die Grösse der Apparatur mehr oder weniger vollständig bestimmt.

Auf Grund ausgedehnter theoretischer Bearbeitung und nach Überwindung grosser technologischer Schwierigkeiten ist es gelungen, an Hand einer Versuchsapparatur die Erkenntnisse zu erhärten und zu erproben. Die Arbeiten an der Versuchsanlage sind erst vor kurzem soweit gediehen, um Fernsehbilder übertragen zu können. Ich möchte an dieser Stelle allen denjenigen danken, welche den Glauben an die Erreichung des Zieles nie aufgegeben haben. Im weiteren gebührt allen

Mitarbeitern grosser Dank, welche sich unermüdet und mit grosser Hingabe der Überwindung mannigfacher Schwierigkeiten gewidmet haben. Nicht zuletzt haben sämtliche Mitglieder der Gesellschaft zur Förderung der Forschung an der ETH durch ihre finanzielle Unterstützung dazu beigetragen, die Entwicklungsarbeiten überhaupt zu ermöglichen.

Adresse des Autors:  
Dr. H. Thiemann, Sektionschef, Abteilung für Industrielle Forschung des Institutes für Technische Physik an der Eidgenössischen Technischen Hochschule, Gloriastr. 41, Zürich 6, Schweiz.

## Problems of Theatre Large Screen Television Projection

By A. G. D. West, London

621.397.62 : 778.5

This paper presents a British point-of-view in relation to the practical application of Large Screen Television to theatre entertainment.

### Requirements for a Theatre Service

It is the ultimate aim of the television engineer to provide the entertainment industry with a complete television system which can handle and distribute all types of programme material which will be of interest. The system and the equipment utilized therein, can conveniently be divided up as follows:

- a) Pick-up equipment consisting of cameras and associated equipment for synchronising control for interior (such as studio and dramatic presentations) and for exterior (outdoor scenes) together with the necessary sound pick-up, lighting and power supply.
- b) Film scanning equipment.
- c) Control room equipment, for the purpose of selection and routing of programmes.
- d) Distribution network, utilising special cables or high frequency radio channels.
- e) Theatre television projectors and loud speakers.

Fig. 1 (a charter or ideal for British theatre television engineers) indicates a possible system of pick-up control, distribution, and theatre reproduction which is capable of dealing with events taking place mainly in the London area, and of distribution not only to theatres in London but to theatres in the provinces also. At the same time it comprises provincial programme sources also.

Progress has been concentrated under all the above headings, and will continue until there is evolved a satisfactory system which exhibitors will welcome as a valuable contribution towards their theatre entertainment. The aim of the technician, who is primarily concerned with this aspect of television, will be to secure perfection independently in each of the divisions of work enumerated above. The overriding problem is of course:

*The development of theatre television projection to a form comparable to the present-day film projection.*

Such a programme of work can conveniently be visualised in two stages:

1. The attainment of the utmost possible performance in each link of the 405- or 525-line system; alternatively the maximum possible to the 3 megacycle bandwidth limit.

2. The full equivalent to film projection (say 1000-line basis or 20 megacycles bandwidth, or whatever it may be found to be).

The exhibitor or promoter is our customer, and he *presumably* is capable of visualising a true representation of what the public will require. It is our duty to satisfy him by providing:

*First:* Instantaneous projection in theatres, from a given distribution centre, of items of entertainment, interesting events and actualities.

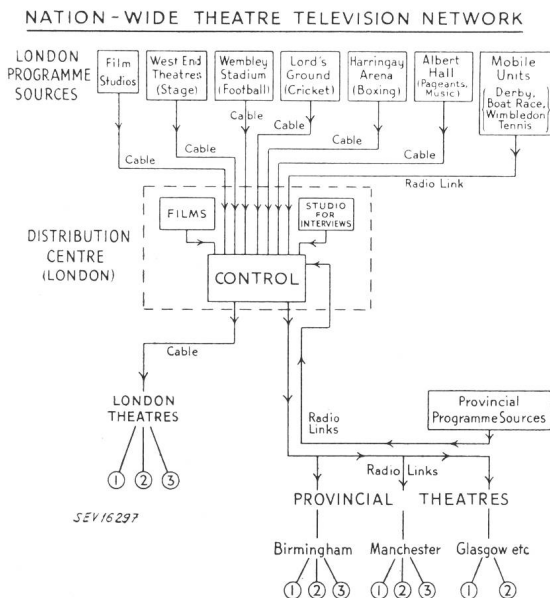

Fig. 1  
Proposal for Nation-Wide Theatre Television Network

*Secondly:* Delayed presentation from the distribution centre. For example, daily films of local interest which are applicable to the theatres in a local area.

*Thirdly:* Delayed presentation in individual theatres where the programme planning is impracticable to admit of instantaneous projection, or requires presentation additional to that given by instantaneous projection.

All these needs must be provided with the qualities of normal film projection.

Fig. 2 illustrates the electronic method of instantaneous projection and the intermediate film method of delayed projection.

During recent years, we have seen the development and application of many new types of equipment which have an important bearing on our work. For example, new types of television cameras, of scanners for film and still pictures, new means of

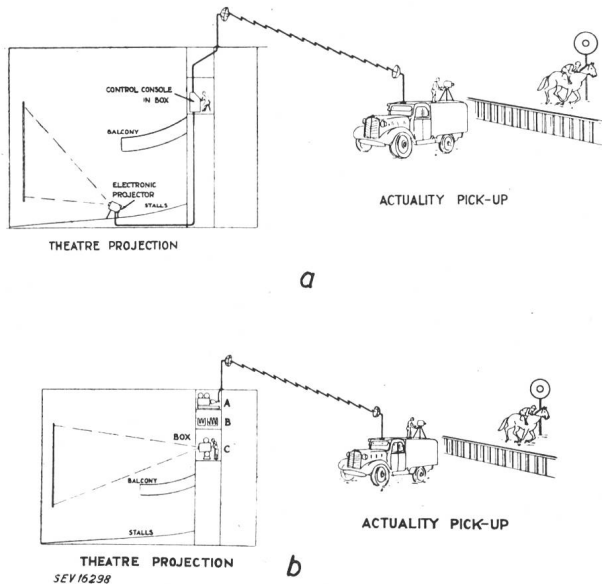

Fig. 2  
 a Large Screen Projection by instantaneous electronic film process  
 b By intermediate film process  
 Television picture recorded on film at A  
 Film processed and dried at B  
 Film projected by normal projector at C

distribution by radio or by cable, and theatre projectors either of the cathode-ray-tube type with lens and mirror systems or of the intermediate film type, or of the storage type.

*Comparison with Cinema Standards*

Before considering these in detail, I should like to specify five main headings (which can possibly be regarded as separate factors, but which in practice are all interlinked), to provide a basis of comparison with the accepted standards of the cinema.

1. Picture definition, or detail of the reproduced picture.
2. Picture quality or faithful reproduction of the tone values, from black through the half-tones to white.
3. Brightness of the reproduced picture, and its colour.
4. Freedom from interference, flicker, spurious patterns and effects, shading and background noises.
5. Cost of manufacture of the equipment and of its installation and maintenance.

*Performance of Equipment*

Let us now make a brief review of the various types of equipment already developed on either side of the Atlantic, demonstrated in England, and also able to be manufactured.

a) *Cameras.* You are quite familiar with the operation and characteristics of the various types of television cameras, so I need not go into them in

detail, except to say that with the Iconoscope we acknowledge its superiority in definition, but also its limitation in the production of undesired shading effects which cannot be controlled. The Image Iconoscope has the advantage of a little more sensitivity than the Iconoscope and less shading troubles. The Orthicon with its even field of picture rendering is free from shading, but loses detail; and the Image Orthicon with its enormously increased sensitivity, suffers however from background noise and great difficulties in manufacture.

b) *Film Scanners.* There are those, like the Mechau continuous motion mechanism, which use the Iconoscope, and therefore suffer from distortions of the picture gradation. There is the Farnsworth dissector film scanner which we have seen described and demonstrated at this Conference. And finally, there is the cathode ray tube flying spot scanner, which can give under controlled conditions, as good a picture as you would wish to see, with excellent definition and quality, and free from shading.

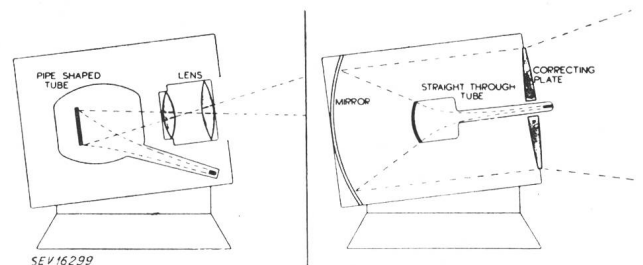

Fig. 3  
 Lens and Mirror Electronic Projectors

c) *Caption or Still Picture Scanners.* The same remarks apply.

d) *Means of Distribution.* By Radio Links, which can carry the full requirement of frequency range, which are flexible in setting up and operation, but which may be subject to interference. By Cable, with limited frequency band and high capital cost.

e) *Projection.* Cathode-ray-tube Projectors, either using a wide aperture anastigmatic lens or a Schmidt mirror system (fig. 3). Intermediate Film Projectors, in the operation of which much experience still is to

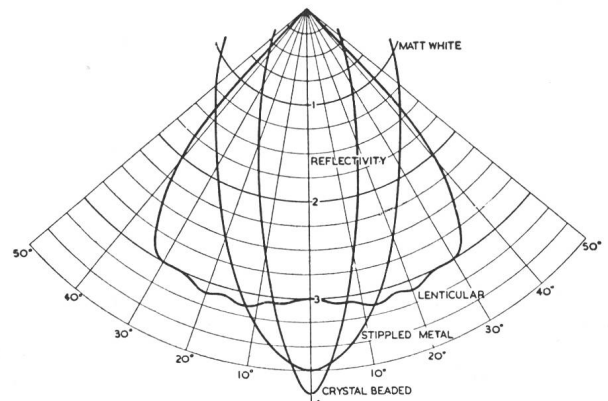

Fig. 4  
 Polar diagrams

showing reflectivity of types of screens at various angles with the normal to the screen, compared with that of the matt white screen which is represented by the circle of radius 1

be gained. Storage Projectors, of which only one type so far has been shown to be practicable, namely the AFIF system developed by Professor Fischer.

f) *Screens.* Types of screens with higher reflection co-efficients than the normal matt white screen, such as the established types of beaded or silver screens; new types of screens coated with material which is a combination of matt white and silver; and lenticular types of screens varying from the

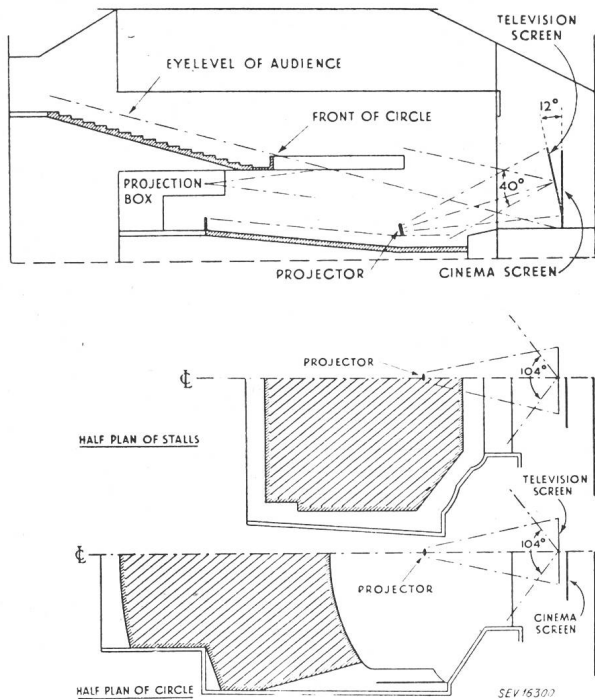

Fig. 5

An elevation and plan of an average theatre showing the angle required for screen reflection in the vertical and horizontal planes

crudely stippled metal screens to the optically designed lenticular screens which project all the received light back into the audience seating only (fig. 4). A screen having a reflecting cone with a vertical angle of  $40^\circ$  and a total horizontal angle of  $104^\circ$  would be ideal for the average theatre (fig. 5).

Arising out of the consideration of the qualities of the various types of equipment referred to (lack of time prevents me from going into a detailed study), we have in my Company evolved an experimental 405-line system which has already been the subject of practical tests, and which for the present consists of:

- Telecameras — The image orthicon, or image iconoscope.
- Telecine — C.R.T. flying spot film scanner (fig. 6).
- Telecaption — C.R.T. flying spot still picture scanner.
- Teledistribution — Radio links operating with a few watts on a frequency of 480 Mc./s at distances up to 30 miles.
- Tele-projectors — A Schmidt mirror projector having a 27" diameter mirror, and an 18" diameter plastic correcting plate; with an aluminium backed straight through cathode-ray-tube, operating on an anode voltage of 50 000; mounted in the stalls, or on the front of the balcony; remotely controlled

from a console installed at the back of the stalls or in the projection box (fig. 7, 8, 9 and 10).

Alternatively, an intermediate film projector with a rapid pull-through camera recorder and a processing delay time of 90 seconds.

Theatre Screens— Of a type where the reflected light is concentrated into the area occupied by the audiences.

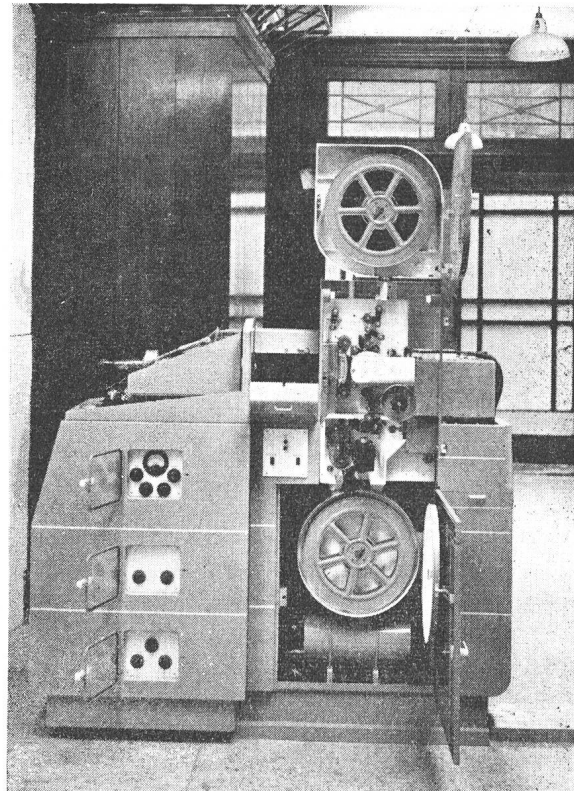

Fig. 6

«Cintel» flying-spot (35 mm) film scanner with doors open and cover removed  
Scanning Tube on left, Optical System, Gate, and Photo-cell in centre

I must now state the practical results achieved in terms of the fundamental points of performance which I have specified above.

1. The *definition* over the whole system is such that 3 mega-cycle vertical bars are resolved in the picture without any noticeable phase defects.

2. The measured highlight *brightness* on a  $16' \times 12'$  (5 m  $\times$  4 m) screen in the direction normal to the screen down the centre line of the theatre, is 8 ft. lamberts, compared with the accepted film projection standard of 7—14 ft. lamberts (projector running with no film in the gate) and the measured black brightness is 0.1 ft. lamberts; the average contrast range during a succession of pictures is 50:1. At  $30^\circ$  off the centre line the highlight brightness is 5 ft. lamberts. The output of light from the projector with no picture, and running at a brightness corresponding to the maximum usable highlight brightness for a good quality picture is 800—1000 lumens. This question of lumens always causes difficulties of comparison in various countries. Whether it is due to Fog in London, or Humidity in New York, or the Warmth of Atmosphere (technically as well as socially) in Zurich, there is no doubt that the lumen is different in the three countries. Perhaps it is due to variations in the quality of the wax used to manufacture the standard candle.



However, in our own case we find the following confirmations of our conclusions in respect of this new projector:

(i) By brightness measurement:

8 ft-lamberts on a 2:1 reflecting screen is equivalent to 4 ft-candles illumination. On a screen 16 ft. × 12 ft. the  $Flux = 4 \times 16 \times 12 = 800$  lumens.

$$\begin{aligned} Flux &= \left( 50\,000 \times \frac{5}{1000} \times 5 \right) \times \frac{3}{4} \times \frac{1}{(1)^2} \\ &= \frac{1250 \times 3}{4} = \frac{3750}{4} = 900 \text{ lumens approximately.} \end{aligned}$$

To continue, the colour of the picture is black and white. Fig. 11 indicates the progress of definition and brightness over

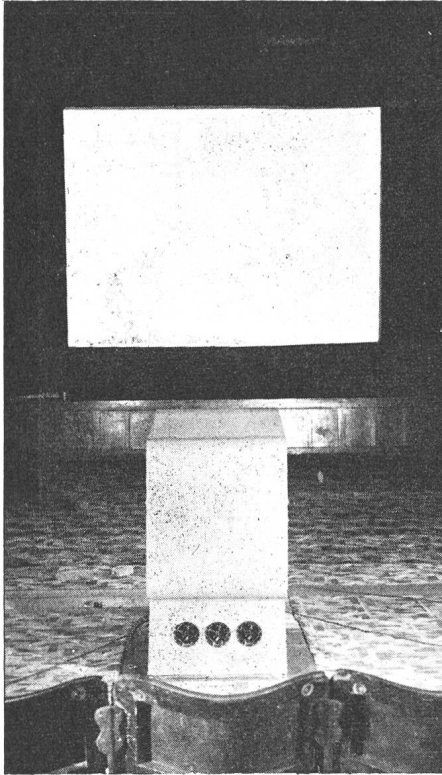

Fig. 7

«Cintel» mirror projector installed at the Palais-de-Luxe Cinema, Bromley  
Rear view

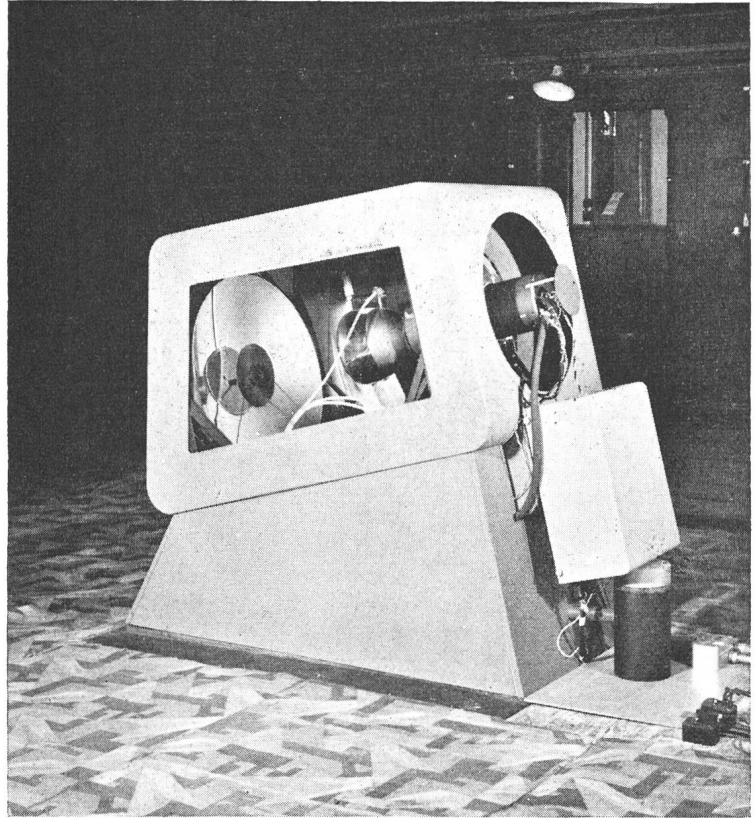

Fig. 8

«Cintel» 27 in. mirror projector for 16- by 12-foot screen  
Front view

(ii) By computation:

$$\begin{aligned} Flux &= \text{Luminous Intensity} \times \text{Solid angle.} \\ &= (\text{Power} \times \text{Luminous Efficiency}) \times \text{Solid Angle.} \\ &= (\text{Voltage} \times \text{Current} \times \text{Efficiency}) \times \frac{\pi}{4} \frac{1}{(\text{aperture})^2} \end{aligned}$$

With 50 000 volts and 5 milliamperes in the cathode ray beam, and efficiency of 5 candles per watt, and aperture of 0.8, say 1.0,

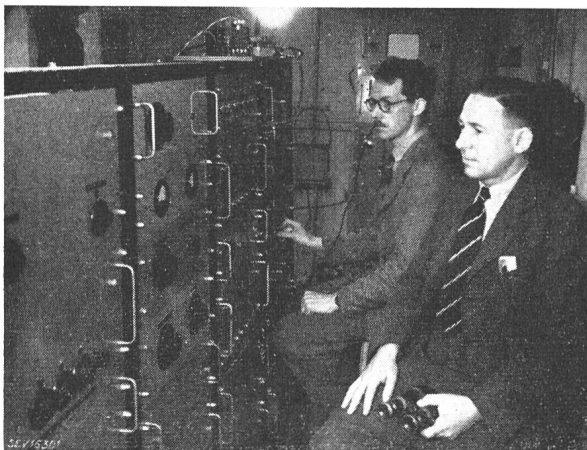

Fig. 9

Remote control box for the operation of the 27" mirror projector

the years, in comparison with the desirable results which are equivalent to the average characteristics of film projection in theatres. The important point about these curves is that the upward tendency continues and there is no sign yet of a slowing up of progress, which might be indicated by a flattening of the curves.

3. The estimated *overall quality* curve is approximately linear over the range from black to two-thirds the highlight brightness specified in 2 above, and tends to flatten out above that figure.

This distortion has now been mostly made good to provide an overall constant gamma condition.

4. With regard to *freedom from interference*, I must admit that there is much to be desired with existing standards, and with relatively uncontrolled local noises. Under the best conditions these can be a relatively unimportant factor, but on occasions the interference may be troublesome and cause annoyance to the spectator. But as time goes on, the situation gradually improves, and no doubt, in course of time, with education and possibly legal action to regulate the sins of radiation of motorists and diathermists, we shall have a relatively noise free ether.

#### *Proposals for an Experimental System for the London Area*

The complete system which I have described above, and which is in practical operation in an experimental form, and will be engineered in a form suitable for the production of a serviceable instru-

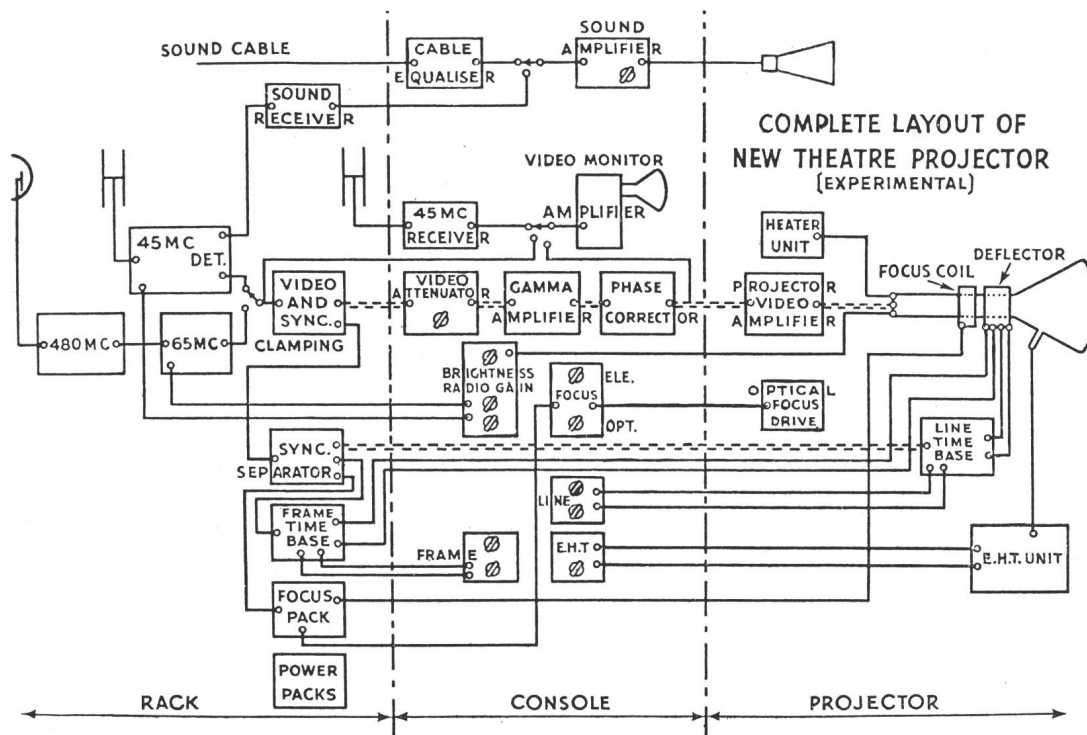

Fig. 10  
Block diagram showing three main units of «Cintel» 1947 theatre projector, capable of operating off cable input, and off 45- and 480-Mc./s radio inputs

ment, is, a first practical solution which we can offer to the cinema interests. (It is, of course, a long way ahead of the equipment which was installed in six London theatres in 1939). It is up to them to decide how, where and when, they can use it to advantage.

Our programme is to set up a *sample* or experimental system in daily operation for invited and

Crystal Palace site on the southern side overlooking London, where we shall set up a central receiving station and re-transmitting station, and some local scanners for the transmission of films, interviews and announcements. The radio links will be on frequencies just above and below 480 megacycles. Re-transmissions will be beamed, from the Crystal Palace, with an angle of 10° in the direction of certain theatres which are suitable for the installation of the projection equipment. We have in mind four West End theatres and two suburban theatres. One beam will suffice to cover the London West End cinemas, and a selected north-western suburban cinema, and another beam will cover a suburban cinema in the south-eastern area of London.

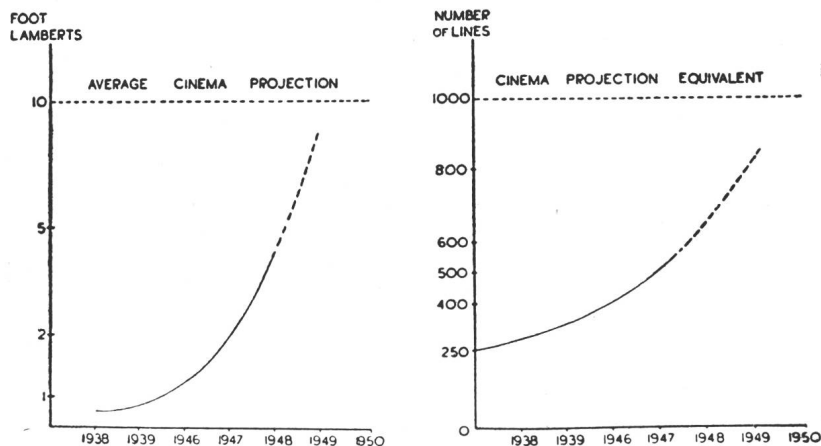

Fig. 11  
Progress of brightness and equivalent definition in large-screen (16- by 12-foot) television projection

paying audiences. Fig. 12 illustrates a plan of a proposed experimental system which we hope to complete in London during 1948 to give us this experience. You will see that programmes are to be provided from three centres — the B.B.C. Studios at Alexandra Palace in the north of London, the Pinewood Film Production Studios of the Rank Organisation to the west of London, and the

Fig. 13 and 14 are elevations of two of the selected cinemas showing our proposals for equipping them.

*Audience Reaction*

So far, nothing has yet been done, as far as I know, on either side of the Atlantic, which would give the exhibitor some practical figures and experience to gauge future public requirements. We

badly need experience on public reaction for a regular service beyond the stage when television is just a novelty and only used on special occasions.

of the installation of television equipment, and in such a form (I would say without malice aforethought) that would make it quite impossible to install television in cinemas. For example, the draft stipulates that a television projector set up in the theatre must be completely surrounded by 14" brick walls without any doors. We have visions of the projectionist being built in with the projector and remaining there all the rest of his life. But I must admit that the authorities are, however, open to suggestions for improvements in the regulations.

In actual practice, we have never had any difficulty in satisfying local authorities from the points-

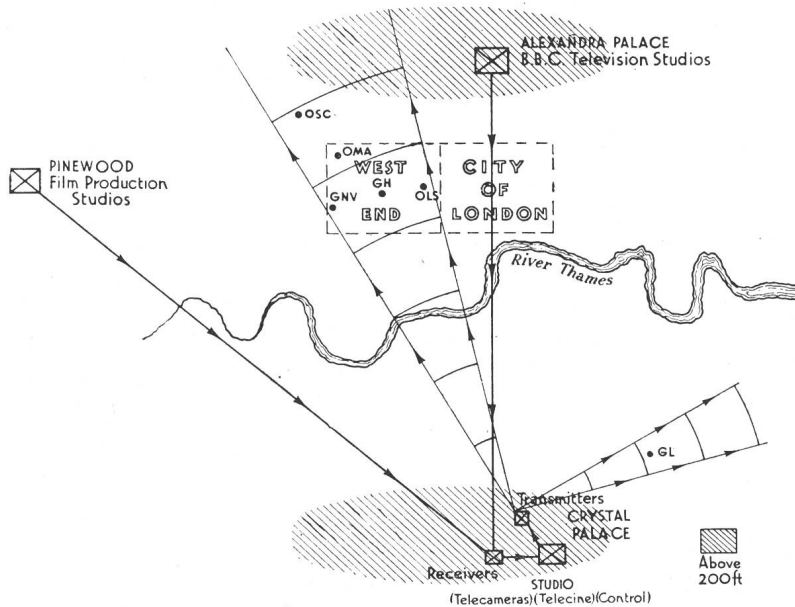

Fig. 12  
Proposed experimental kinema-television-distribution plan in the London area For 1948

*Installation and Regulations*

Finally, there is one factor not to be ignored, that is the installation problem, especially in relation to national or local regulations which when originally framed did not envisage the use of television in theatres.

In Great Britain the authorities are busy drafting more and more new regulations, as you have probably heard. Everything has to be regulated. The

of-view of safety and fire. We have found them most co-operative and as anxious to gain experience in the new type of equipment and its installation as we have been ourselves.

**Present Problems  
(Requirements for the Immediate Future)**

I come now to a few thoughts on our present problems:

1. Technical

We have to improve detail, quality, projection brightness, and freedom from miscellaneous minor but irritating defects. I prefer to group all these points together and to refer to some of the fundamental problems associated with all of them.

a) *Number of lines for theatre standardisation*

We have seen many references to the 1000-line desirability. On the other hand, we have often heard

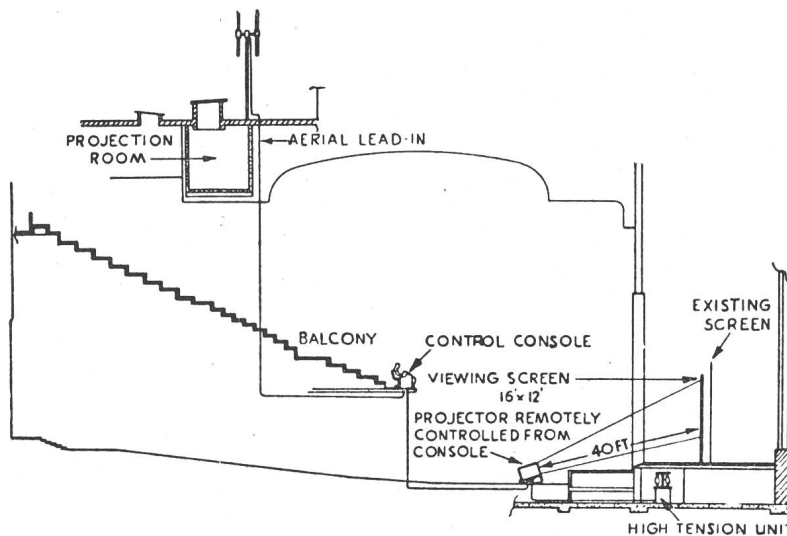

Fig. 13  
New Victoria Theatre, London  
Proposed television installation with the projector in the orchestra stalls

old original Cinematograph Act of 1909 (amended only once since that date in 1923 and before the advent of sound, and still legally in force) would close *half* the cinemas in the country if the letter of the Law were observed. A new amendment of the old Act is now in preparation, and has been drafted, and would, according to the exhibitors, close *all* cinemas. Clauses have been drafted in anticipation

that our 405-line system at its best is enough. That, of course, refers to a controlled local picture. Therefore, ignoring for the moment all the excellent work which has so far been done in trying to establish the minimum basis for either home or large screen projection, we decided to start afresh and make a practical investigation with many observers, of the brightness-resolution-contrast relationship in pro-

jected pictures. Some of the preliminary conclusions are given in fig. 15 which show the result of observations made on line patterns of various dimensions exhibiting varying degrees of contrast and illuminated at various values of brightness. The curves

to something between a 950 and 1400 line picture at a brightness of 10 ft. lamberts; but in practice, according to curve *D*, the result of observations of projected films, it is satisfied with something between a 650 and 950 line picture at that brightness. Arising from this, it appears to be desirable that we should aim at a standard of something round about 625-lines for the home, i. e. domestic television, 900-lines for theatre television, and up to 1200-lines if we wish to record a picture on film which will provide prints equivalent to normal film practice.

These are technical and not necessarily economic considerations.

*b) Systems of Scanning*

We have got too much into the way of a tacit acceptance of double interlacing, based on a theoretical calculation of its advantages. I am not at all sure that practice has proved this.

For example, many authorities have admitted, as a result of their practical experience of results using interlaced scanning, that they would prefer a 500-line sequential picture at 50 pictures per second to a 1000-line interlaced picture at 50 frames 25 pictures a second.

The following defects are observed in interlaced scanning: line crawling, interline flicker, spurious pattern flicker, line break-up on movement, pairing or loss of interlace, unequal field brightness, irregularities and irritating effects on vision, complexity of circuits and equipment.

Some of these also appear with sequential scanning with the added disadvantages, for a given channel bandwidth, of greater „lininess” and lower definition.

The list of interlacing defects is formidable, and indicates the reason for disquiet as to the future of interlacing in improved television systems. The advantages, however, in terms of improved definition, etc. are not to be lightly disregarded. The final choice—to interlace or not to interlace—cannot be decided without further observational data.

A number of various comparisons can be made, but they all re-

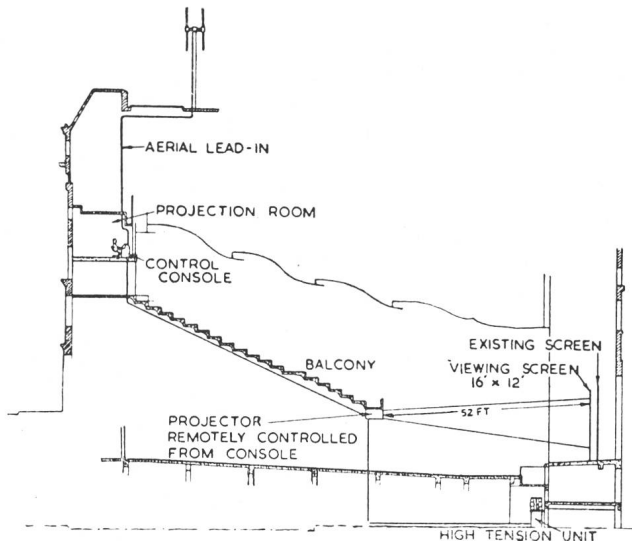

Fig. 14  
Gaumont Theatre, Haymarket, London  
Proposed television installation with the projector on the front of the balcony

in the diagram connecting brightness resolution and contrast should be taken as indicative of the order of magnitude involved where the unit of relative brightness represents the normal highlight brightness of a projected picture, say approximately 10 ft.

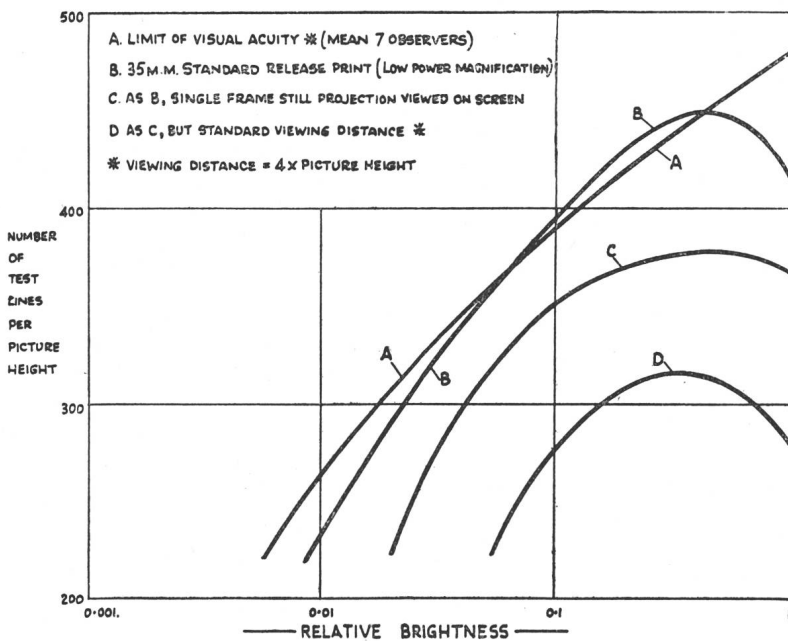

Fig. 15  
Investigation of brightness-resolution-contrast characteristics  
Data for centre of field, with low-contrast test object (Density difference 0.3, equal line width-line spacing)  
Constant «average» brightness of picture

lamberts. The number *N* of test lines per picture height is equivalent to the number *KN* of lines of television scanning, where the factor *K* lies between 2 and 3. Without going into too much detail the curve *A* indicates that the eye can appreciate up

solve themselves into a choice between either a loss of definition or the presence of flicker and stroboscopic defects. Other factors which will require attention in this investigation are the compromise between vertical and horizontal resolution,



and the value of artificial means for line broadening to reduce „lininess”.

### c) Channel Bandwidth

We have had to change our minds during the last two years regarding the amount of intelligence which can be carried on a 3 megacycle channel. Now we find that we are able to squeeze much more apparent detail and quality into a channel with a definite cut-off at 3 megacycles, and we have been remarkably surprised at the general increase of performance which has been achieved by correcting for response, phase, gamma, and other requirements throughout the whole system within this limitation of frequency. Up to now for the 1000-line transmission, the bandwidth of up to 20 megacycles has been mentioned. We believe that we shall achieve all we want to do by concentrating on obtaining the maximum value that can be obtained on a channel up to 12 megacycles only.

### d) Quality of Picture

We have been in the past, I feel, content to have seen occasionally, when all conditions were right, a picture of good quality, and then to feel that we had achieved a result which would be universally acceptable. It is only recently that a full study has been made of the component and overall linearity of the system, and that steps have been taken to correct errors in gamma. This process of gamma control, which ensures that the relative brightness of parts of the reproduced picture bear a linear relationship to the corresponding parts of the picture being scanned, is of vital importance in ensuring a picture of first-class quality. It is only when a system has been set up which complies reasonably well with this condition and registers an overall gamma roundabout 1 that one realizes the enormous improvement in general quality of the picture. As regards projection, so far no projector of any type yet complies with this condition. As I have previously mentioned, there is a distortion of the gamma curve, particularly in the highlight region, and this must be corrected, firstly, by studying each element of the system in turn, and, secondly, by applying an overall correction when each element has been improved as far as it will go.

### e) Picture Brightness

In the cathode-ray-tube projector the curve connecting brightness with anode-voltage on the cathode-ray-tube, and the curve connecting brightness with beam current, both show saturation, which begins to commence at a certain highlight brightness on the viewing screen. The problem of extending the brightness curves is one of the most important that we have at the moment. This involves the following studies:

- (i) The development of optical systems of the mirror type to even greater efficiency than the Schmidt.
- (ii) The development of tube electronic characteristics so that defocusing is controlled with an increase of voltage and current.
- (iii) The development of a fluorescent material and its application to the face of the tube, studying in particular the

problems of high current saturation, defocusing, and halation in the layer; and also its colour and life characteristics.

(iv) The development of the viewing screen providing more economical use of the light projected on to it, so that it is reflected back where it is required and not dissipated throughout the theatre.

## 2. Distribution Systems

Some considerable study has been made of the relative advantages and disadvantages of cable and radio means of distribution. On behalf of the radio link, we find lower capital and running costs, more flexibility in operation, and against it the scarcity of channels, and interference. On behalf of cable, a clear and undisturbed channel (at least we hope so), and secrecy. Against cable, the high cost of installation, resulting in high rental charges, and the length of time before the installation can be carried out, due to higher priority for installation labour.

## 3. Programme

Here we have many problems, the majority of which are outside our technical province. I have already referred to some of them. Others causing us much thought in England are as follows:

### a) Licence to operate commercially

Three years ago we asked the British Government to consider giving us facilities to operate on a commercial basis as between our studios and theatres. The permission is concerned with the means of transmission and distribution. In other words, we ask for a licence to use the ether or the facilities provided by Post Office cables. We are hoping for a decision in the very near future.

### b) Three-cornered Interests

The three interests who are mostly concerned are:

- (i) The B.B.C. and its home viewing audience.
- (ii) The promoters of sporting events, some of which can be classified as being of a national nature.
- (iii) The cinema interests.

Therefore, if these three could be got to work together in harmony, with full co-operation in the provision and exchange of programme material, the authorisation of a licence which would give the cinema interests a start in commercialising television might be forthcoming. However, pressure in this direction is bound to come when technical results are obtained, which justify in themselves that a perfected invention of this nature should be utilised for the Nation's benefit. In any case, as the price of home television receiving sets is for the time being higher than the purchase level of the majority of the population, is not television in the cinema the average man's way of participating in this form of entertainment?

### c) Place of television in the theatre programme

What do theatre interests intend to do with television? This is a question which, as I have mentioned before, needs very careful study of all factors by the entertainment industry. I have not yet heard a balanced and well thought out reply to this problem.

Are we wrong in assuming that large screen television and cinematograph projection can be made complementary to each other?

Can we show them both in the same programme?

But in the meantime, those who have financed its development must be thinking of some return. In which case, can we commercialise on an intermediate stage by either:

- (i) Provision of specialised television theatres.
- (ii) Provision of television in cinema theatres, but television and film each taking a separate and independent programme period for itself.

#### d) *Instantaneous versus delayed action*

I am not at all clear as to the relative uses of instantaneous electronic projection of television in theatres, and the delayed action presentation by using the intermediate film process. There are so many factors controlling the timing of programmes in theatres that it would be extremely difficult to guarantee that all theatres taking a particular programme would be standing by at exactly the correct moment. On the other hand, it is difficult to visualize the practical operation and maintenance of intermediate film equipment in individual theatres.

There is one thing that I am quite certain about. I have many times experienced the tenseness of an audience watching, as it is taking place, on the cinema screen, a national event, *the outcome of which is unknown*, and I am convinced of the enormous entertainment value of such an item. The satisfaction which I personally have experienced on such an occasion has been acknowledged also by all those present. The important point is that the event is being watched as it is happening, and half the entertainment value would be lost with delayed presentation.

I feel, however, that the best way out of this problem is not by writing and talking, but by

setting out to obtain practical experience in both methods over a period of time; such work to be done in close co-operation between the technicians and the leaders of the entertainment industry, and it is only by facing this problem fairly and squarely that we can really get a solution that will satisfy future requirements in the provision and extension of the cinema television service.

#### 4. General Economic Problem

Although I am not qualified to discuss this subject, I feel that this is a matter which must not be left unmentioned in a general survey of this nature.

In looking ahead, as the technician must look ahead, towards the future of the entertainment industry and the impact of technical progress on it, we must attempt to visualize the various possibilities which may arise, so that we can provide information for those whose duty it is to study the economic trend in relation to the ever changing needs and taste of the public served by the industry. Here we have in large screen television a new tool rapidly approaching the practical stage where it can be of value for entertainment and education. It is our duty to give guidance, as far as we can, so that it can be used to the best public advantage.

#### Conclusion

In conclusion I must express my appreciation of the work of my colleagues in Cinema-Television Ltd. who are engaged with me on this large screen theatre problem, to whom I must give grateful acknowledgment of their enthusiasm and whole-hearted co-operation.

#### Address of the Author:

A. G. D. West, MA, B Sc, FRPS, Hon. FBKS, Director, Cinema-Television Ltd., Worsley Bridge Road, Lower Sydenham, London, S. E. 26.

## Remarques sur l'analyse en télécinéma avec déroulement continu du film

Par S. Mallein, Paris

621.397.331.2

Quel que soit le genre d'analyseur utilisé, l'analyse s'opère toujours en définitive dans un plan où une distribution surfacique — optique ou électrique — est balayée par un sélecteur ponctuel.

Ce plan fixe, que nous appellerons le plan d'analyse, est par exemple le plan du film dans la fenêtre de projection avec le flying spot, le plan de la sonde avec le dissector, le plan de la mosaïque avec l'icône.

Par rapport à des axes fixes, la distribution comme le sélecteur peuvent avoir des mouvements propres, mais seul importe en définitive leur mouvement relatif.

En particulier, dans le cas du télécinéma, la distribution peut être affectée d'un mouvement vertical, et dans ce qui suit, nous ferons toujours abstraction du mouvement horizontal du sélecteur pour ne nous attacher qu'à l'étude des mouvements verticaux. Enfin, nous tiendrons compte de ce que, dans les récepteurs, le mouvement de balayage vertical est composé d'une succession de dents de scie, plus ou moins parfaites, mais en tout cas, toutes superposables, ayant par conséquent en particulier même amplitude et même durée.

Plaçons-nous, pour commencer, dans le cas idéal, où, dans le plan d'analyse, la distribution correspondant à une image du film est fixe pendant toute sa durée normale de projection,

et est remplacée instantanément par la distribution de l'image suivante.

Pour simplifier et clarifier cet exposé, nous donnerons le nom de «photos» aussi bien aux images du film qu'aux distributions qui en résultent dans le plan d'analyse et nous ne nous occuperons pas du grandissement optique ou électrooptique. Nous réservons le terme d'«images», aux images observées sur le récepteur de télévision dont chaque balayage vertical forme une «trame». Si l'entrelacé est d'ordre  $K$ , une image à linéature complète sera formée de  $K$  trames.

Soient enfin  $p$  et  $n$  respectivement les fréquences de photos et de trames,  $P$  et  $T$  étant les périodes correspondantes.

La fig. 1 (a) donne dans le cas idéal précité le mouvement  $y(t)$  du sélecteur dans le plan d'analyse par rapport à des axes fixes,  $h$  étant la hauteur d'une photo, en supposant pour simplifier que les retours du sélecteur sont instantanés.

On voit ainsi que les trames peuvent être formées par partie d'une photo, pour partie de la photo suivante, ce qui est sans inconvénient pour l'image de télévision. On sait, en effet, qu'il n'y a aucune relation nécessaire entre les fréquences  $p$  et  $n$ ; la première, normalement égale à 24 photos/s, doit seulement dépasser la valeur minimum à laquelle commence l'impression de continuité des mouvements des acteurs, c'est-