

Zeitschrift: Bulletin des Schweizerischen Elektrotechnischen Vereins, des Verbandes Schweizerischer Elektrizitätsunternehmen = Bulletin de l'Association suisse des électriciens, de l'Association des entreprises électriques suisses

Herausgeber: Schweizerischer Elektrotechnischer Verein ; Verband Schweizerischer Elektrizitätsunternehmen

Band: 77 (1986)

Heft: 17

Artikel: Technology trends in digital switching and transmission for broadband communications

Autor: Jönsson, Inge

DOI: <https://doi.org/10.5169/seals-904255>

Nutzungsbedingungen

Die ETH-Bibliothek ist die Anbieterin der digitalisierten Zeitschriften. Sie besitzt keine Urheberrechte an den Zeitschriften und ist nicht verantwortlich für deren Inhalte. Die Rechte liegen in der Regel bei den Herausgebern beziehungsweise den externen Rechteinhabern. [Siehe Rechtliche Hinweise.](#)

Conditions d'utilisation

L'ETH Library est le fournisseur des revues numérisées. Elle ne détient aucun droit d'auteur sur les revues et n'est pas responsable de leur contenu. En règle générale, les droits sont détenus par les éditeurs ou les détenteurs de droits externes. [Voir Informations légales.](#)

Terms of use

The ETH Library is the provider of the digitised journals. It does not own any copyrights to the journals and is not responsible for their content. The rights usually lie with the publishers or the external rights holders. [See Legal notice.](#)

Download PDF: 02.04.2025

ETH-Bibliothek Zürich, E-Periodica, <https://www.e-periodica.ch>

Technology trends in digital switching and transmission for broadband communications

Inge Jönsson

This paper discusses some of the fundamental technical long-term trends in fiber-optic transmission, digital broadband switching and video codecs. These trends will result in new ways of planning and dimensioning telecommunications networks.

Dieser Beitrag behandelt einige der fundamentalen Langzeit-trends der Faserübertragung, der digitalen Breitbandvermittlung sowie der Videocodierung. Aus diesen Trends werden sich neue Planungs- und Dimensionierungsweisen für die Telekommunikation herleiten lassen.

Cet exposé traite de quelques tendances fondamentales à long terme en transmission par fibres optiques, en commutation à large bande, ainsi qu'en codage vidéo. Ces tendances permettent d'envisager de nouveaux modes de planification et de dimensionnement en télécommunication.

Introduction

Digital broadband communications for commercial applications during the 80s are focusing mainly on high speed data traffic. Digital networks with an end-to-end capability of 2 Mbits/s are now being built to handle business applications such as CAD/CAM, high speed facsimile, etc. A small amount of traffic will also be generated by 2 Mbit/s video conferencing applications.

In the long run, however, starting during the 90s, the greatest requirements for large-scale broadband switched services will be generated by digital television and video telephony. This paper focuses on technology for this era, the era of the broadband ISDN.

The long-term objective to build a digital integrated broadband communications network for all types of telecommunications services is a vision offering a lot of opportunities but also harboring many problems (fig. 1). The whole service area for broadband ISDN is today still rather unknown. International standardization of broadband ISDN is a necessity not only for international broadband services but also to achieve mass production of cheap VLSI circuits for complex, broadband circuits in user terminals and

in switching and transmission equipment. Legal and national conditions influence to a high degree the introduction of broadband ISDN, mainly by delaying it.

The building of the broadband ISDN has to be financed. The development cost of system components for broadband ISDN will be very high and the investments in a network infrastructure which will be able to cater for mass usage of broadband ISDN services will be enormous.

The concept behind broadband ISDN is based on the assumption that the technology trends for digital switching and transmission will result in a suitably cost effective technology for digital broadband communications during the 90s. This paper will focus on technology trends, even though the main question for broadband ISDN is perhaps not hardware or software but "customer-where"? (Fig. 2.)

Optical fiber transmission systems

A major technical foundation upon which our hopes for a future mass market for interactive video communications services is built, is the remarka-

Fig. 1
Integrated services
broadband network
Long term structure

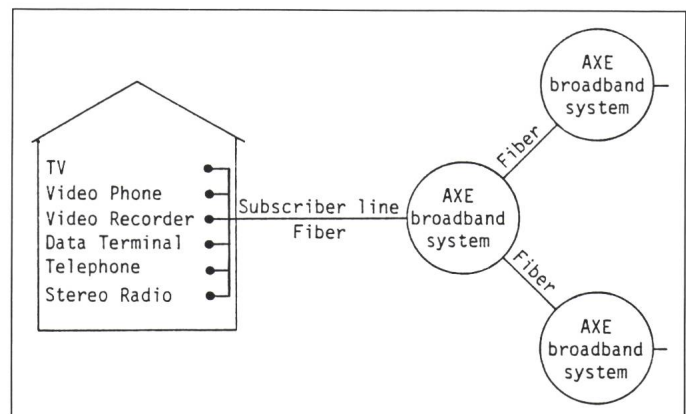

Adresse des Auteurs

Inge Jönsson, Ericsson Telecom,
S-12625 Stockholm, Sweden

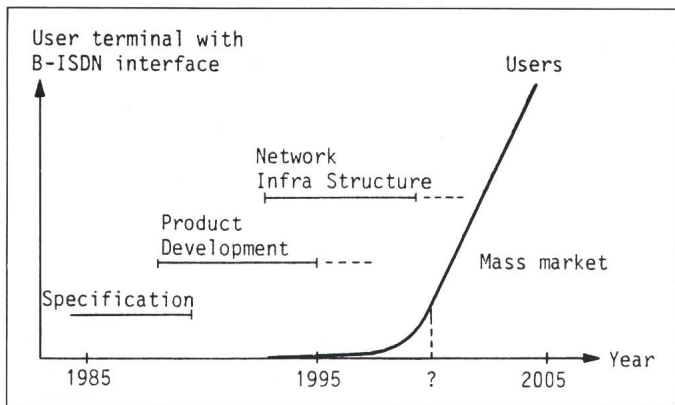

Fig. 2
Estimated market for terminals with a standardized B-ISDN interface

ble achievements of fiber optics in transmission. Today, optical fiber systems are very competitive for most applications when compared with microwave and satellite links. Satellites will still have a role to play in the networks of the future, e.g. for the broadcasting of television to rural areas and for some very specific fields of applications. The major part of our future networks will definitely, however, be based on optical fiber cables.

The state-of-the-art transmission rate for commercially available optical fiber systems is 565 Mbit/s. The future trend is towards still higher bit rates and longer repeater distances to further reduce transmission cost. One day a fiber-optic system might link Europe and America with no repeaters at all!

The keyword for the future is coherent communications. In coherent optical communications systems, the frequency or phase of the light is the carrier of information instead of the light power as in the direct detection systems of today. This requires stable, single-frequency lasers which today can only be implemented in the laboratory, but will soon become a commercial reality.

Coherent optical communications require more sensitive receivers which will allow the repeater spacing to be doubled yet again. But what is more attractive, is that these systems have a potential capacity of thousands of asynchronous channels, each carrying Gbit/s of data, i.e. total capacity of Tbit/s over one single-mode fiber. Having access to such a large number of high capacity channels will create a completely new way of thinking about telecommunications networks and services in the future (fig. 3).

The subscriber network

The existing installations for Cable-TV throughout the world are based

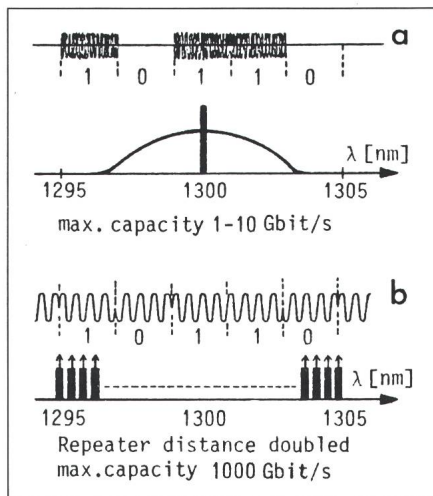

Fig. 3 Increase in transmission capacity
a Non-coherent
b Coherent

on coaxial cables using a tree-and-branch topology. This topology is not well suited for the future interactive services and also hampers the market penetration of Cable-TV operations. People prefer individual connection and subscription to TV channels.

The increasing number of new, national and international TV channels will stimulate the market for new Cable-TV networks and also make a number of existing installations obsolete due to their limited channel capac-

ity. Will it be economically possible to base these new Cable-TV installations on fiber optics in a star topology? Eventually yes!

For TV distribution between the head-end and the primary part of the subscriber network, cost effective fiber-optic transmission systems and codes are already commercially available. For the important last part, the secondary subscriber network, however, coaxial cables are still the most economical solution for TV distribution.

In order to pave the way for future broadband services, it would be attractive, if the secondary subscriber network, based on a star topology fiber-optic network, could be made cheap enough to compete with coaxial cables just for TV distribution alone. If this was possible considerable cost savings could be made for recabling in the future.

Thus, many of research and development activities are devoted to reducing the cost of the most cost intensive parts of the fiber-optics subscriber line. These parts are the network termination at the subscriber premises and the line terminal in the broadband switch. For broadband ISDN we possibly need a cheap subscriber line working up to the 1 Gbit/s area. We also need easy and cheap installation methods.

Cost effective single-mode systems for the subscriber network will be commercially available at the beginning of the 90s. These systems will represent the beginning of a new era in telecommunications.

Moving picture coding

A cornerstone for the digital integrated broadband network is digital video. Intensive research and standardization work is going on to define the coding algorithm for different picture categories (tab. I). By using advanced

Present standardization discussion

Tabel I

Moving picture quality	Bit rate (Mbit/s)		Examples of application
	Uncompr.	Compr.	
1	1000	140...800	High definition TV
2	216	70...140	Studio TV
3	140	30...70	Normal TV
3	140	30...70	Videophone A
4	40	0,384...1,92	Videophone B
5	5	0,064	Highly reduced resolution video

video codecs the transmission bit rate can be reduced. Knowledge of statistics of the picture signal and about the receiver (the visual system in the case of a human observer) can be utilized to omit a large amount of redundant information without any perceptible loss of picture quality. There is always, however, a trade-off between picture quality, transmission cost and coding complexity. In low bit rate coding, the ambition is to keep the unavoidable distortion as small as possible.

For distribution of TV and video films over the digital broadband network, codecs are required which reduce the bit rate without causing a deterioration in the picture quality. In the long run the aim is to achieve an improved picture quality compared with today's TV-picture. This is probably also essential if a mass market is to be acquired for video telephony.

One important question is the allocation of the video codec function in the network. One proposed solution is to have a common, cheap, high bit rate codec in the subscriber terminals, for all video services, and to have the more sophisticated codecs in a pool at the broadband switch. Depending on the service the subscriber wants, the relevant codec is automatically switched into the connection (fig. 4).

Many coding methods exist. Predictive coding and transform coding are the two major groups of coding. A combination of these methods gives a high compression ratio and facilitates smooth control of the picture quality over a large bit rate range. The maximum achievable coding compression with today's methods while maintaining a good picture quality is 10...100

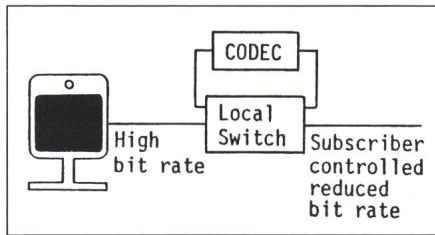

Fig. 4 Different codecs are switched in on demand by the subscriber for different services

times, if subsampling is used. At the beginning of the 90s we will see considerably cheaper but effective codecs implemented in CMOS for large-scale applications.

Switching systems for broadband applications

The broadband ISDN switching system will be the "brain" of the future network. Not only will it have to cater for all the telephony and narrowband-ISDN services which are under discussion today, but also for a great number of future broadband services which will be created during the coming years (fig. 5).

The switching systems must of course be able to switch broadband channels up to 140 Mbit/s both singly and in various combinations with narrowband channels. The software has to handle a vast number of different services and situations. The broadcast mode for the remote subscriber switch unit for 500...1000 subscribers, has a number of characteristics which are quite different from a normal telephony switch. One aspect is, for example when all the subscribers want to

change TV channel at the same time, the switching system must react very quickly.

Information transfer mode

One of the basic conceptual questions for the future broadband network is whether it should be based on circuit-oriented or on packet-oriented switching techniques. The answer is perhaps both.

Engineers in favour of a packet-oriented broadband network emphasize the importance of flexibility. Originally the objective behind the packet mode was to save transmission capacity but today the main argument is flexibility. Based on the packet mode it will be possible to build broadband networks which can handle different types of services independently of bit rates and traffic characteristics. We will achieve a decoupling between user services and network capabilities. This will allow for future new applications handled by specific customer equipment, regardless of network-oriented technical constraints. The drawback of this flexibility is an increase in network complexity.

Engineers in favour of a circuit-oriented broadband network argue that, due to the continuous nature of the video signals, the circuit mode is more appropriate and cost effective for transmission of video services. The packet mode, they say, is mainly for data communications; not for real time applications.

The most likely scenario is that circuit switching will be used for homogeneous, large scale services with high real time requirements. Typical exam-

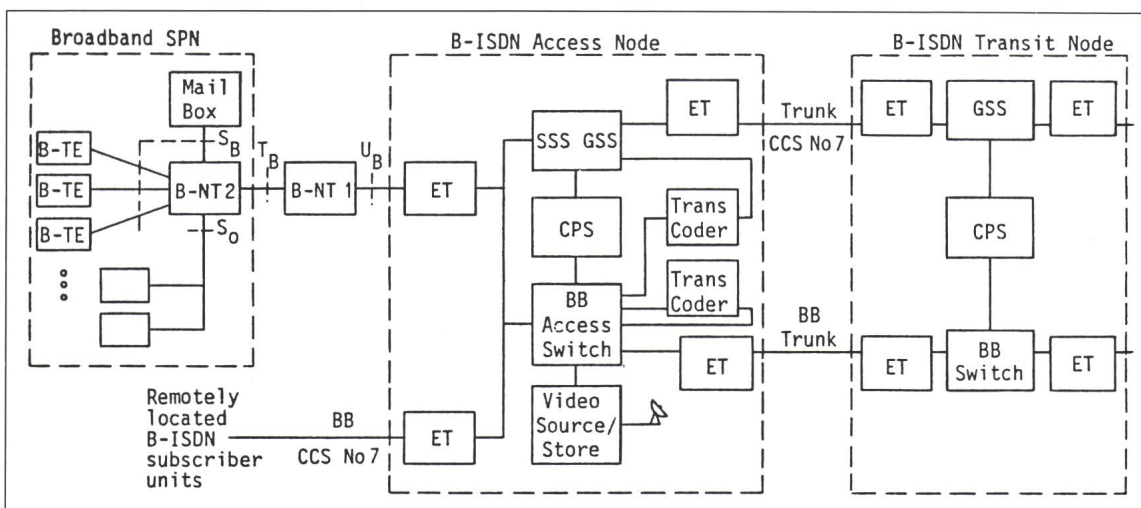

Fig. 5 AXE 10 system experiment structure for B-ISDN

Optical fiber single mode LED-PIN for 600 Mbits/s

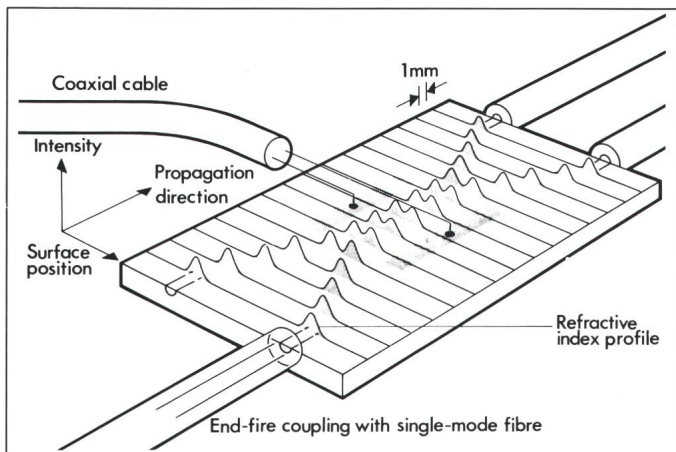

Fig. 6
Optoelectronic
directional coupler

ples are telephony and TV-distribution. Packet switching will be used for services which require bit-rate flexibility. Examples are all types of data services and services with variable, subscriber-controlled video compression.

Broadband switching matrixes

An interesting question concerning future switching systems is whether fiber-optics will penetrate into the switching systems. In the longer term, integrated optical devices which permit the switching of signals in the optical domain, may provide the ultimate situation for virtually unlimited band with switches. But even if very promising results have been achieved on optical switching elements, an all optical switching system for commercial applications seems not to be realistic before the end of this century (fig. 6).

It is important to widen the scope of the optical techniques in order to match the capabilities of electronics. Rather than being limited to simple functions such as light generation and modulation/demodulation, it is desired to introduce elements such as non-linear devices, digital logic devices, amplifiers, tunable oscillators, phase locked loops etc. Many of these devices have already been demonstrated in the laboratory, but problems such as how to implement timing and synchronization in the optical domain have received little attention even though they are crucial to the implementation of an all-optical switching system.

For the foreseeable future, switching systems for broadband ISDN will use electronic switching matrixes. ECL

matrixes are today the only commercially available technology for switching 140 Mbit/s channels. The disadvantage of ECL is its high power consumption.

The most promising technology for broadband switching matrixes is the CMOS technology. Chips with a basic 16×16 switching element will be commercially available in a few years. 64×64 elements will probably become available at the beginning of the 90s. With a 1μ CMOS technology, switching of 140 Mbit/s and beyond will be achieved.

Software

Broadband ISDN will enormously increase the number of functions expected of a telecommunications system and thus also the ways in which these may interact with each other. Software requirements, no doubt, present the greatest challenge for the broadband ISDN system design. Indeed, even in the narrowband ISDN the multiplication of services and user facilities immediately multiplies the complexity of a software problem that has not yet been solved in a truly satisfactory manner even for a simple telephone service (fig. 7).

The evolution of software technology during the last 20 years has of course contributed to the efficiency of switching systems development, but we still live with a number of programming difficulties. These can be summarized as follows: it takes much longer to design programs than anticipated, it is more complex to make changes to them than was hoped for, and programs may contain errors that are not discovered until after a long period of operation.

In order to improve software technology in the future, much work is going on in two directions; one evolutionary approach and one revolutionary approach.

The objective for the evolutionary approach is to improve the present software development environment. Today's switching systems are based on a technology defined by high-level languages such as PASCAL, CHILL, ADA, PLEX. These languages support structured programming, some form of abstract data types and to a large extent modularisation and parallel processes. This technology is much less flexible than users and developers had hoped for. There are, however, a number of techniques becoming available which will improve the situation.

The most important tool is perhaps an improved and more flexible relational data base for administration and retrieval of the switching system information. A large switching system represents a huge amount of information in the form of source programs, descriptions and documents of all kinds. When designing additional functions for an existing system, it is absolutely essential to have rapid and reliable information retrieval of the existing software units and their dynamic interfaces.

The design process will also become more efficient through tools which are more interactive and which use graphics to a large extent. Application-oriented languages which are tailor made for services, protocols, maintenance etc. will considerably reduce the development cost and time for an additional function.

The objective of the revolutionary approach is to create new software

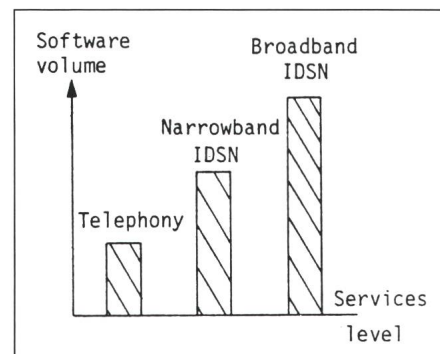

Fig. 7 Increase of the software complexity for B-ISDN

technologies. Even though vast amounts of research work is being done throughout the world, we are still waiting for a breakthrough for a software technology which can drastically increase the efficiency in development and maintenance of very large programming systems and which ensure essentially error-free programs.

Many of the ideas originating from computer science research labs are expected to radically improve the quality and reduce the time required to design and produce large software systems. The ideas behind the Japanese 5th Generation Computer initiative (its

technical ideas are in fact mainly of European origin) have lead to a new generation of programming languages (the so called Declarative Languages). Use of these languages compared with traditional languages (so called Imperative Languages) usually results in programs that are clearer and easier to understand than equivalent programs written in traditional languages.

Languages that allow parallel processes to be described in a natural way, architectures for the efficient execution of such languages and formal methods applied to the design of telecommunications switching systems, will greatly influence future systems.

Final remarks

The telecommunications industry will apply a great deal of its research and development resources during the coming decade to transform the broadband services scenario into a commercial reality.

The interactive broadband services will initially be used for business communications. But the technology will mature during the 90s allowing for low cost mass production, and then, the services will spread to residential customers.

Face-to-face communications will be a reality for everyone.