

Zeitschrift: Schweizerische Polytechnische Zeitschrift
Band: 1 (1856)
Heft: 3

Anhang: Tafeln

Nutzungsbedingungen

Die ETH-Bibliothek ist die Anbieterin der digitalisierten Zeitschriften. Sie besitzt keine Urheberrechte an den Zeitschriften und ist nicht verantwortlich für deren Inhalte. Die Rechte liegen in der Regel bei den Herausgebern beziehungsweise den externen Rechteinhabern. [Siehe Rechtliche Hinweise.](#)

Conditions d'utilisation

L'ETH Library est le fournisseur des revues numérisées. Elle ne détient aucun droit d'auteur sur les revues et n'est pas responsable de leur contenu. En règle générale, les droits sont détenus par les éditeurs ou les détenteurs de droits externes. [Voir Informations légales.](#)

Terms of use

The ETH Library is the provider of the digitised journals. It does not own any copyrights to the journals and is not responsible for their content. The rights usually lie with the publishers or the external rights holders. [See Legal notice.](#)

Download PDF: 14.03.2025

ETH-Bibliothek Zürich, E-Periodica, <https://www.e-periodica.ch>

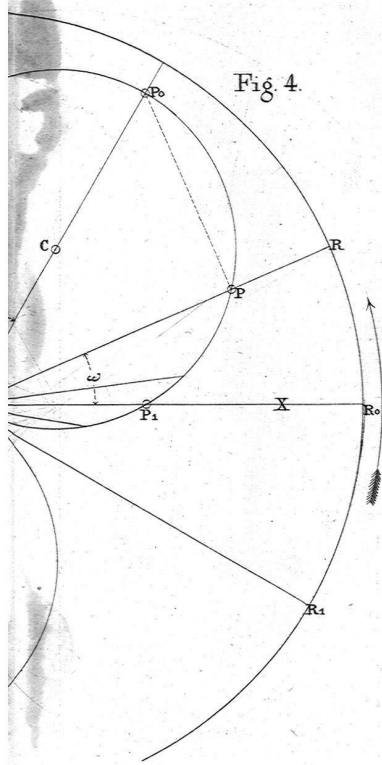

Fig. 4.

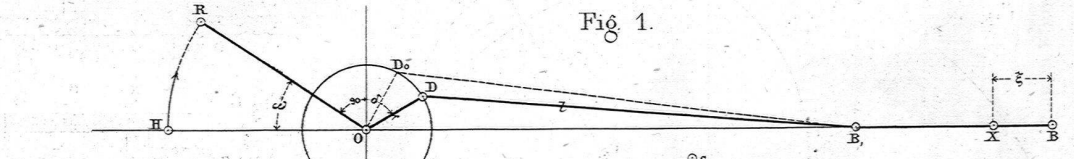

Fig. 1.

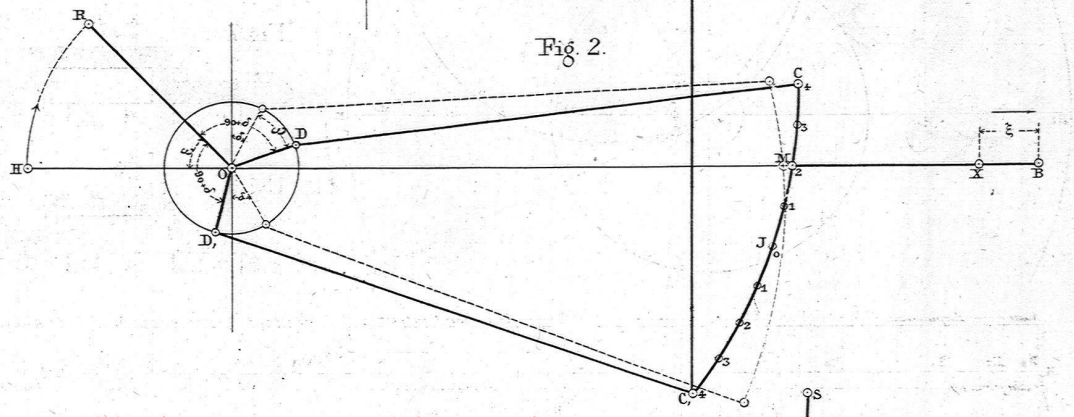

Fig. 2.

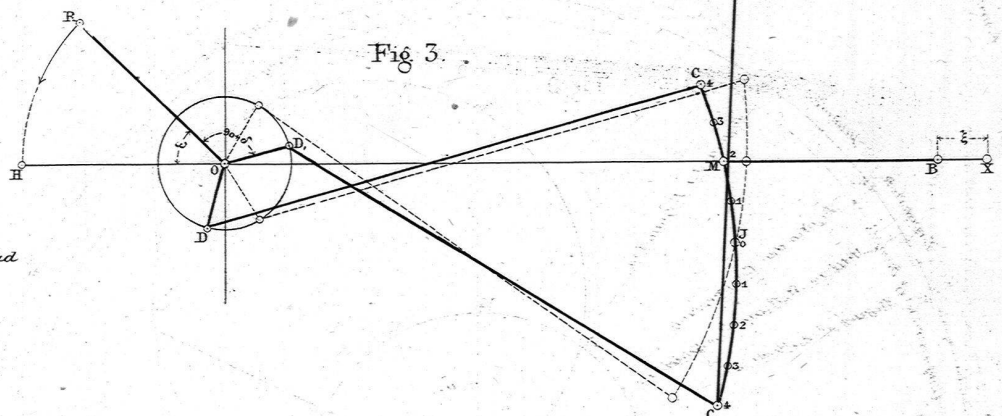
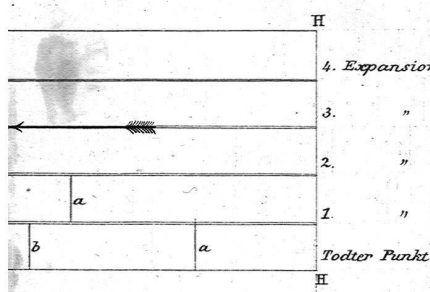
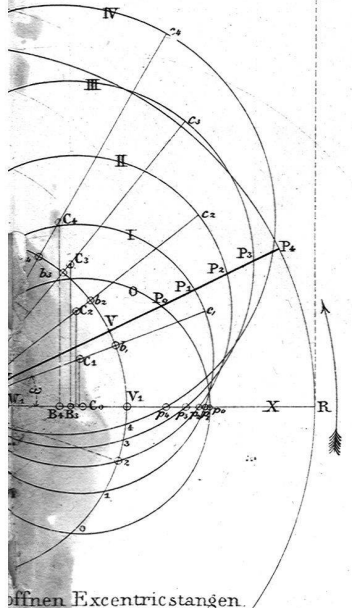

Fig. 3.



4. Expansionsgrad
3. "
2. "
1. "
Totter Punkt



offnen Excentricstangen.

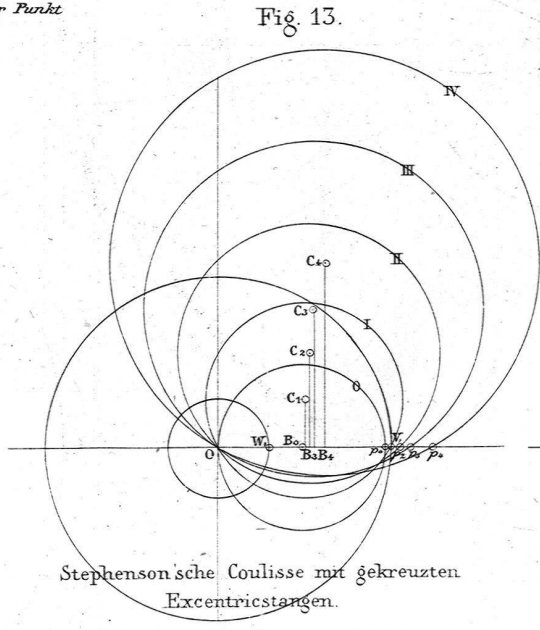

Fig. 13.

Stephenson'sche Coulisse mit gekreuzten Excentricstangen.

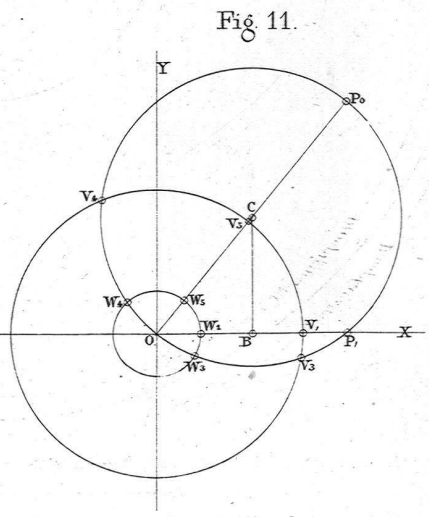

Fig. 11.

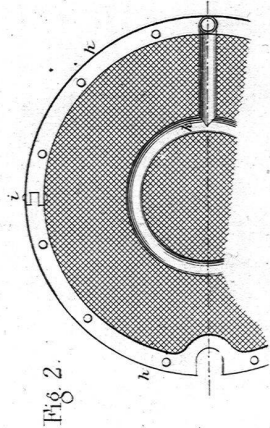
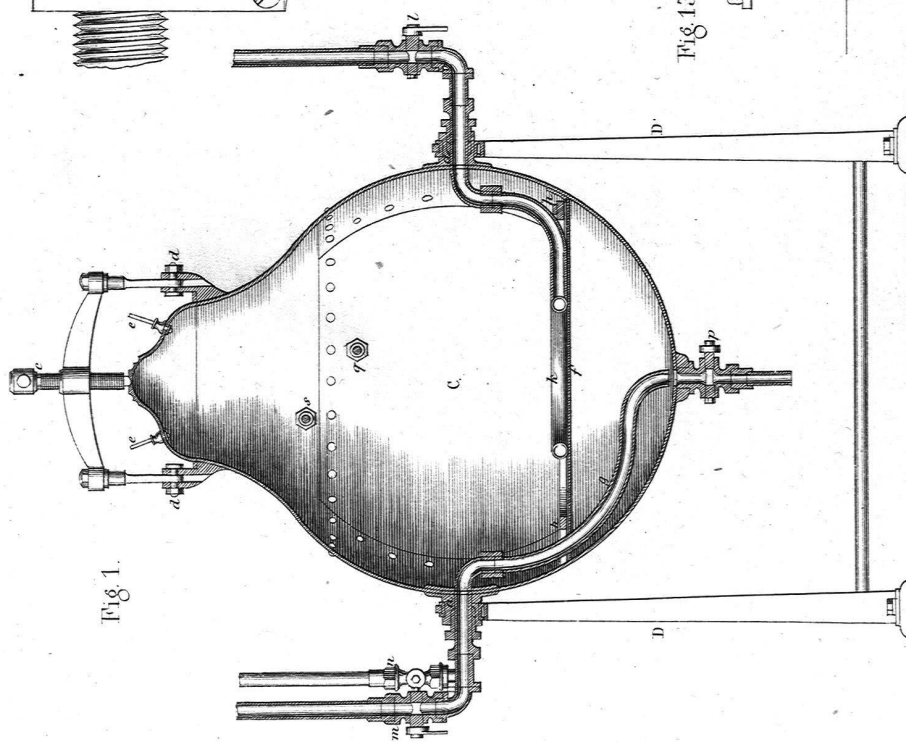

Fig. 3.

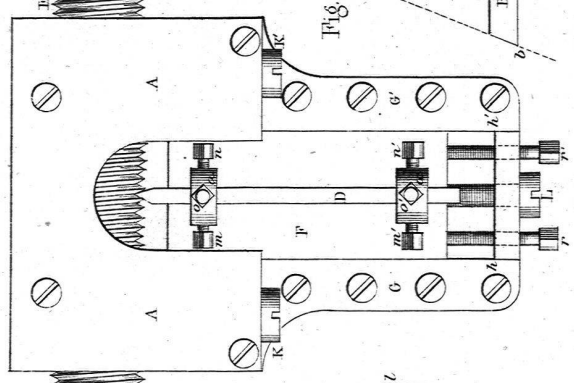

Fig. 4.

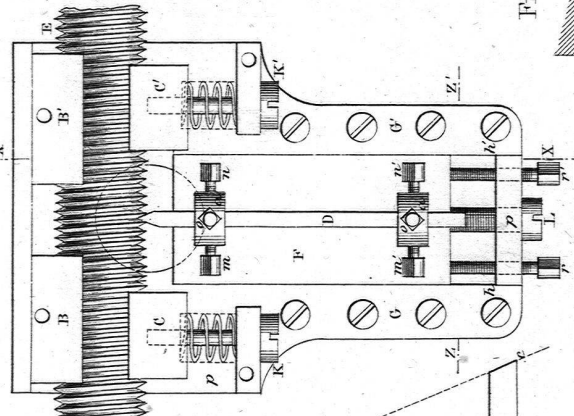
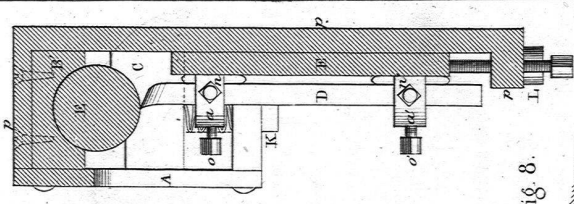

Fig. 5.



Steinwäge von Chevallier

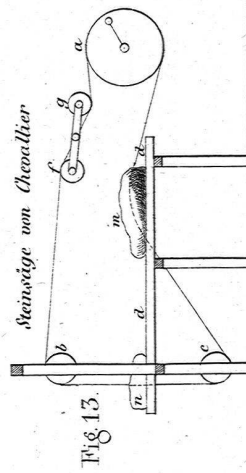

Fig. 6.

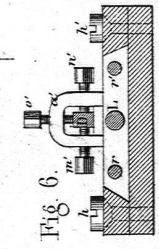

Fig. 11.

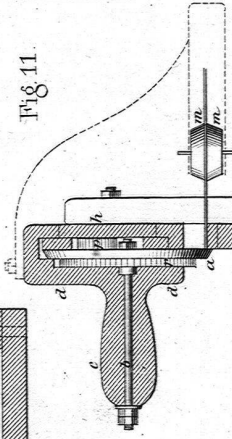

Fig. 12.

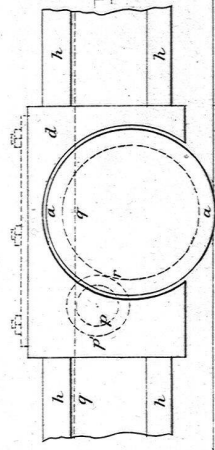

Fig. 9.

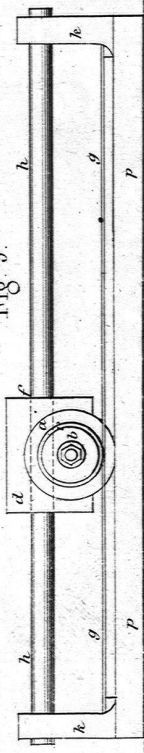
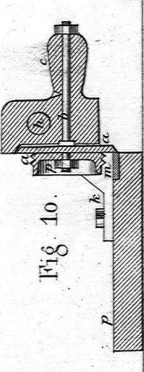

Fig. 10.



Leere Seite
Blank page
Page vide

SCHWEIZERISCHE EISEN-
GEFÜHRTE und IM BAU BEGRIFFENE LINIEN.

MAI 1856.



Schweiz. polytechn. Zeitschrift.

Band I, Taf. II

Top Anstalt v. J. Wurster u. Comp. in Winterthur.

Leere Seite
Blank page
Page vide

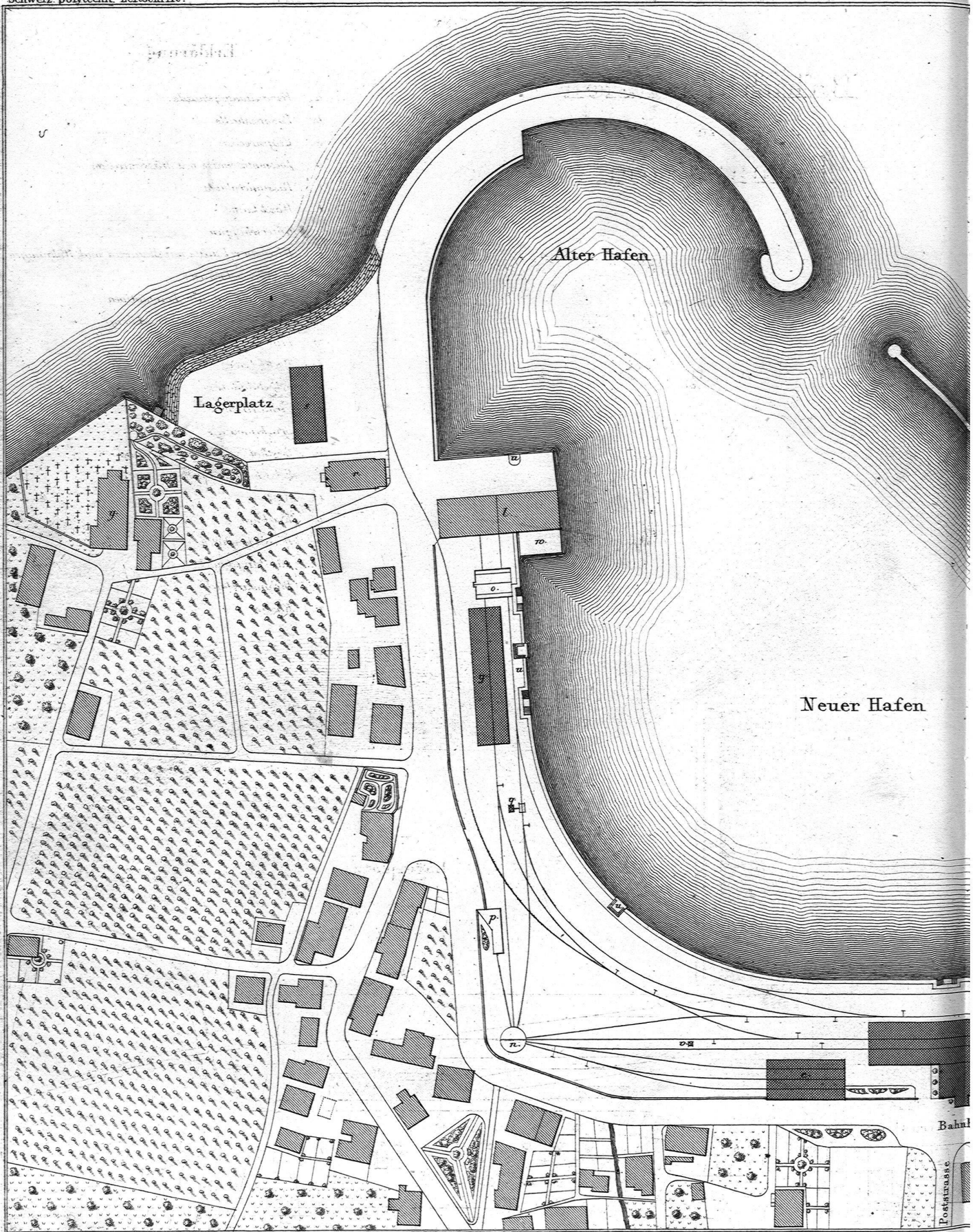

Bahnhof u. Hafen

zu

Romanshorn.

B o d e n S e e

Lagerplatz

Erklärung

- a. Verwaltungsgebäude
- b. Personenhalle
- c. Wagenremise
- d. Locomotorenremise mit Wasserstation
- e. Passagierabtritt
- f. Waschküche
- g. Güterschuppen
- h. Wagenwerkstätte mit Magazin und Wohnungen
- i. Arbeiterwohnhaus
- k. Holzschuppen für Locomotiven
- l. Lagerhaus (dem Canton gehörig)
- m. Pfahldamm
- n. Drehscheibe
- o. Schiebepöhl
- p. Viehladrampe
- q. Brückenvoage
- r. Gasthof zum Schweizerhaus
- s. Holzschuppen für die Dampfboote
- t. Bach
- u. Krähen
- v. Wasserkrähen
- w. Landungsbrücke
- x. Bahnwartbude
- y. Kirche

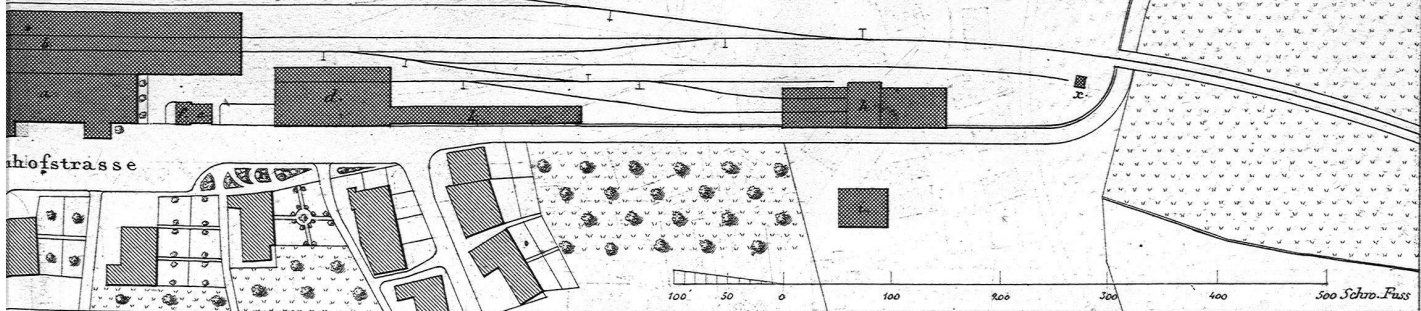

Quaimauer:

Fig 4.
Querschnitt durch die Mauer im Bogen mit Verstärkungsfeiler;

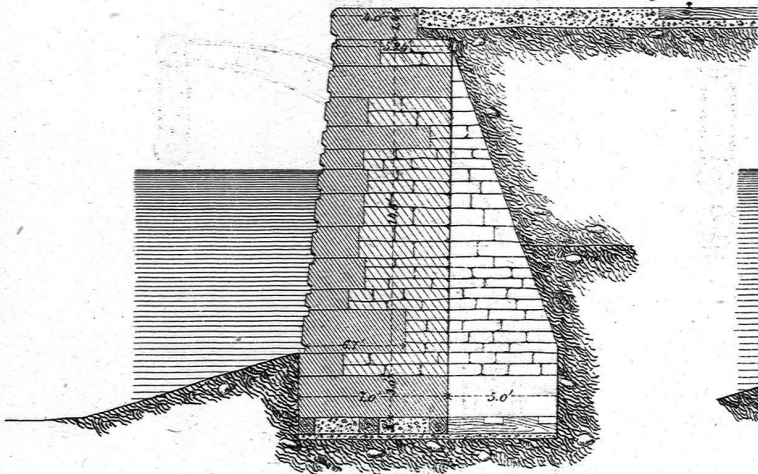

Fig 3.
durch eine Doppeltreppe

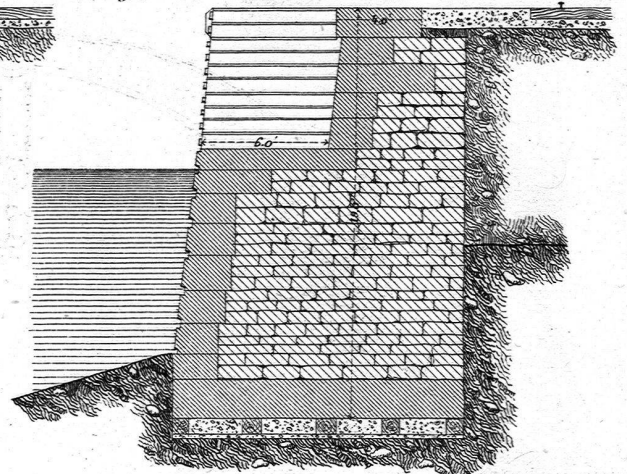
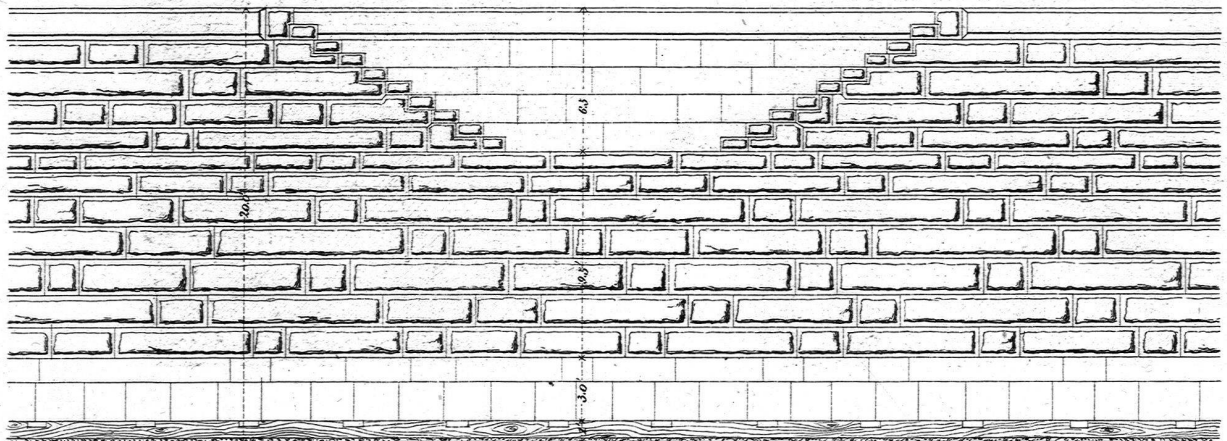
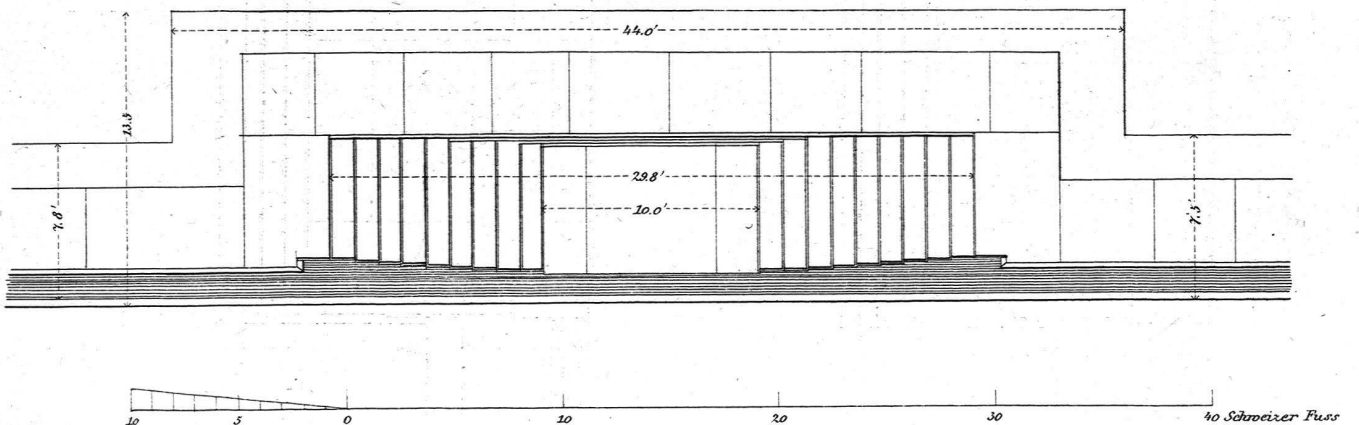

Fig 2.



Doppeltreppe

Fig. 1.



ROMANSHORN.

Krahnen

Fig. 7.

Fig. 5.

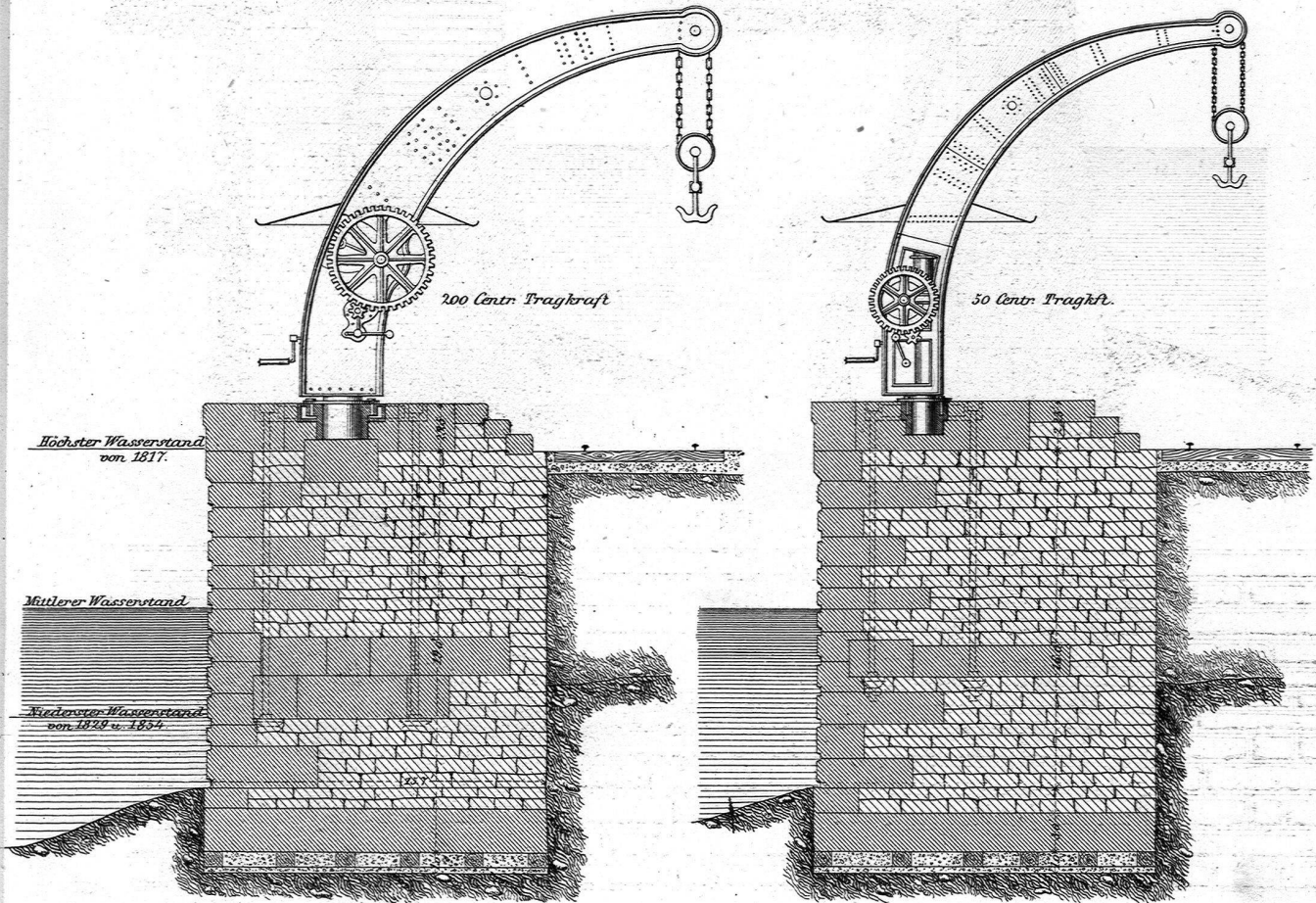
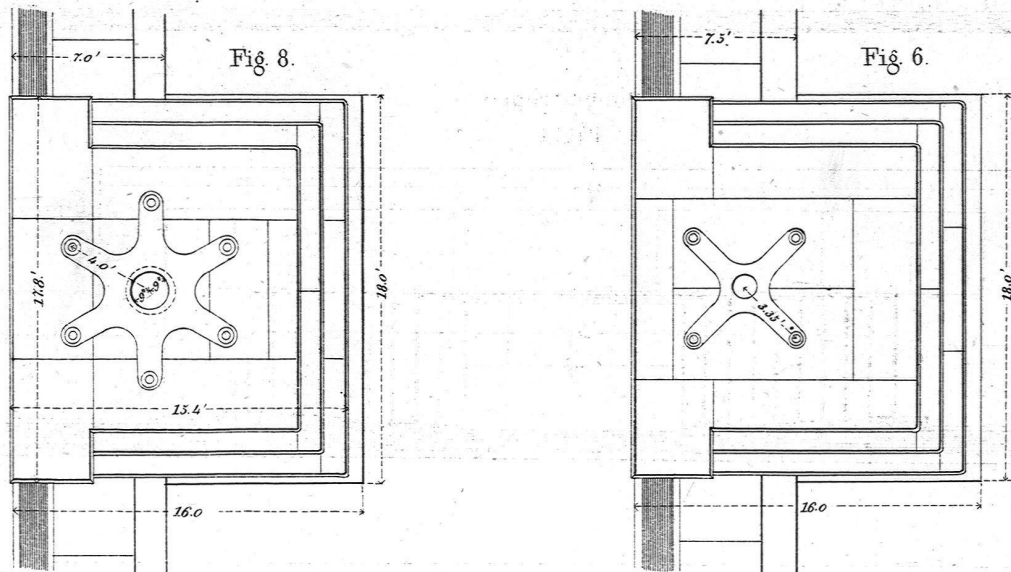

Fig. 8.

Fig. 6.



Pfahldamm

Fig. 3.

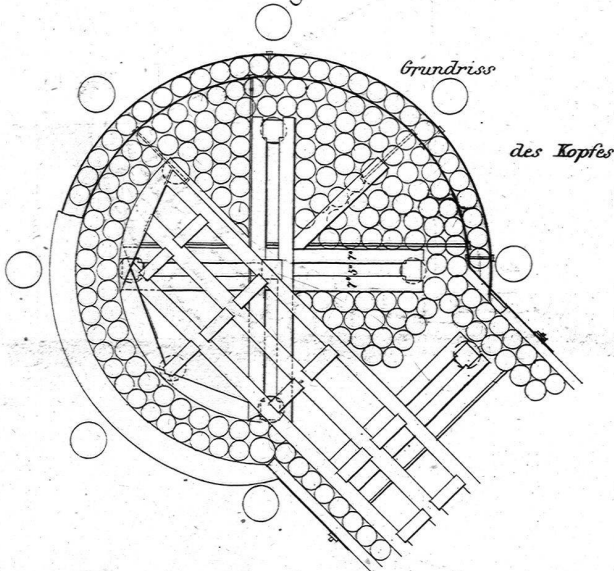
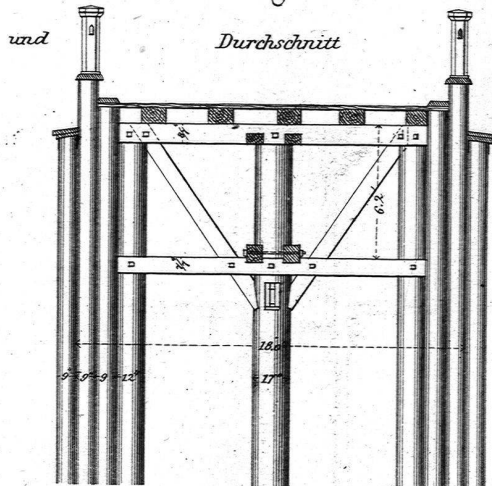

Fig. 4.



Durchschnitt des Pfahldammes

Fig. 2.

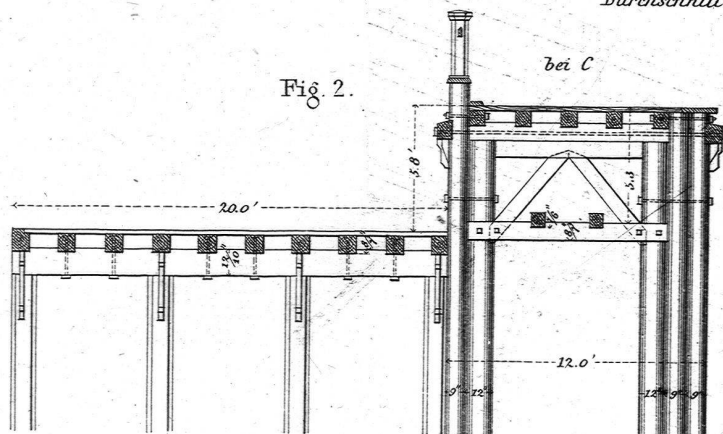
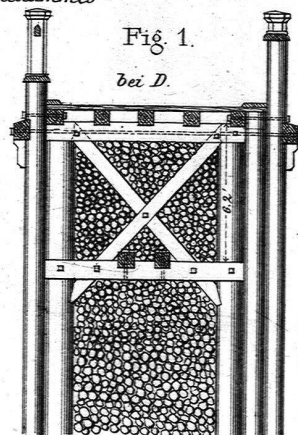
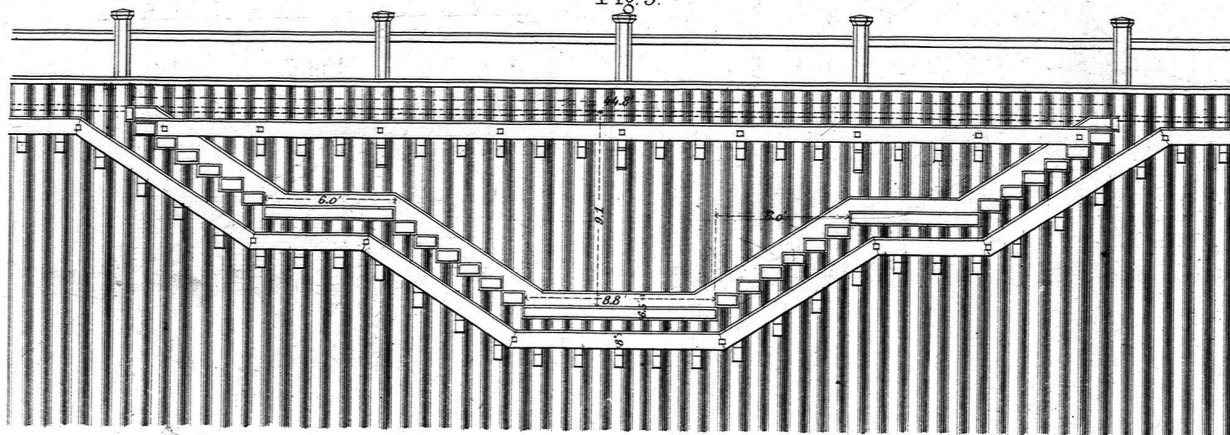

Fig. 1.



Pfahldammtreppe.

Fig. 5.



OMANSHORN

Fig. 6.

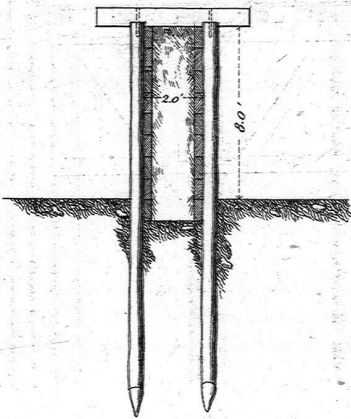

Fig. 10.

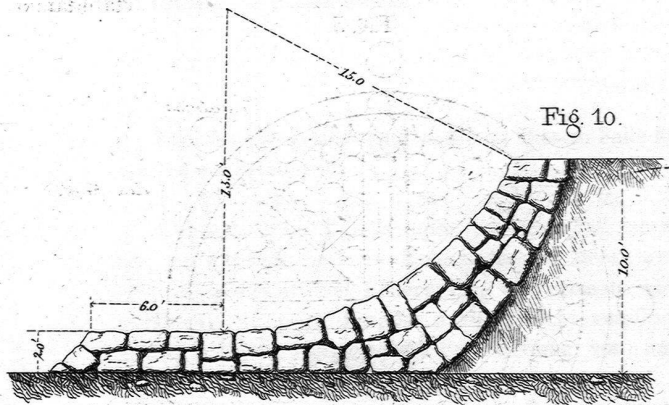

Fig. 9.

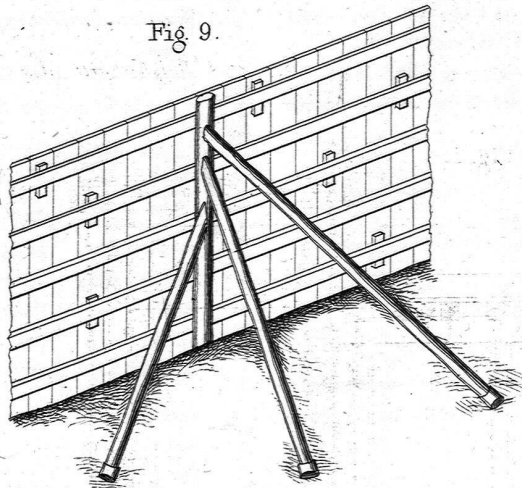

Fig. 8.

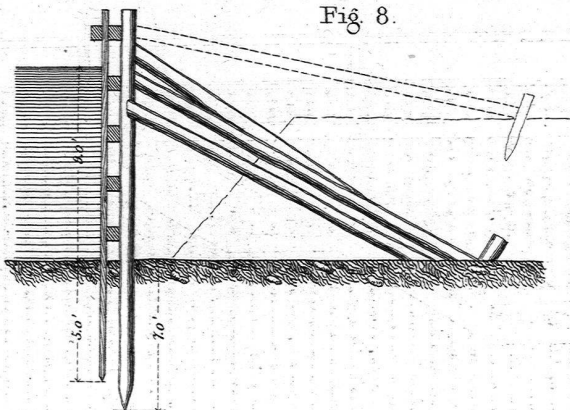

Fig. 7.

